

 **IO-Link**



Pyrometer
*CellaTemp PKL 63,
PKF 66/67, PK(L) 68*

Ident no.: 1086021 06/2017

Content

1	General	5
1.1	Information about this manual	5
1.2	Explanation of symbols	5
1.3	Liability and Warranty	5
1.4	Copyright	6
2	Safety	6
2.1	Intended use	6
2.2	User's responsibility	6
2.3	Safety requirements	6
2.4	Electromagnetic Compatibility	7
3	General Description	7
4	Models	8
4.1	One-colour measurement	8
4.2	Two-colour measurement	8
5	Function	9
5.1	Analogue output	9
5.2	Switching threshold OUT1	10
5.3	Output signal	10
5.4	Upper threshold delay	10
5.5	Lower threshold delay	11
5.6	Switching functions	11
5.7	Internal signal processing	11
5.8	Switching threshold OUT2	12
5.9	Dirt alert	12
5.10	Sync-pulse	13
5.11	Inner device temperature	13
5.12	Output signal	13
5.13	Upper threshold delay	13
5.14	Lower threshold delay	14
5.15	Setting the emissivity ratio (two-colour mode)	14
5.16	Emissivity of materials (one-colour mode)	14
5.17	Transmission factor (one-colour mode)	15
5.18	IO-Link	15
6	Electrical connection	16

7	Shielding and Grounding	17
7.1	Equipotential bonding	17
8	Operating controls and display	18
9	Menu	19
9.1	Process value display	19
9.2	Analogue output	19
9.3	Digital threshold OUT1	20
9.4	Digital threshold OUT2	21
9.5	Two-colour mode	22
9.6	One-colour mode	23
9.7	Advanced Features	24
10	Menu explanation	25
10.1	Analogue output	25
10.2	Switching threshold OUT1	25
10.3	Switching threshold OUT2	26
10.4	Measurement acquisition (two-colour mode)	27
10.5	Measurement acquisition (one-colour mode)	28
10.6	Advanced Features	28
11	Setup	29
11.1	Two-colour mode	29
11.2	One-colour mode	30
12	Aligning and focusing the fiber optic head	31
12.1	Safety instructions and precautions	32
13	Operating parameters	33
13.1	Setting parameters – general information	33
13.2	Damping function	34
13.3	Peak hold function	35
13.4	DTD function	36
13.5	Reset all parameters to factory settings	38
14	Operation	38
14.1	Ambient temperature	38
14.2	Error indications	39

15	Theory of Non-Contact Temperature Measurements.....	39
15.1	Advantages fo Non-Contact Temperature Measurement.....	39
15.2	Measurements an Black Bodies (Cavity Radiators).....	40
15.3	Measurements of Real Radiators	40
15.4	Measurements errors	41
16	Ways to determine emissivity	41
16.1	Emissivity coefficient tables (One-colour mode)	42
17	Maintenance	43
17.1	Cleaning the pyrometer lens	43
18	Shipping, packaging and disposal	43
18.1	Inspection after shipping	43
18.2	Packaging	43
18.3	Disposal of the old devices	43
19	Accessories	44
20	General technical data	45
21	Device-specific technical data and field of view diagrams	46
22	Factory settings	57
23	Copyright	59

1 General

1.1 Information about this manual

The Operating Manual shall enable the user to properly install the pyrometer and the required accessories.

Before starting installation, be sure to read and understand this entire manual, in particular the chapter on safety! The instructions contained in this manual, especially those concerning safety, as well as site specific regulations governing UV radiation must be complied with at all times. It is imperative to comply with the safety instructions and the accident protection regulations valid for the area of application.

1.2 Explanation of symbols

Important safety-related references in this manual are marked with a symbol.

ATTENTION

This symbol points out guidelines. If you do not observe them, the device might be damaged, malfunctioning or even fail to operate.



CAUTION

This symbol points out hints and information which should be heeded for efficient and trouble-free operation

▶ **Action**

This symbol instructs the operator to take action.

> **Reaction, Result**

This symbol indicates the result of the action taken.

1.3 Liability and Warranty

All information compiled in this manual is in accordance with applicable regulations. The statements made are based on state-of-the-art technology and reflect our extensive knowledge and many years of experience.



Always carefully read this Operating Manual before beginning any work on or with the instrument, especially prior to installation and initial setup! The Manufacturer shall not be held liable for any damages or malfunctions arising from a disregard of the warnings and instructions contained herein.

1.4 Copyright

This Operating Manual should be treated as confidential. It is solely intended for use by persons involved with the instrument. This manual may not be made available to a third party without prior Manufacturer's consent. Please contact the Manufacturer if the need should arise.

2 Safety

This chapter outlines all important safety aspects to be considered for optimum employee protection and to ensure safe and reliable operations.

2.1 Intended use

The pyrometer is solely intended for use as described in this manual. Operational safety can only be ensured when the instrument is used for its intended purpose.



The use of the pyrometer for any other purpose beyond what is specified in this manual is prohibited. Using the instrument in any other manner will be considered as improper.

The manufacturer is only liable for damage that occurs during correct use. The prerequisite for any liability, however, is that the cause of the damage is due to a defective product and the defect in the product was caused by the manufacturer.

2.2 User's responsibility

The pyrometer may only be used when it is in perfect working condition.

2.3 Safety requirements

The instrument operates at low voltage (18 – 34 V DC). The power supply unit must conform to directive EN50178, SELV, PELV.

2.4 Electromagnetic Compatibility

The devices comply with the essential safety requirements of the Electromagnetic Compatibility Directive 2014/30/EU (EMC Act).

When connecting a power supply unit, make sure that it also conforms to these standards. Radio interference may arise if the pyrometer is interconnected with such peripheral devices which have not been properly interference-suppressed. This may necessitate additional interference suppression measures.

3 General Description

The two-colour pyrometer PKx 6x detects temperatures and monitors temperature ranges without contact.

The sensor detects the infrared energy radiated by a hot object and converts this to an electric switch signal.

The advantage of this technique is that there is no mechanical contact between the sensor and the hot object.

The instrument is suitable for the following applications:

- Measurements at moving or hard-to-reach objects
- Measurements at surface-treated or voltage-carrying objects
- Measurements at sticky materials such as dough or aggressive chemicals
- Applications requiring fast response times.

The PKx 6x ratio pyrometer is designed for use in harsh industrial environments and offers a high level of functionality. The instruments are splash-proof according to IP65 (DIN 40050). The pyrometer has an analog output and a switch contact that can be used depending on the configuration as opener or closer.

Moreover, the pyrometer PKL is equipped with a LED spot light. The LED spotlight shows the real size of the target spot.

4 Models

Model	Temp. range	Focus distance	Measuring field size	LED spot light
Two-colour pyrometer with fixed focus optics				
PK 68 AF 1	550 - 1400 °C	1.5 m	Ø 21 mm	no
PKL 63 AF 1	650 - 1600 °C	0.21 m	4.1 x 0.6 mm	yes
PKL 63 AF 2		1.0 m	18.5 x 2.7 mm	yes
PKL 68 AF 1		0.21 m	Ø 1.2 mm	yes
PKL 68 AF 2		1.0 m	Ø 5.6 mm	yes
Two-colour pyrometer with fibre optics and measuring head				
PKF 66 AF 1	700 - 1800 °C	0.2 m - ∞	190 : 1	no
PKF 66 AF 2		1.08 m - ∞	Ø 5.6 mm	no
PKF 66 AF 3		0.12 m - ∞	85 : 1	no
PKF 66 AF 4		0.033 - 0.045 m	50 : 1	no
PKF 66 AF 5		1.8 m	Ø 8 mm	no
PKF 67 AF 5	600 - 1400 °C	1.8 m	Ø 16 mm	no

4.1 One-colour measurement

This measurement method is suitable for measurements of targets in areas where no sighting obstructions, either solid or gaseous, exist. The target must fill the entire target spot.

4.2 Two-colour measurement

The two-colour measuring method detects the infrared radiation at two different wavelengths and calculates the quotient from the values obtained.

This measurement method is suitable for measurements of targets that are partially obscured (either intermittently or permanently) by other objects, openings, screens or viewing windows that reduce energy, and by dirt, smoke, or steam in the atmosphere. The two color mode can also be used on targets that do not completely fill the target spot, provided the background is much cooler than the target.

5 Function

The pyrometer measures the temperature without contact to the target.

The infrared sensor is equipped with an analogue output and two open collector outputs. The instrument's display panel shows the measured temperature.

- Analogue output 0/4 - 20 mA
- OUT1: Switching signal dependent on the set temperature
- OUT2: Switching threshold dirt alert, sync-pulse or inner device temperature

EN

5.1 Analogue output

The pyrometer is equipped with an analogue output 0/4...20 mA. The maximum load is 500 Ω . The output current is linear to the measured temperature. The source must be defined before the current output can be used.

The following sources are available:

- Two-colour mode: [R0] \rightarrow [R0S] = 900t.
- One-colour mode: [R0] \rightarrow [R0S] = SP E c.

Within the overall measuring range, the required measuring range can be set to °C or °F using parameter [R0 -] (scale beginning) and parameter [R0 -] (scale end). There is also the possibility, to switch OUT2 between 0 - 20 mA and 4 - 20 mA.

Scale beginning [R0] \rightarrow [R0 -]

Scale end [R0] \rightarrow [R0 -]

Change 0/4 - 20 mA [R0] \rightarrow [R004] = 0 - 20/4 - 20

First, the beginning of the scale [R0 -] in °C or F is entered, then the end of the scale [R0 -]. By changing [R0 -] also changes [R0 -], so that the range remains the same. If [R0 -] is increased so far, that the range can not be adhered to, as [R0 -] would otherwise exceed the maximum, [R0 -] is kept at its maximum. If [R0 -] is then reduced again, [R0 -] is also immediately reduced again. The minimum span is given in the technical data of the respective device.

5.2 Switching threshold OUT 1

OUT1 changes its switching status when the configured upper and lower thresholds [d 1SP, d 1rP] are exceeded. The source d 1S defines the signal at the output Out1.

Two sources are available:

- Two-colour mode: [d 1] → [d 1S] = 9006.
- One-colour mode: [d 1] → [d 1S] = 5PEc.

First set the upper temperature value of the switching point [d 1SP]. The temperature can be defined in °C or °F according to the unit setting. Then set the lower threshold [d 1rP]. When you adjust the upper threshold [d 1SP] the lower threshold [d 1rP] will change accordingly. The span remains the same. If [d 1SP] is lowered to a value where the span cannot be maintained (as [d 1rP] would then fall below its minimum value), the [d 1rP] is kept with its minimum value.

If [d 1SP] subsequently increases again, [d 1rP] also immediately increases. The minimum distance between [d 1SP] and [d 1rP] is 2 K.

5.3 Output signal

The following switching functions can be selected:

- Normally open contact: [d 1] → [d 1Fn] = no (normally open)
- Normally closed contact: [d 1] → [d 1Fn] = nc (normally closed)

5.4 Upper threshold delay

Once the sensor has detected a temperature which exceeds the switching threshold [d 1SP] the time delay [d 1dS] starts running. When this delay period has elapsed, the output OUT1 activates switching. This status is maintained until the lower threshold [d 1rP] is violated. If this occurs before the time delay has elapsed, the delay will reset. This function can be used, for example, to suppress spurious impulse signals at the output.

- Upper threshold delay: [d 1] → [d 1dS] = 0...10 sec.

5.5 Lower threshold delay

- The output impulse can be lengthened to make sure that the output impulse is correctly identified, e.g. by a downstream control system.
- Lower threshold delay: $[d \downarrow] \rightarrow [d \downarrow d \uparrow] = 0 \dots 10 \text{ sec.}$

5.6 Switching functions

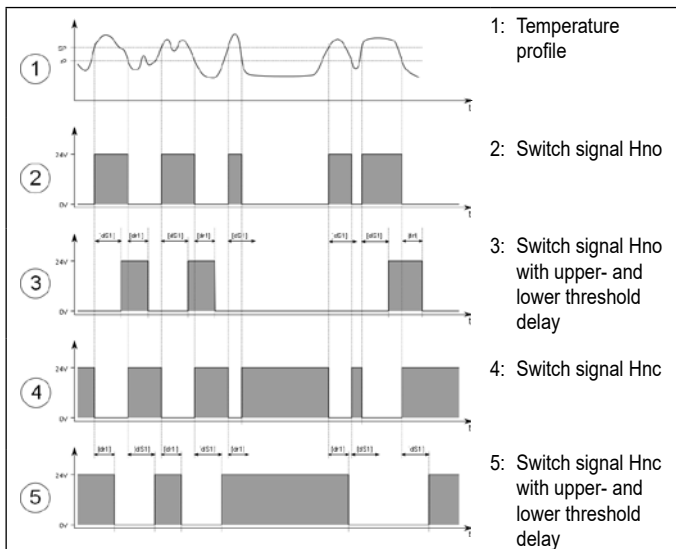

EN

5.7 Internal signal processing

Temperature

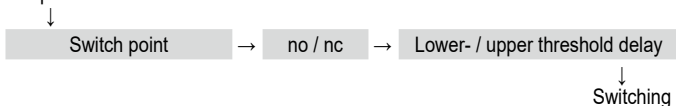

5.8 Switching threshold OUT2

OUT2 changes its switching mode in relation to the set function.

The following functions are available as a source for OUT2:

- Dirt alert
- Sync-pulse
- Inner device temperature

5.9 Dirt alert

A dirt alert function is available to ensure a safe measurement for the PKx 6x pyrometer. The dirt alert function warns the user if, for example, the lens, an attached protective glass or the sighting cone of the pyrometer gets dirty during a measurement.

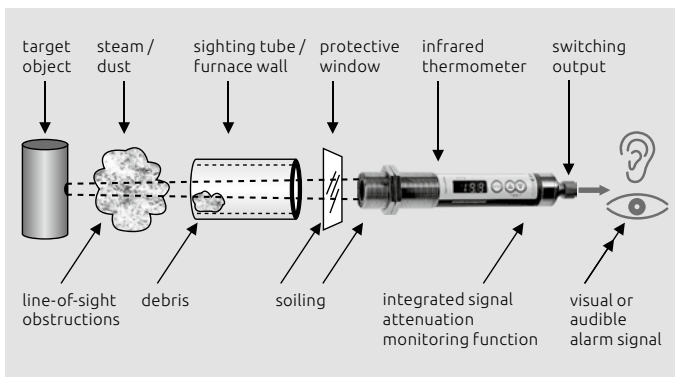

The dirt alert is activated with parameter [d2] → [d25] → dirt. The dirt alert is a warning function. This warning will become active when the set threshold [9] → [9.drt]. During measurements of discontinuous processes this warning is only active when the target object is detected by the pyrometer and the threshold is violated.



The parameter [d1 r t] dirt alert should be set to a signal intensity of 0.5 x. The pyrometer will stop to calculate the ratio temperature when the disconnection threshold [Q] → [Q.L, N].



The current signal strength can be displayed with parameter Q signal strength [Q] → [Q.S, G].

5.10 Sync-pulse

With active memory function d t d, a sync pulse is generated when the threshold is violated. Further details are given in chapter 13.4).

5.11 Inner device temperature

If the internal temperature of 75 °C is exceeded, the switching mode of switching output OUT2 changes according to its configuration. When the internal temperature is < 70 °C, the switching output OUT 2 switches back to its original state.

5.12 Output signal

The following switching functions can be selected for dirt alert, signal strength and inner device temperature:

- Normally open contact [d 2] → [d 2F n] = n o (normally open)
- Normally closed contact [d 2] → [d 2F n] = n c (normally closed)

5.13 Upper threshold delay

Once the sensor has detected a temperature which exceeds the switching threshold [d 2S P] the time delay [d 2d S] starts running. When this delay period has elapsed, the output OUT1 activates switching. This status is maintained until the lower threshold [d 2r P] is violated. If this occurs before the time delay has elapsed, the delay will reset. This function can be used, for example, to suppress spurious impulse signals at the output..

- Upper threshold delay: [d 2] → [d 2d S] = 0...10.0 sec.

5.14 Lower threshold delay

The output impulse can be lengthened to make sure the output impulse is correctly identified, e.g. by a downstream control system.

Lower threshold delay: [d 2] → [d 2 d r] = 0...10.0 sec.

5.15 Setting the emissivity ratio (two-colour mode)

The difference between measured temperature and true temperature can be compensated by changing the emissivity ratio. Make this adjustment for selective interferences or when the emissivity for wavelength 1 and wavelength 2 will be different because of the material that is being measured.

- Emissivity ratio [9] → [9 E S P] = 80 - 120 %



The pyrometer has a quick adjustment feature to set the emissivity ratio. In process value mode, the value can be set directly with the keys ▲ or ▼. It is not necessary to access the menu. When simultaneously pressing the MODE key, the display shows the current measuring temperature while the emissivity coefficient continues to be adjusted in the background. This is an easy way to determine the emissivity when the object temperature is known. The changed values are directly adopted.

5.16 Emissivity of materials (one-colour mode)

The pyrometer reacts to the thermal energy (infrared radiation) emitted by an object. The ability to radiate heat depends on the type of material and its surface properties. A description of the calculation of emissivity is in Chapter 16/ Page 41. The ability of a body to emit infrared radiation is expressed by a material constant called emissivity coefficient or just emissivity. This coefficient lies between 0 and 100 %. A body with ideal radiation (black body) has a coefficient of 100 %. At the same temperature, bodies with real radiation emit a lower radiation. Therefore, the emissivity coefficient is < 100%. For this reason, adjust the emissivity coefficient of the target object on the pyrometer to be able to determine the exact temperature. With the configured lower emissivity coefficient, the pyrometer automatically compensates for the lower radiation.

- Emissivity: [5] → [5 E P S] = 10...110%



For the emissivity, the pyrometer has a quick adjustment function. In the process value display the value can directly be entered by using the ▲ or ▼ button without changing to the menu. When simultaneously pressing the MODE key, the display shows the current measuring temperature while the emissivity coefficient continues to be adjusted in the background. This is an easy way to determine the emissivity when the object temperature is known. The modified values are directly adopted.



Change the emissivity only when the measuring mode “one-colour” is active.

Measuring mode one-colour mode [R O] → [R O S] = [S P E c.]

5.17 Transmission factor (one-colour mode)

Besides the emissivity correction, a pyrometer must be adjusted for the transmission properties of any supplementary lens and/or protective window screwed onto the pyrometer. Set the pyrometer for the specific transmission factor (a percentage value) which is indicated either in the product's data sheet or on the lens itself. If you are not using any auxiliary lens or protective window, set the parameter to 100.0.

- Transmission factor [S] → [S t R U] = 1000

5.18 IO-Link

This device has an IO-Link communication interface, which requires an IO-Link-capable module (IO-Link master) for operation. The IO-Link interface allows direct access to process and diagnostic data and offers the possibility to parameterize the device during operation.

The IODDs required for configuring the IO-Link device as well as detailed information on process data set-up, diagnostic functions and parameter addresses are available in the download area at www.keller-msr.de/pyrometer.



A 3-wire cable port Class A (Type A) must be used for IO-Link operation.

6 Electrical connection

⚠ ATTENTION

The pyrometer may only be installed by a skilled, qualified electrician. Do not connect the instrument while the voltage supply source is turned on. Please observe international safety regulations at all times.

- ▶ Switch to neutral and verify absence of voltage
- ▶ Connect the instrument according to the following schematic:

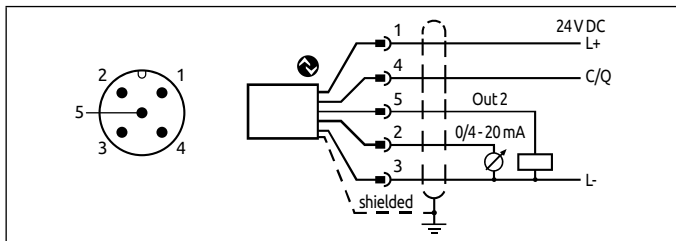

Pin 1	BN (brown)	L+ (Power supply 24V DC)
Pin 4	BK (black)	Open Collector switching output; $I_{\max} = 150 \text{ mA}$ OUT1 or IO-Link
Pin 5	GY (grey)	Open Collector switching output; $I_{\max} = 150 \text{ mA}$ OUT2
Pin 2	WH (white)	Analogue output; 0/4 ... 20mA
Pin 3	BU (blue)	L- (Shield)

! The pyrometer must be protected against high voltage and strong electro-magnetic fields. Use a shielded cable, connecting it via connector casing to the device housing.

! Use a flyback diode when switching inductive loads.

7 Shielding and Grounding

7.1 Equipotential bonding

The pyrometer housing is connected to the shielding via the cable connector!

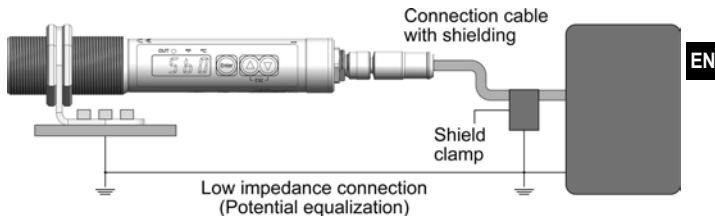

Differences in ground potentials might cause an equalising current to flow between devices through a cable shielded at both ends. In this case, be sure to install an additional equipotential bonding line.

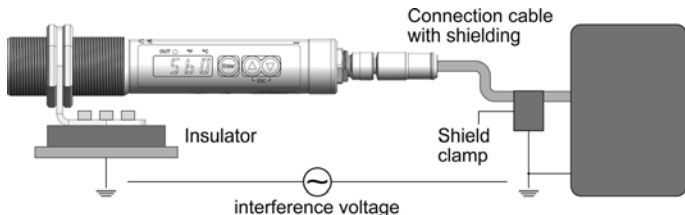

To avoid an equalising current, the pyrometer can be mounted electrically insulated. The shielding must be connected to the plant's earthing system.



If the pyrometer is installed without an insulator and without potential equalisation, the interference voltage may not exceed 32V.

8 Operating controls and display

The pyrometer PKx 6x features a 4-digit display, 3 control keys and 3 LEDs. The instrument's display panel shows the measured temperature.

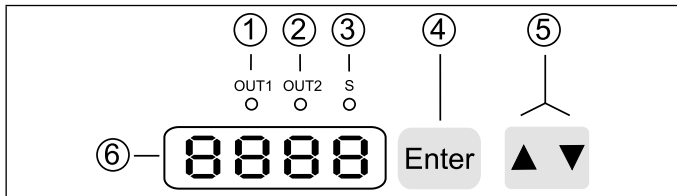

1 to 3: Indicator-LEDs

LED 1 = indicates switching output OUT1

LED 2 = indicates switching output OUT2

LED 3 = signal strength

4: Control key Enter

Select parameter and confirm setting

5: Control key up and down

Adjust configuration parameters

6: Alphanumeric display, 4-digit

- Indicates temperature value
- Indicates parameters and configuration
- Indicates overload at switching output

9 Menu

9.1 Process value display

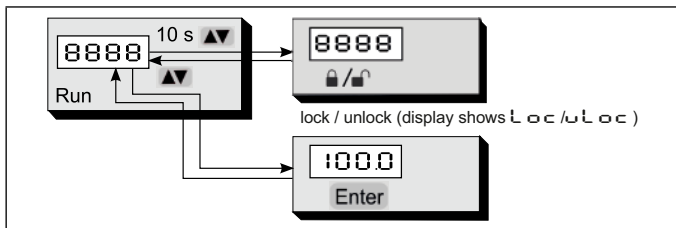

9.2 Analogue output

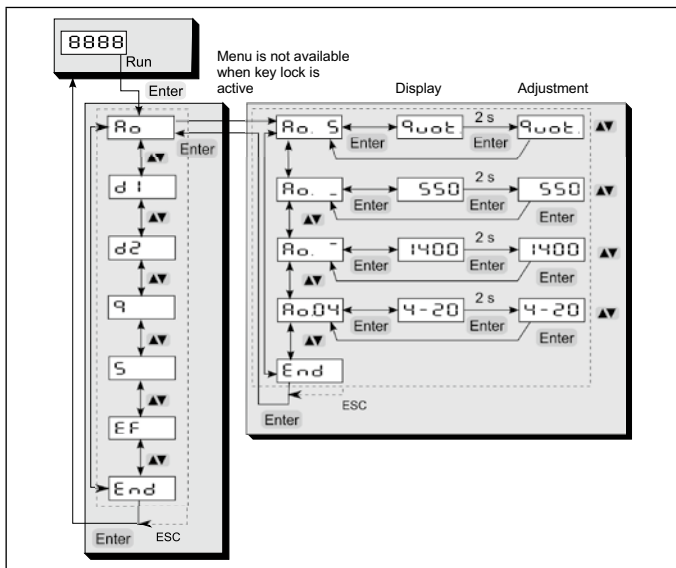

9.3 Switching threshold OUT1

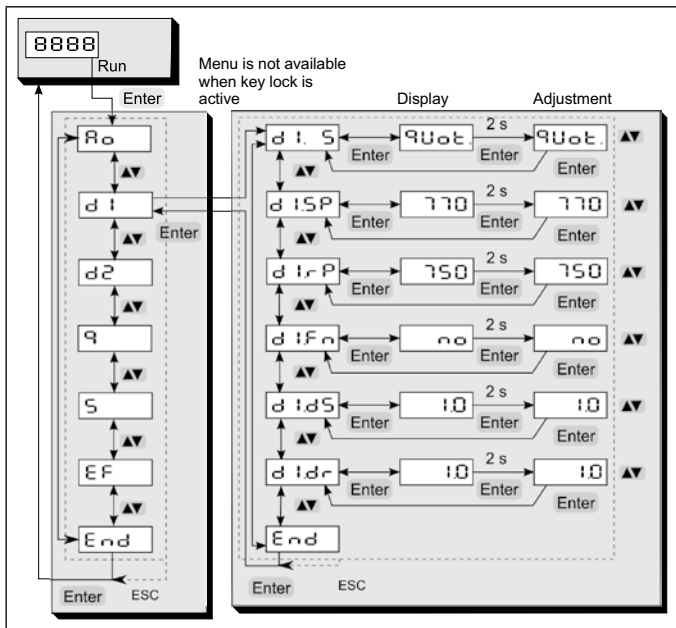

9.4 Switching threshold OUT2

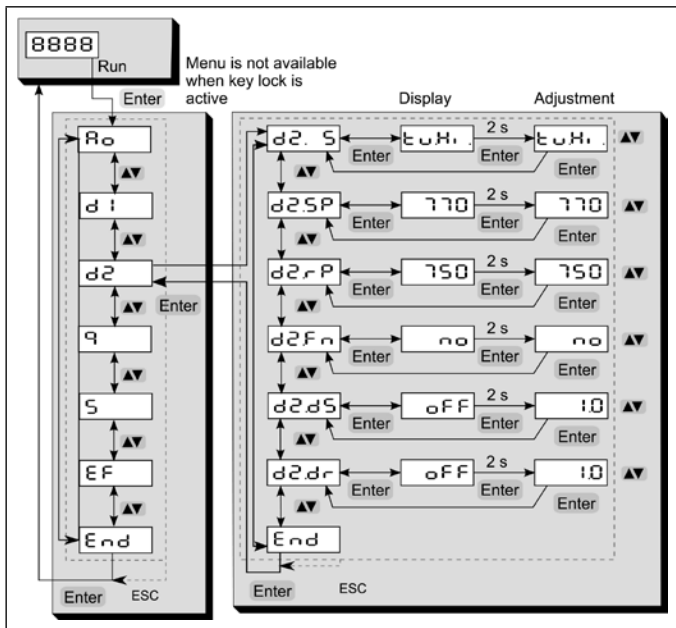

9.5 Two-colour mode

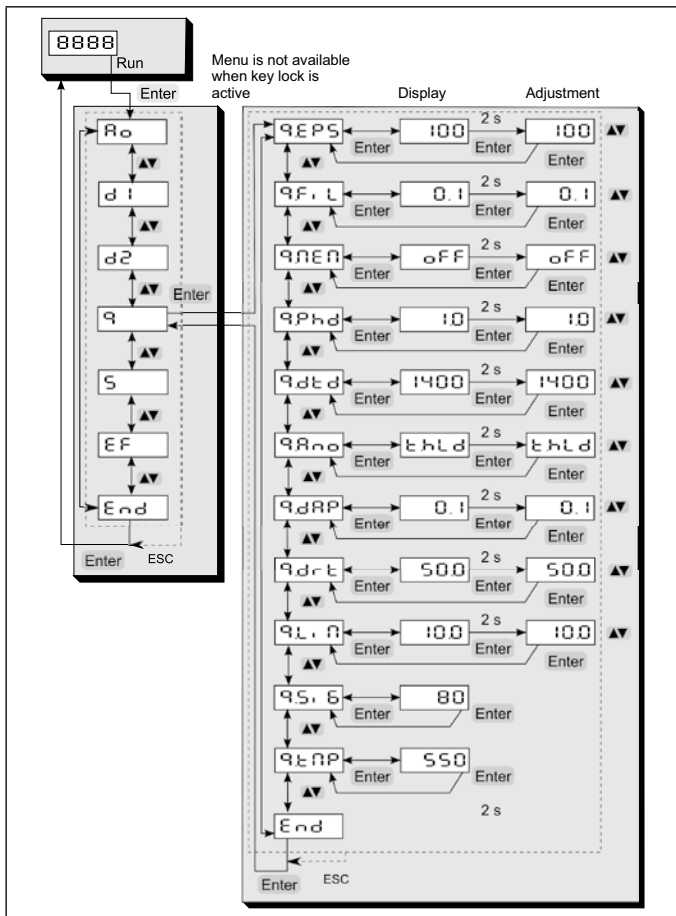

9.6 One-colour mode

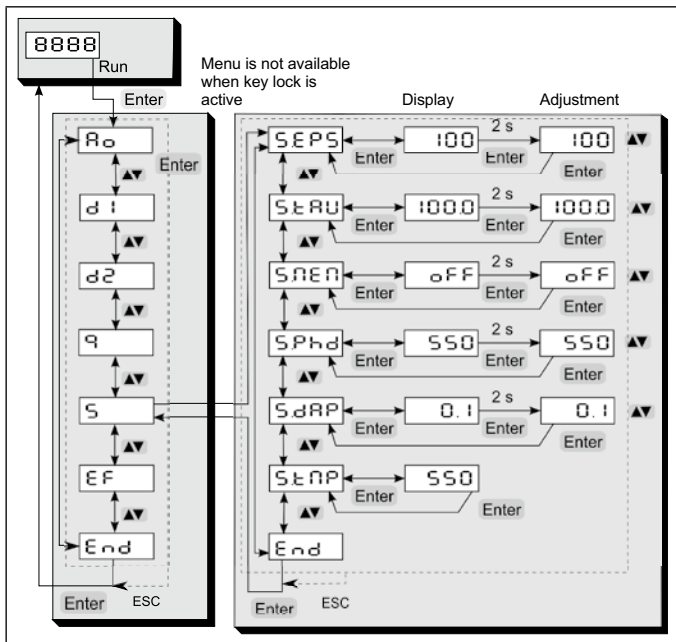

9.7 Advanced Features

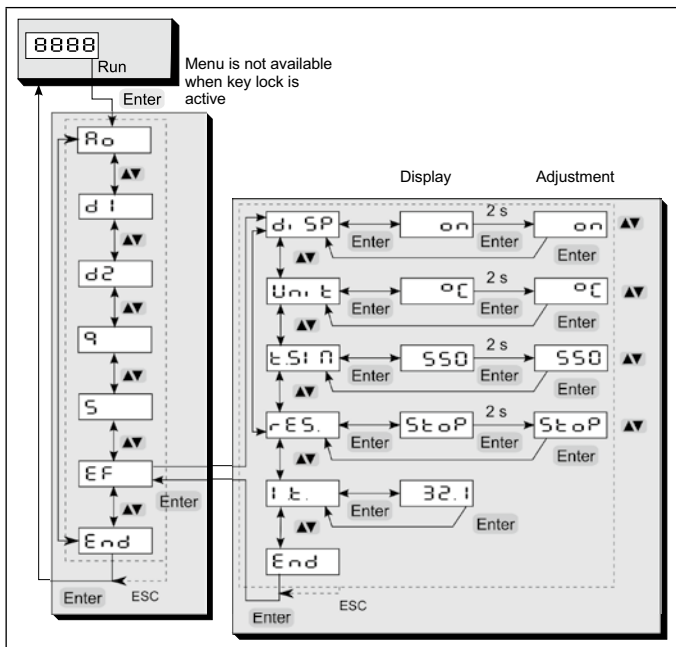

10 Menu explanation

10.1 Analogue output

Parameter	Function	Explanation
R ₀ S	Select source	9U0E . two-colour mode SPEc . one-colour mode (the selected temp. reading source will be shown on the display)
R ₀ -	Define lower limit of temp. span	Analogue start value for scaling
R ₀ '	Define upper limit of temp. span	Analogue end value for scaling
R ₀ 04	Analogue output 0/4 -20 mA	0 -20 mA scaling Analogue output 4- 20 mA scaling Analogue output
E _{nd}	End	

EN

10.2 Switching threshold OUT1

Parameter	Function	Explanation
d I S	OUT1 source	9U0E . two-colour mode SPEc . one-colour mode
d I S P	OUT1 Upper threshold	Upper threshold which activates OUT1
d I r P	OUT1 Lower threshold	Lower threshold which activates OUT1
d I F n	Output function	nc normally closed no normally open
d I d S	Upper threshold delay	Value in sec (≤ 10 sec in steps of 0.1)
d I d r	Lower threshold delay	Value in sec (≤ 10 sec in steps of 0.1)
E _{nd}	End	

10.3 Switching threshold OUT2

Parameter	Function	Explanation
d2S	OUT2 source	900E . two-colour mode SPEC . one-colour mode ESH . inner device temperature dirt . dirt alert SYNC . sync-pulse*
d2SP	OUT2 Upper threshold	Upper threshold which activates OUT2
d2rP	OUT2 Lower threshold	Lower threshold which activates OUT2
dIFn	Output function	nc normally closed no normally open
dIdS	Upper threshold delay	Value in sec (≤ 10 sec in steps of 0.1)
dIdr	Lower threshold delay	Value in sec (≤ 10 sec in steps of 0.1)
End	End	

* Only available with DTD function

10.4 Measurement acquisition (two-colour mode)

Parameter	Function	Explanation
QEPS	Ratio correction	Ratio correction 80- 120 %
QFL	Smoothing filter for min/ max memory [#]	OFF no smoothing time t_{98} 0-10 sec in 0.1 sec steps
QNE	Min/max memory	OFF off PHLD Peak hold function DTD DTD function
QPH	Hold time peak hold function*	time t_{98} in seconds (in steps of 0.1 sec)
QDT	DTD limit**	See chapter 13.4
QAN	Display mode during sampling time	$L = 0$ show lower limit of temp. range during running measurement $L = H$ Hold previous temp. reading during running measurement
QDA	Damping after min/max memory*	OFF off time t_{98} 0-999,9 sec in 0.1 sec steps
QDR	Pollution warning level	Value in % 0.1 - 100 %
QLN	switch-off threshold	Value in % 0.1 - 100 %
QSI	Q- signal intensity	Calculated signal intensity in %
QTR	Q- temperature reading	Two colour/ratio temperature reading
END	End	

[#] The filtering affects the temperature reading and the signal intensity of the two-colour mode.

* Only available with peak hold function

** Only available with DTD function

10.5 Measurement acquisition (one-colour mode)

Parameter	Function	Explanation
SEPS	Emissivity factor	Emissivity 10 - 110 %
STRU	Transmission factor	10 - 100 % (see chapter 5.17)
SNEN	Max/min memory	OFF off PHLD Peak hold function
SPhd	Hold time peak hold function *	Time sec (in 0.1 sec steps)
SDAP	Damping after min/max memory *	OFF off Time in sec (in 0.1 sec steps)
STNP	One-colour temperature reading	One-colour temperature reading
End	End	

* Menu item only if Peakhold is activated

10.6 Advanced Features

Parameter	Function	Explanation
d. SP	Process value display	On current temperature value OFF run is shown in the display
Unit	Temperature unit	°C °F
TSI	Temperature simulation	A temperature can be simulated
RES	Factory settings	Reset to factory settings
i. t.	Internal temperature	
End	End	

11 Setup

11.1 Two-colour mode

When measuring with a two-colour pyrometer, the field of view does not have to be filled entirely by the target object. There might even be particles like dust, steam and smoke in the viewing path that weaken the infrared radiation. LED 3 signals when a measurement is critical.

The signal strength is calculated for this signal.

LED 3 lights up	Measurement OK
LED 3 flashes	Signal strength below the set threshold - measurement is critical.
LED 3 off	The signal strength is too low, a measurement is not possible.

- ▶ Set the pyrometer to two-colour mode (Default):

Two-colour [R0] → [R05] = 9.00t.

- ▶ Align the pyrometer to the object to be measured

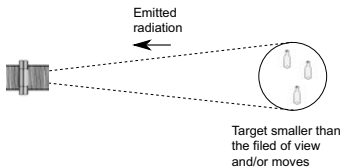
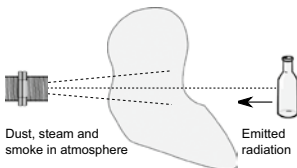
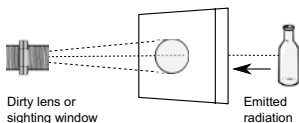
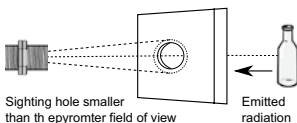

11.2 One-colour mode

- ▶ Set the pyrometer to one-colour mode:

One-colour [R 0] → [R 05] = SP E c .

- ▶ Align the pyrometer to the object to be measured

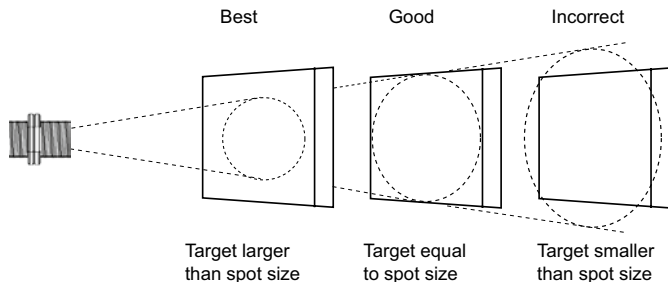

The pyrometer uses the intensity of infrared radiation for non-contact temperature measurements. It is necessary to configure the pyrometer to the respective emissivity coefficient of the measuring object to obtain exact measuring results (→ 15 Emissivity coefficient tables). An incorrectly set emissivity coefficient leads to wrong temperature readings.

Set the emissivity coefficient after connecting the supply voltage or resetting the parameters to factory settings.

- ▶ Press [▲ or ▼]
- > the value of the selected emissivity is displayed, for example [1000]
- ▶ Press [▲ or ▼] until the desired emissivity is shown
- ▶ Press [Enter] or wait for 3 seconds

The current temperature value is displayed. The pyrometer now works with this configured emissivity until it is changed again.

12 Aligning and focusing the fiber optic head

The fiber optic head has to be aligned on the target. It is important to ensure that the beam path is not obstructed. If the pyrometer has a fiber optic, it could be necessary to focus the measuring head additionally.

For that, the laser pointer is to be connected to the fiber optic and to be activated by using a button!



For focal adjustment loosen the shown socket screw (hexagon socket screw DIN 916) with a wrench (DIN 911) and shift the internal body of the tube towards the lens tube.

Due to the O-ring sealing between the internal body of the tube and the lens tube the focal adjustment must be carried out very slowly so that the air pressure in the space between lens and internal body of the tube can be equalised.

Focus the sensing head until the spot light is shown as a sharp round laser spot in the target area. In bright daylight or in an excessively lit environment it is recommendable to dim the area around the target.

12.1 Safety instructions and precautions

Laser Radiation Hazard: Laser radiation can be harmful to eye!

The laser pointer operates with a class 2 red light laser. Direct prolonged viewing of a laser beam can injure the retina. There-fore, the following safety precautions must be strictly observed, otherwise the laser may not be operated!

- Only use the laser to align and focus the pyrometer. Deactivate the laser immediately afterwards.
- Never look directly into the laser beam path.
- Do not leave the instrument unattended when the laser is activated.
- Do not point the laser beam at any person.
- During pyrometer installation and alignment, make sure to avoid the possibility of laser light reflections caused by reflective surfaces.
- All currently valid laser safety standards must be observed.

Laser Power

The laser operates at a wavelength of 630 - 670 nm (visible red light). The emitted power of the laser beam at the lens opening is max. 1.0 mW. Under normal operating conditions, the emitted radiation does not present a danger to human skin. This laser product is classified according to laser class 2, IEC 60825-1.

Laser Warning Label

The black and yellow laser warning label is affixed on the laser pointer.



13 Operating parameters

When you reset/adjust the operating parameters the instrument remains in run mode. It continues to operate, using the current parameter settings, until you have finished configuring by pressing [Enter].

13.1 Setting parameters – general information

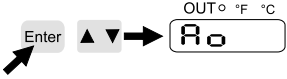
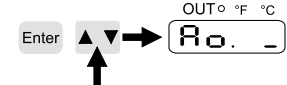
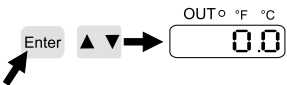
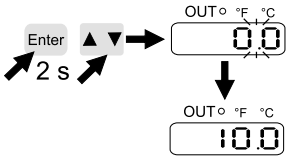
<p>1 Select parameter</p> <p>▶ Press [Enter] to access the main menu.</p>		EN
<p>2 Select output function</p> <p>Press key [▼] until the required output function or the Advanced Features is displayed.</p>		
<p>3 Show parameter value</p> <p>▶ Press [Enter]</p> <p>> Current parameter value is displayed. *</p>		
<p>* The pyrometer will display the parameter value for 30 sec. After that the display will once again indicate the measurement as a percentage.</p>		
<p>4 Change parameter value</p> <p>▶ Press ENTER for 2 seconds, > display flashes continuously</p> <p>▶ Press [▲] or [▼] to change the parameter</p> <p>Hold key [▲] or [▼].</p> <p>> Numerical values scroll through rapidly</p>		

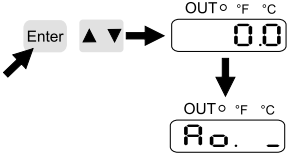
5	<p>Confirm parameter value</p> <ul style="list-style-type: none"> ▶ Press [Enter] > The display indicates the parameter. The new value has been saved and will take effect. 	
<p>Adjust additional parameters</p> <ul style="list-style-type: none"> ▶ Start again with step 2. 		
<p>Exit operating parameters layer</p> <ul style="list-style-type: none"> ▶ Wait 30 seconds <p>or</p> <ul style="list-style-type: none"> ▶ Press [▲] or [▼] to change to the parameter E_{nd}. Then press [Enter] to change to the functional menu ▶ In the functional menu press [▲] or [▼] to change to the parameter E_{nd}, then press [Enter]. 		



The instrument features a keylock. Activate/deactivate the keylock as follows:

- ▶ Press key [▲▼] simultaneously and hold them down for 10 sec.
- > The display shows Loc or uLoc for 1 second to signalize the change.



If you press both keys [▲▼] only briefly, you will exit the layer (ESC function).

13.2 Damping function

When the target object's temperature is erratic, the damping function smoothens these temperature fluctuations in order to stabilize the measuring signal. The greater the time constant [τ_{RP}], the lower the effect of these fluctuations on the yielded temperature reading.

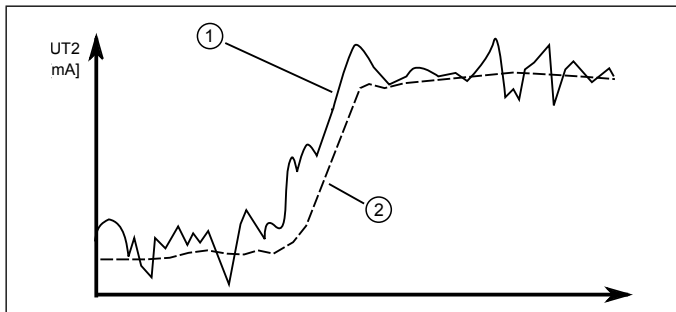

- 1: Output signal without smoothing function
- 2: Output signal with smoothing function

13.3 Peak hold function

It might often be desirable to determine the peak temperature during a defined time period, for example when the objects to be measured move past the pyrometer, resulting in temperature readings which would appear to be cyclical. In this mode, the displayed temperature reading will not drop between targeted objects. The peak temperature reading will be held for a preset time period.

The hold time [PHLD] can be set from 0.1 to 999.9 sec. The maximum temperature sampled during the defined hold time will be saved. It makes sense to choose a hold time which is approximately 1.5 times as long as the cycle of the moving targets. This avoids temperature drops. Rising temperatures are still recognised at once.

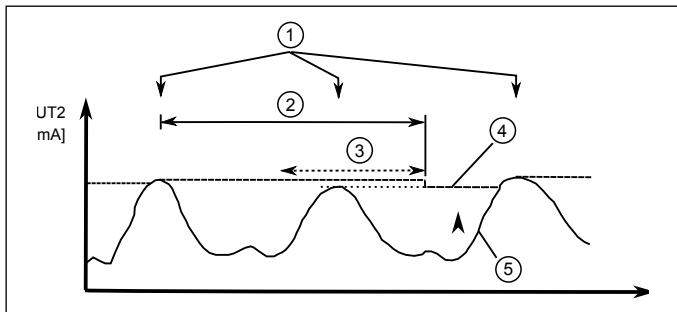

- 1: Measuring object in front of pyrometer
- 2: Hold time
- 3: Measurement time of the second internal peak value memory
- 4: Measuring readings with peak hold function
- 5: Measuring readings without peak hold function

13.4 DTD function (Discontinuous Temperature Detection)

This function serves to automatically detect the temperature during manufacturing processes with discontinuous or intermittent material flow. For example, thus can determine the temperature of bolts with variable lengths, that move acyclic along the pyrometer. A temperature threshold has to be defined for this purpose. The measurement starts when the object temperature is higher than the set threshold.

• [9] → [97E 7] = [d t d]

The measurement stops when the threshold is violated and the maximum value is available at the analogue output.



The reset point is 5 K below the parameterised threshold.

In parallel, a sync pulse is given to OUT2. OUT2 is switching when the threshold is exceeded, depending on the parameters set. If the value falls below the threshold, OUT2 returns to its previous state.

• [d 2] → [d 25] = [5 4 n c]

It can further be set which temperature is displayed or available at the output during the measurement.

- [9] → [9.8.00] = [t h L d.] During the measurement the previous reading is available at the temperature output.
- [9] → [9.8.00] = [t 0] During the measurement the temperature is set to the lower limit of the temperature range.

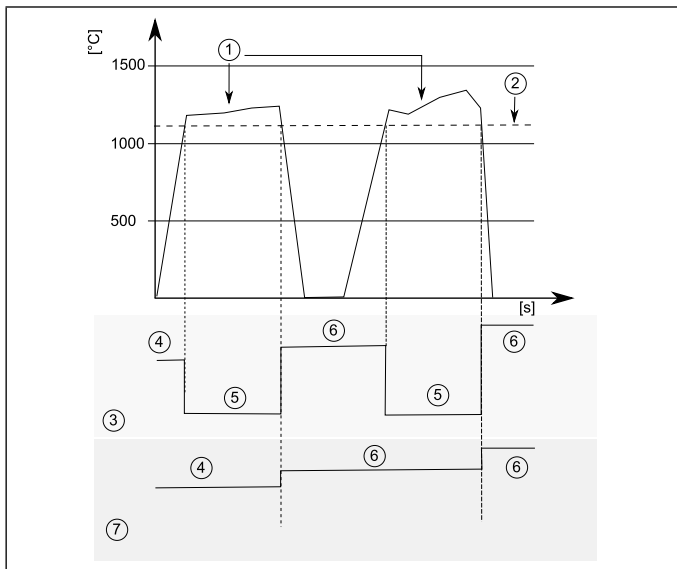

- 1: Measuring object in front of pyrometer
- 2: Limit [d t d]
- 3: Temperature output [9.8.00] = [t 0]
- 4: Previous reading
- 5: Lower limit of temperature range
- 6: New reading
- 7: Temperature output [9.8.00] = [t h L d.]

13.5 Reset all parameters to factory settings

▶ [$r \ E \ S$] select in menu advanced functions

▶ Press [ENTER]

> The display shows [STOP]

▶ Hold [ENTER] for 2 seconds

> Display flashes for 2 seconds

▶ Press [\blacktriangle]

> The display shows [$E \ H \ E \ c \ .$]

▶ Press [ENTER]

> The display shows the current temperature



After a reset to factory settings configure the emissivity coefficient [$E \ P \ S$] again (\rightarrow 10 Setup) to obtain exact measuring results.

14 Operation

After connecting the supply voltage the pyrometer will be automatically initialized and will perform a self-diagnosis. After approx. 0.5 sec the sensor is ready to operate and the instrument runs the signal processing.

The parameters are described in chapter 10 / page 25.

14.1 Ambient temperature

The maximum permissible ambient operating temperature for the pyrometer is 65 °C. If the instrument is used in ambient temperatures above 65 °C, it must be either cooled or shielded from excess radiant heat by means of a deflector plate.

14.2 Error indications

Overload output	The corresponding LED OUT 1 will flash at 4 Hz. The display shows "5 C !" at 2 Hz.
Overtemperature	Display $\square \text{E}$ alternately shows overtemperature and measurement reading at = 0.5 Hz. The corresponding LED flashes at 4 Hz when the output is switched off.
Incorrect connection of supply voltage	LED OUT 1 flashes at 2 Hz.
Supply voltage \leq approx. 16 V	LED, display, switching output and analogue output are deactivated. (When voltage \geq 16 V the device switches on and the switching outputs are activated).
Temperature below lower threshold	The display shows UL .
Temperature above upper threshold	The display shows OL .

EN

15 Theory of Non-Contact Temperature Measurements

All materials radiate thermal energy in all states of aggregation above absolute zero. This radiation is mainly caused by atomic or molecular oscillations.

This temperature radiation is only a limited sector within the total electromagnetic radiation spectrum. It extends from the visible range starting at wavelengths of approx. 0.5 μm to the infrared range with wavelengths of more than 40 μm . Radiation pyrometers detect infrared radiation for non-contact temperature measurement.

15.1 Advantages of Non-Contact Temperature Measurement

- Non-contact temperature detection means cost-effective temperature measurement because this technique only requires a single investment in an instrument without any follow-up costs for consumables such as thermocouples.
- This method enables temperature detection of moving objects - quick temperature measurements within milliseconds - for example at automatic welding processes.

- Small objects with medium and high temperatures can also be easily and accurately measured.
- When measuring materials with low specific heat, a non-contact method does not induce heat loss which would distort the temperature reading (as is the case with contact temperature probes). Non-contact temperature detection is ideal with corrosive molten materials for which the use of thermocouples is hardly feasible.
- Last but not least it is also possible to measure the temperature of voltage-carrying objects.

15.2 Measurements at Black Bodies (Cavity Radiators)

A black body or a black radiator is used to calibrate radiation pyrometers. This black body is designed in a way that its radiation does not

depend on material characteristics, but only on its temperature. A black body emits at any wavelength the maximum energy possible for the specific temperature. Real bodies do not have this ability. In other words, a black body completely absorbs the radiation without reflection or transmission losses. The spectral emissivity coefficient $\epsilon(\lambda)$ of a black body is equal to 1 or 100 %. The emissivity coefficient indicates the ratio of radiation of a real body (target) to the radiation of an ideal black body.

$$\epsilon(\lambda) = \frac{M}{M_s}$$

$\epsilon(\lambda)$: Emissivity coefficient of the object's surface (targeted spot) at wavelength λ

M : radiant energy actually emitted by a real object

M_s : radiant energy emitted by a black body (perfect radiator)

Most burning, annealing and hardening furnaces emit a radiation of nearly 1, which corresponds to the conditions of a black body if the aperture through which the measurement is made is relatively small.

15.3 Measurements of Real Radiators

Real radiation sources are characterized by the relation of the emitted radiation to the radiation of a black body with the same temperature. Measurements outside a

furnace - which applies to all other self-contained targets - always show a reading which is too low. Considerable errors can occur at targets with reflecting, polished or bright surfaces, e.g. molten steel and metal without oxide layer and ceramic materials. Exact results can only be obtained when the emissivity coefficient is correctly adjusted on the pyrometer.

The spectral emissivity coefficient of a body does not represent an exact material constant, but is also largely dependent on the surface properties (→ 16 Ways to determine emissivity).

15.4 Measurements errors

The cause of measurement errors in the use of pyrometers is often an incorrectly determined or wrong emissivity.

Another source of error is the reflected „background radiation“.

If the measurement object has a low emissivity and there are hotter objects in the surrounding area, measurement results can be affected. These objects then have to be shaded. This effect is particularly to be observed in the measurement of a colder object within a hot oven.

16 Ways to determine emissivity

Technical literature or operating manuals often contain data on the emissivity of various materials. This information should be used with caution, however. It is important to know for which temperature and which wavelength the emissivity value is applicable. Furthermore, the stated emissivity values were obtained under ideal conditions. In actual practice, the total emissivity of the target object will vary, depending on the amount of extraneous radiation transmitted through the object from the background or reflected onto the object from the foreground.

The emissivity can be determined using one of the following methods:

Contact measurements

Measure the temperature with a contact thermocouple and measure the surface temperature with a pyrometer. Adjust the emissivity coefficient on the pyrometer until both devices show the same temperature. When measuring with the thermocouple, make sure to have good thermal contact and low heat dissipation.

Using a reference emissivity coefficient

Apply matte black colour to a part of the surface to be measured. This part has an emissivity of 94 %. At first, measure the temperature of the coloured part. Then make a comparative measurement right next to the coloured part and adjust the emissivity on the pyrometer until it displays the previous measurement reading again.

16.1 Emissivity Table (One-colour mode)

Overview of the emissivities of different materials in %.

Model	PKx 6x
Wavelength λ	0.8 - 1.1 μm
Black Body	100
Aluminium, polished	15
Aluminium, blackened	25
Asbestos cement	70
Bronze, polished	3
Bronze, blackened	30
Chromium, polished	30
Iron, heavily scaled	95
Iron, rolling skin	90
Iron, liquid	30
Gold and silver	2
Graphite, blackened	90
Copper, oxidized	90
Brass, oxidized (tarnished)	70
Nickel	20
Porcelain, glazed	60
Porcelain, rough	85
Soot	95
Fireclay	50
Slag	85
Pottery, glazed	90
Bricks	90
Zinc	60

17 Maintenance

17.1 Cleaning the pyrometer lens

A false temperature reading will be given when the lens is dirty. Therefore, check the lens periodically and clean it, if necessary. Dust can be removed by simply blowing it away or by using a soft brush. A special lens cleaning cloth is ideal, but any soft, clean, lint-free cloth will be suitable. If the lens is quite dirty, use a very mild liquid detergent and rinse carefully with clear water while holding the device pointed down. Apply as little pressure as possible to avoid scratching the lens.

18 Shipping, packaging and disposal

18.1 Inspection after shipping

Unpack and inspect the entire shipment immediately upon receipt to make sure it is complete and undamaged. If the container/package shows visible signs of damage, please refuse the shipment. If this is not possible, accept the shipment on the condition that the freight carrier's delivery record is noted with the extent of the damage in order to file a claim. Should you discover a concealed loss or damage, report it to the shipper or freight carrier immediately. If the period for filing claims has expired, you will no longer be able to make any claims for compensation of damage or loss.

18.2 Packaging

The packages used are made of carefully selected, environmentally compatible materials and are thus recyclable. Please ensure that they are disposed of in an ecologically sound manner.

18.3 Disposal of the old devices



Old electrical and electronic devices frequently still contain valuable materials. These devices can be returned for disposal to the manufacturer or they must be disposed properly by the user. For the improper disposal of the device by the user, the company KELLER HCW is not responsible.

19 Accessories

Device	Type	Ident no.
Shielded cable	VK 02/L AF 1: 5 m	1043813
Shielded cable	VK 02/L AF 2: 10 m	1047718
Laser pointer	PS 01/M AF 3	1039284
Laser pointer	PS 01/P	1029357
Air purge	PS 01/A	560951
Air purge	PS 01/AAF 2	561553
Oscillating mirror	PZ 20/X AF 5	561630
Thermal insulating tube	PS 01/K	513522
Cooling jacket	PK 01/B AF 1	1067753
Bayonet coupling	PS 11/N AF 4	561585
90° Deflection mirror	PS 11/W	561955
Supplementary tube	ZA 01/Q-35	514234
Intermediate tube	ZA 01/M	513807
Intermediate tube	ZA 01/B	513596
Intermediate tube	ZA 01/Q AF 2	515528
Clamping collar with angle	PS 11/K-35 AF 2	561558
Mounting bracket	PS 11/U	561537
Flange	PS 01/N	513303
Flange	ZA 01/I	513533
Flange	ZA 01/W	514831
Flange	DN 50	515087
Tube cap	ZA 01/A	513415
Bracket	PS 11/P	1044060
Ball flange	ZA 01/D	513431
Adapter lens	PS 27/E	561620
Quarz window	PS 01/I AF 2	561487

20 General technical data

Load	max. 500 Ω
Switching output OUT1/2	Open Collector outputs 24 V, \leq 150 mA switch point [$^{\circ}$ C]/ reset point [$^{\circ}$ C], hysteresis \geq 2 K, Switch-on-/Switch-off-delay, NC/ NO
IO-Link revision	V1.1, downward compatible to V1.01
SIO mode	yes, supported
Transmission rate	COM2 (38.400 Baud)
Storage temperature	-20 - 80 $^{\circ}$ C
Permissible humidity	95 % r.H. max. (non condensing)
Power requirement	24 V DC +10 % / -20 % Ripple \leq 200 mV
Housing material	Stainless steel
Weight	approx. 0.4 kg
Connectivity	5-pin connection M12 (A coded)
Protection	IP 65 according to DIN 40050 with screwed plug
Configuration parameters	Emissivity ratio 80 - 120 % Emissivity ϵ 10 - 110 % Smoothing function t_{98} - before Max/min memory 0.1 - 10 s - after Max/min memory 0.1 - 999.9 s Peak hold function 0.1 - 999.9 s DTD function

EN

21 Device-specific technical data and field of view diagrams

PK 68 AF 1	
Temperature range	550 - 1400 °C
Sensor	Double Si
Spectral sensitivity	0.95 / 1.05 μm
Focus distance	1500 mm
Target spot diameter	21 mm
Analogue output	0(4) - 20 mA linear, switchable, scalable (≥ 50 K)
Resolution current output	0.2 K + 0.03 % of selected range
Resolution temp. reading	1 K
Response time t_{90}	≤ 10 ms (for $T > 650$ °C)
Repeatability	2 K
Measurement uncertainty	1.0 % of temp. reading [°C]
Temperature coefficient	0.05 %/K of temp. reading / K (deviation to $T_u = 23$ °C)
Ambient temperature	0 - 65 °C
Current consumption	≤ 50 mA at 24 V DC without load current
Dimensions	M30 x 210 mm (without plug)

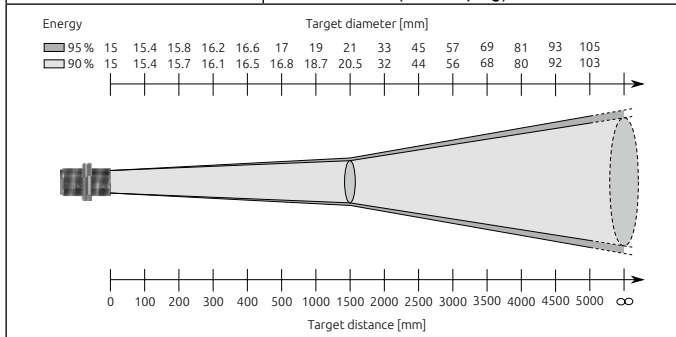

PKF 66 AF 1	
Temperature range	700 - 1800 °C
Sensor	Double Si
Spectral sensitivity	0.95 / 1.05 µm
Focus distance	200 - ∞ mm
Target spot diameter	190 : 1
Analogue output	0(4) - 20 mA linear, switchable, scalable (≥ 50 K)
Resolution current output	0.2 K + 0.03 % of selected range
Resolution temp. reading	1 K
Response time t_{90}	≤ 10 ms (for T > 800 °C)
Repeatability	2 K
Measurement uncertainty	1.0 % of temp. reading [°C] plus 3.0 K
Temperature coefficient	0.05 %/K of temp. reading / K (deviation to $T_u = 23$ °C)
Ambient temperature	0 - 65 °C
Current consumption	≤ 50 mA at 24 V DC without load current
Dimensions	M30 x 200 mm (without plug)

EN

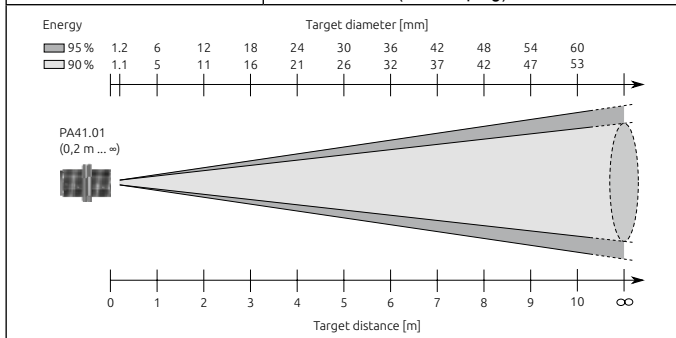

PKF 66 AF 2	
Temperature range	700 - 1800 °C
Sensor	Double Si
Spectral sensitivity	0.95 / 1.05 μm
Focus distance	1080 mm
Target spot diameter	6.9 mm
Analogue output	0(4) - 20 mA linear, switchable, scalable (≥ 50 K)
Resolution current output	0.2 K + 0.03 % of selected range
Resolution temp. reading	1 K
Response time t_{90}	≤ 10 ms (for T > 800 °C)
Repeatability	2 K
Measurement uncertainty	1.0 % of temp. reading [°C] plus 3.0 K
Temperature coefficient	0.05 %/K of temp. reading / K (deviation to $T_u = 23$ °C)
Ambient temperature	0 - 65 °C
Current consumption	≤ 50 mA at 24 V DC without load current
Dimensions	M30 x 200 mm (without plug)

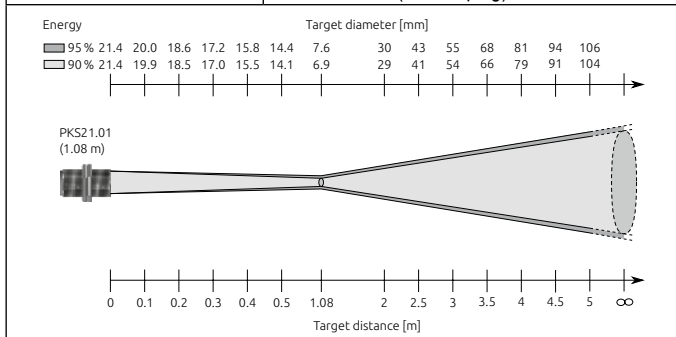

PKF 66 AF 3	
Temperature range	700 - 1800 °C
Sensor	Double Si
Spectral sensitivity	0.95 / 1.05 μm
Focus distance	120 - ∞ mm
Target spot diameter	100 : 1
Analogue output	0(4) - 20 mA linear, switchable, scalable (≥ 50 K)
Resolution current output	0.2 K + 0.03 % of selected range
Resolution temp. reading	1 K
Response time t_{90}	≤ 10 ms (for T > 800 °C)
Repeatability	2 K
Measurement uncertainty	1.0 % of temp. reading [°C] plus 3.0 K
Temperature coefficient	0.05 %/K of temp. reading / K (deviation to $T_u = 23$ °C)
Ambient temperature	0 - 65 °C
Current consumption	≤ 50 mA at 24 V DC without load current
Dimensions	M30 x 200 mm (without plug)

Energy	Target diameter [mm]										
95 %	1.2	11	21	32	42	53	63	74	84	95	105
90 %	1.2	10	20	30	40	50	60	70	80	90	100

PA41.05
(0.12 m ... ∞)

Target distance [m]

PKF 66 AF 4	
Temperature range	700 - 1800 °C
Sensor	Double Si
Spectral sensitivity	0.95 / 1.05 µm
Focus distance	33 - 45 mm
Target spot diameter	50 : 1
Analogue output	0(4) - 20 mA linear, switchable, scalable (≥ 50 K)
Resolution current output	0.2 K + 0.03 % of selected range
Resolution temp. reading	1 K
Response time t_{90}	≤ 10 ms (for T > 800 °C)
Repeatability	2 K
Measurement uncertainty	1.0 % of temp. reading [°C] plus 3.0 K
Temperature coefficient	0.05 %/K of temp. reading / K (deviation to $T_u = 23$ °C)
Ambient temperature	0 - 65 °C
Current consumption	≤ 50 mA at 24 V DC without load current
Dimensions	M30 x 200 mm (without plug)

Energy

Target diameter [mm]

95 %

0.66 0.68 0.7 0.72 0.74 0.76 0.78 0.8 0.82 0.84 0.86 0.88 0.9

PZ41.18
(33 - 45 mm)

33 34 35 36 37 38 39 40 41 42 43 44 45

Target distance [mm]

PKF 66 AF 5	
Temperature range	700 - 1800 °C
Sensor	Double Si
Spectral sensitivity	0.95 / 1.05 μm
Focus distance	1800 mm
Target spot diameter	8 mm
Analogue output	0(4) - 20 mA linear, switchable, scalable (≥ 50 K)
Resolution current output	0.2 K + 0.03 % of selected range
Resolution temp. reading	1 K
Response time t_{90}	≤ 10 ms (for T > 800 °C)
Repeatability	2 K
Measurement uncertainty	1.0 % of temp. reading [°C] plus 3.0 K
Temperature coefficient	0.05 %/K of temp. reading / K (deviation to $T_u = 23$ °C)
Ambient temperature	0 - 65 °C
Current consumption	≤ 50 mA at 24 V DC without load current
Dimensions	M30 x 200 mm (without plug)

Energy	Target diameter [mm]															
95%	9.2	9.4	9.6	9.8	10	10.2	11.1	12.1	13	19	24	30	35	41	46	
90%	9.2	9.3	9.4	9.5	9.7	9.8	10.4	10.9	11.5	17	22	27	32	37	43	

PA 41.03
(2.0 m)

Target distance [m]

PKF 67 AF 5	
Temperature range	600 - 1400 °C
Sensor	Double Si
Spectral sensitivity	0.95 / 1.05 µm
Focus distance	1800 mm
Target spot diameter	16 mm
Analogue output	0(4) - 20 mA linear, switchable, scalable (≥ 50 K)
Resolution current output	0.2 K + 0.03 % of selected range
Resolution temp. reading	1 K
Response time t_{90}	≤ 10 ms (for T > 700 °C)
Repeatability	2 K
Measurement uncertainty	1.0 % of temp. reading [°C] plus 3.0 K
Temperature coefficient	0.05 %/K of temp. reading / K (deviation to $T_u = 23$ °C)
Ambient temperature	0 - 65 °C
Current consumption	≤ 50 mA at 24 V DC without load current
Dimensions	M30 x 200 mm (without plug)

Energy	Target diameter [mm]															
95%	23.4	23	22.7	22.3	21.9	21.5	19.7	16.7	32.3	43.4	54.6	65.7	76.9	88		
90%	23.4	23	22.6	22.2	21.8	21.3	19.3	16	31.3	42.3	53.2	64.2	75.1	86		

PA41.03
(1.8 m)

Target distance [m]

PKL 63 AF 1	
Temperature range	650 - 1600 °C
Sensor	Double Si
Spectral sensitivity	0.95 / 1.05 µm
Focus distance	210 mm
Target spot diameter	4.1 x 0.6 mm
Analogue output	0(4) - 20 mA linear, switchable, scalable (≥ 50 K)
Resolution current output	0.2 K + 0.03 % of selected range
Resolution temp. reading	1 K
Response time t_{90}	≤ 10 ms (for T > 750 °C)
Repeatability	3 K
Measurement uncertainty	1.5 % of temp. reading [°C]
Temperature coefficient	0.05 %/K of temp. reading / K (deviation to $T_u = 23$ °C)
Ambient temperature	0 - 65 °C in sum of load currents Do1 and Do2 ≤ 150 mA, otherwise 0 - 60 °C
Current consumption	≤ 75 mA at 24 V DC without load current
Dimensions	M30 x 235 mm (without plug)

EN

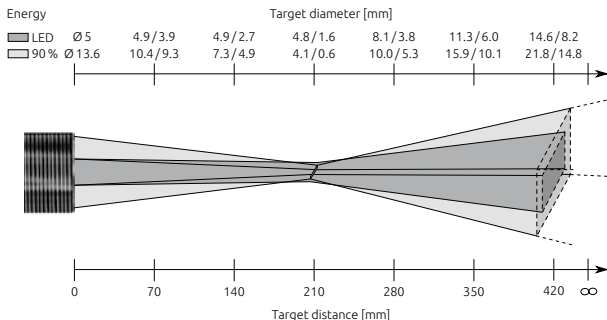

PKL 63 AF 2	
Temperature range	650 - 1600 °C
Sensor	Double Si
Spectral sensitivity	0.95 / 1.05 µm
Focus distance	1000 mm
Target spot diameter	18.5 x 2.7 mm
Analogue output	0(4) - 20 mA linear, switchable, scalable (≥ 50 K)
Resolution current output	0.2 K + 0.03 % of selected range
Resolution temp. reading	1 K
Response time t_{90}	≤ 10 ms (for T > 750 °C)
Repeatability	3 K
Measurement uncertainty	1.5 % of temp. reading [°C]
Temperature coefficient	0.05 %/K of temp. reading / K (deviation to $T_u = 23$ °C)
Ambient temperature	0 - 65 °C in sum of load currents Do1 and Do2 ≤ 150 mA, otherwise 0 - 60 °C
Current consumption	≤ 75 mA at 24 V DC without load current
Dimensions	M30 x 235 mm (without plug)

Energy	Target diameter [mm]						
LED Ø5	13.5/6.3	22.0/7.5	35.5/13.8	49.0/20.0	62.5/26.2	76.0/32.5	
90% Ø13.6	16.1/8.2	18.5/2.7	34.6/10.9	50.6/19.0	66.6/27.2	82.7/35.3	

Target distance [mm]

PKL 68 AF 1	
Temperature range	650 - 1600 °C
Sensor	Double Si
Spectral sensitivity	0.95 / 1.05 μm
Focus distance	210 mm
Target spot diameter	1.2 mm
Analogue output	0(4) - 20 mA linear, switchable, scalable (≥ 50 K)
Resolution current output	0.2 K + 0.03 % of selected range
Resolution temp. reading	1 K
Response time t_{90}	≤ 10 ms (for T > 750 °C)
Repeatability	2 K
Measurement uncertainty	1.0 % of temp. reading [°C]
Temperature coefficient	0.05 %/K of temp. reading / K (deviation to $T_u = 23$ °C)
Ambient temperature	0 - 65 °C in sum of load currents Do1 and Do2 ≤ 150 mA, otherwise 0 - 60 °C
Current consumption	≤ 75 mA at 24 V DC without load current
Dimensions	M30 x 235 mm (without plug)

Energy	Target diameter [mm]														
LED	5	4.5	4.0	3.6	3.1	2.6	2.1	3.3	4.5	5.7	6.8	8	9.2	10.4	11.5
95 %	18.2	15.4	12.5	9.7	6.9	4	1.2	4.5	7.7	10.9	14.1	17.4	20.6	23.8	27.0

Target distance [mm]															
0	35	70	105	140	175	210	245	280	315	350	385	420	455	490	∞

PKL 68 AF 2	
Temperature range	650 - 1600 °C
Sensor	Double Si
Spectral sensitivity	0.95 / 1.05 µm
Focus distance	1000 mm
Target spot diameter	5.6 mm
Analogue output	0(4) - 20 mA linear, switchable, scalable (≥ 50 K)
Resolution current output	0.2 K + 0.03 % of selected range
Resolution temp. reading	1 K
Response time t_{90}	≤ 10 ms (for $T > 750$ °C)
Repeatability	2 K
Measurement uncertainty	1.0 % of temp. reading [°C]
Temperature coefficient	0.05 %/K of temp. reading / K (deviation to $T_u = 23$ °C)
Ambient temperature	0 - 65 °C in sum of load currents Do1 and Do2 ≤ 150 mA, otherwise 0 - 60 °C
Current consumption	≤ 75 mA at 24 V DC without load current
Dimensions	M30 x 235 mm (without plug)

Energy	Target diameter [mm]															
LED	5	6	7	8	9	10	13	16	19	22	25	28	31	34	37	
95 %	18.2	15.7	13.2	10.6	8.1	5.6	10.4	15.1	19.9	24.6	29.4	34.2	38.9	43.7	48.4	

Target distance [mm]

22 Factory settings

	Parameter	Factory settings					User settings
		PK 68 AF 1	PKF 66 AF 1-5	PKF 67 AF 5	PKL 63 AF 1/2	PKL 68 AF 1/2	
Ro	Ro S	quot.	quot.	quot.	quot.	quot.	
	Ro -	550 °C	700 °C	700 °C	650 °C	650 °C	
	Ro -	1400 °C	1800 °C	1800 °C	1600 °C	1600 °C	
	RoD4	4-20mA	4-20mA	4-20mA	4-20mA	4-20mA	
di	di S	quot.	quot.	quot.	quot.	quot.	
	diSP	770 °C	975 °C	980 °C	890 °C	890 °C	
	di rP	750 °C	950 °C	950 °C	870 °C	870 °C	
	di FN	no	no	no	no	no	
	di dS	oFF	oFF	oFF	oFF	oFF	
	di dr	oFF	oFF	oFF	oFF	oFF	
d2	d2 S	tu.Hi.	tu.Hi.	tu.Hi.	tu.Hi.	tu.Hi.	
	d2 FN	no	no	no	no	no	
	d2 dS	oFF	oFF	oFF	oFF	oFF	
	d2 dr	oFF	oFF	oFF	oFF	oFF	
q	qEPS	100	100	100	100	100	
	qFL	oFF	oFF	oFF	oFF	oFF	
	qNEN	oFF	oFF	oFF	oFF	oFF	
	qPhd	0.1	0.1	0.1	0.1	0.1	
	qdt d	550	700	550	650	650	
	qRno	t.hld.	t.hld.	t.hld.	t.hld.	t.hld.	
	qdRP	0.0	0.0	0.0	0.0	0.0	
	qdr t	50.0	50.0	50.0	50.0	50.0	
qL. n	10.0	10.0	10.0	10.0	10.0		

EN

	Parameter	Factory settings					User settings
		PK 68 AF 1	PKF 66 AF 1-5	PKF 67 AF 5	PKL 63 AF 1/2	PKL 68 AF 1/2	
S	SEPS	100	100	100	100	100	
	SEAU	100.0	100.0	100.0	100.0	100.0	
	SEEN	oFF	oFF	oFF	oFF	oFF	
	SPhd	0.1	0.1	0.1	0.1	0.1	
	SdRP	0.0	0.0	0.0	0.0	0.0	
EF	d. SP	on	on	on	on	on	
	Unit	°C	°C	°C	°C	°C	
	ES. n	550	700	600	650	650	
	r ES.	Stop	Stop	Stop	Stop	Stop	

More information at www.keller.de/its

23 Copyright

The device software contains portions of the avr-libc library.

Portions of avr-libc are Copyright (c) 1999-2007

Keith Gudger,
Bjoern Haase,
Steinar Haugen,
Peter Jansen,
Reinhard Jessich,
Magnus Johansson,
Artur Lipowski,
Marek Michalkiewicz,

Colin O'Flynn,
Bob Paddock,
Reiner Patommel,
Michael Rickman,
Theodore A. Roth,
Juergen Schilling,
Philip Soeberg,
Anatoly Sokolov,

Nils Kristian Strom,
Michael Stumpf,
Stefan Swanepoel,
Eric B. Weddington,
Joerg Wunsch,
Dmitry Xmelkov,
The Regents of the
University of California.

EN

All rights reserved.

Redistribution and use in source and binary forms, with or without modification, are permitted provided that the following conditions are met:

- * Redistributions of source code must retain the above copyright notice, this list of conditions and the following disclaimer.
- * Redistributions in binary form must reproduce the above copyright notice, this list of conditions and the following disclaimer in the documentation and/or other materials provided with the distribution.
- * Neither the name of the copyright holders nor the names of contributors may be used to endorse or promote products derived from this software without specific prior written permission.

THIS SOFTWARE IS PROVIDED BY THE COPYRIGHT HOLDERS AND CONTRIBUTORS „AS IS“ AND ANY EXPRESS OR IMPLIED WARRANTIES, INCLUDING, BUT NOT LIMITED TO, THE IMPLIED WARRANTIES OF MERCHANTABILITY AND FITNESS FOR A PARTICULAR PURPOSE ARE DISCLAIMED. IN NO EVENT SHALL THE COPYRIGHT OWNER OR CONTRIBUTORS BE LIABLE FOR ANY DIRECT, INDIRECT, INCIDENTAL, SPECIAL, EXEMPLARY, OR CONSEQUENTIAL DAMAGES (INCLUDING, BUT NOT LIMITED TO, PROCUREMENT OF SUBSTITUTE GOODS OR SERVICES; LOSS OF USE, DATA, OR PROFITS; OR BUSINESS INTERRUPTION) HOWEVER CAUSED AND ON ANY THEORY OF LIABILITY, WHETHER IN CONTRACT, STRICT LIABILITY, OR TORT (INCLUDING NEGLIGENCE OR OTHERWISE) ARISING IN ANY WAY OUT OF THE USE OF THIS SOFTWARE, EVEN IF ADVISED OF THE POSSIBILITY OF SUCH DAMAGE.

Copyright prohibits the reproduction or distribution of this instruction manual, including text, photographs or images contained herein, in whole or in part, for any purpose whatsoever, without prior consent of the author. This applies to any form of mechanical or electronic reproduction as well as to electronic transmission in any form through any medium.

Please note:

Unless otherwise stated in this instruction manual, the instruments described herein are subject to change without prior notice, particularly modifications for the sake of technological advancement.

© 2017 KELLER HCW GmbH
Carl-Keller-Straße 2-10
D-49479 Ibbenbüren-Laggenbeck
Germany
www.keller.de/its

