

IO-Link



Smart pyrometer CellaTemp® PX

for precise optical temperature measurement
 from 0 °C to + 3000 °C

N^o1 in terms of
 ACCURACY
 RELIABILITY
 INNOVATION

Range of models

Compact pyrometer



Pyrometer with fibre optic cable and optical head



Single-colour pyrometer			
Type	Temperature range	Application	Mess-feld
PX 10	0 - 1000 °C	nonmetals	○
PX 13	500 - 1600 °C	flame heating	○
PX 15	300 - 1300 °C	glass surfaces	○
	500 - 2500 °C		
PX 17	400 - 2000 °C	hot CO ₂ containing gases	○
PX 18	500 - 2500 °C	hot CO containing gases	○
PX 20	210 - 2000 °C	metals, ceramics, molten glass	○
	350 - 2500 °C		
PX 28	75 - 650 °C	aluminium; bright, shiny metal surfaces; laser applications	○
PX 29	150 - 800 °C	aluminium; bright, shiny metal surfaces, laser applications, PVD coating process	○
	180 - 1200 °C		
	250 - 2000 °C		
PX 30	500 - 2500 °C	metals, ceramics, high temperatures	○
PX 35	600 - 3000 °C	precise measurement of metals, semiconductors	○

Single-colour pyrometer		
Type	Temperature range	Application
PX 21	250 - 2000 °C	metals, ceramics, molten glass
PX 31	550 - 2500 °C	metals, ceramics, high temperatures
PX 36	650 - 3000 °C	precise measurement of metals, semiconductors

Two-colour pyrometer			
Type	Temperature range	Application	Mess-feld
PX 40	500 - 1400 °C	Metals, cement, lime, graphite, glass gobs, crystal pulling	○
	650 - 1700 °C		○
	750 - 2400 °C		○
	850 - 3000 °C		○
PX 43	600 - 1400 °C	wires, rods, heating coils, filaments	□
	650 - 1700 °C		□
	750 - 2400 °C		□
	850 - 3000 °C		□
PX 44	750 - 3000 °C	silicon, silicon carbide	○
PX 45	900 - 3200 °C	Graphite production, Crystal growing	○
PX 47	700 - 1700 °C	sooty flames	○
PX 50	500 - 1400 °C	metals at low temperatures	○
PX 60	300 - 800 °C	metals at very low temperatures	○
	400 - 1000 °C		
PX 64	500 - 1400 °C	CVD coating process	○

Two-colour pyrometer		
Type	Temperature range	Application
PX 41	700 - 1800 °C	metals, cement, lime, graphite, glass gobs, crystal pulling
	800 - 2400 °C	
	900 - 3000 °C	
	900 - 3000 °C	

Smart pyrometer CellaTemp® PX

Special Features

- Wide measuring ranges with high resolution
- Modular design: Electronics and optionally up to 5 optics
- Focusable optics
- 3 target sighting options: through-the-lens, colour video camera or laser spot light
- Compact models and fibre optic models
- Single-colour and two-colour pyrometers
- 1 Analogue output, 2 switching outputs
- Source freely configurable
- Parameters and functions adjustable via control keys
- Modern IO-Link interface
- SCM function for dirty window monitoring (two-colour pyrometer)
- ATD function (automatic temperature detection)

CellaTemp® PX Series

The CellaTemp® PX Pyromter Series is based on a modular concept consisting of the following components: optics, sensor and signal processing, data output and target sighting.

The **optical system (1)** comprises one of five available objective lenses. Select the one most suitable, depending on the required target size and measuring distance. The pyrometer is infinitely adjustable to ensure superior precision across a wide focusing range.

The **aperture (2)** determines the shape of the measurement area. As a standard, the pyrometer features a circular measurement spot. As an option, the two-colour pyrometer models can be equipped with a rectangular measurement area.

A **sensor (3)** detects the IR radiation emitted by an object's surface. It is based on the latest DC technology and does not involve any moving parts. Depending on the specific model, CellaTemp® PX pyrometers are available either in a single-colour version (single wavelength detector) or in a two-colour version (dual wavelength detector).

Special **signal processing (4)** combined with high-resolution analogue-to-digital conversion in the CellaTemp® PX enables a wide measuring span. The temperature resolution remains uniformly high across the entire measuring range.

For **measurement data output (5)**, CellaTemp® PX features 1 analogue output, two switching output and an IO-Link network interface based on the latest technology.

Three **target sighting (6)** systems are available to facilitate focusing, alignment and indication of spot size: through-the-lens sighting, laser spot light or an integrated video camera.



Analogue outputs

CellaTemp® PX features one analogue output. The user can configure the scaling of the output within the basic measuring range ($\Delta > 50$ K).

Switching outputs

CellaTemp® PX's two switching outputs provide a variety of configuration possibilities.

- The outputs function as a normally open or normally closed contacts and window function.
- This results in different application possibilities.
- Monitor compliance with configured limit values or temperature ranges.
- Trigger a status indicator.
- Synchronize data communication to the PLC when using the ATD function.

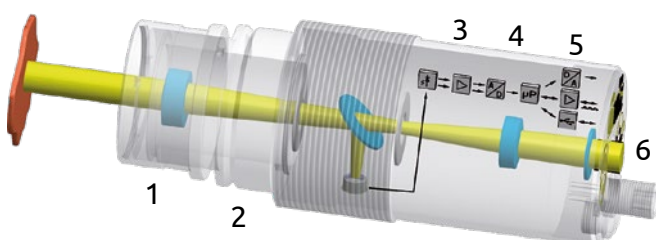

IO-Link Interface

All devices of the CellaTemp® PX series are equipped with the new IO-Link communication interface according to IEC 61131-9.

Advantages of IO-Link interface

- Standardized manufacturer and fieldbus independent interface
- Cost-effective and simple point-to-point connection with standard cable
- Low wiring costs
- Simple commissioning
- Interference-free data transmission
- Automatic parameterization with central data backup
- Full transparency down to the lowest field level
- Systematic diagnostic concepts
- Device exchange by plug and play

Optics

A pyrometer is an optical means of measuring temperature. The quality of the optics greatly influences the accuracy of the measurement. The „size of source effect“ is a factor which affects the uncertainty of the measurement. Light scattered into the optical path will result in false temperature data. When the target size or the distance to the target change, as shown in the chart, the temperature reading will change as well, depending on the quality of the optical system.

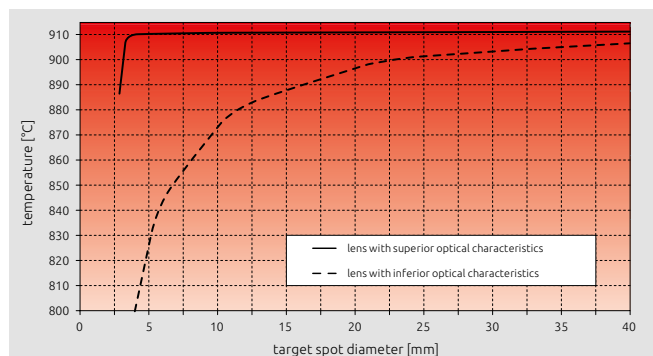

Influence of the size of the measured object on the temperature display with good and bad error correction of the optics of the pyrometer.

CellaTemp® PX pyrometers feature an optical system which is optimized for the visible and infrared range. The superior glass lens features an antireflective coating. In addition, the patented optics and apertures are mechanically designed to minimize sensitivity to light scattered into the sight path.

Due to its superior imaging properties, the high-precision lens provides consistently high optical resolution across the entire focusing range and a very small „size of source effect“. This ensures a constant high measuring accuracy independent of the size of the object and the measuring distance.

Supplementary lenses

The CellaTemp® PX can capture target spots as small as Ø 0.3 mm when an additional lens is mounted.

The pyrometer models can be combined with 4 supplementary lenses in a variety of ways, enabling additional optical resolutions for maximum versatility.



Dirty window monitor

Two-colour pyrometers feature SCM (Smart Contamination Monitoring), a function which indicates when the pyrometer lens or the protective quartz window are dirty.

The pyrometer identifies when the emitted IR energy does not completely reach the sensor due to obstructions in the line of sight or dirt buildup in the furnace port hole. The user can adjust the sensitivity of this function to a tolerated amount of signal attenuation.

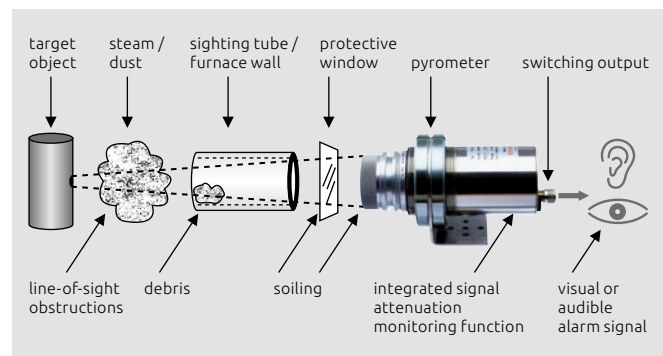

Indication of field-of-view obstruction

IO-Link Interface

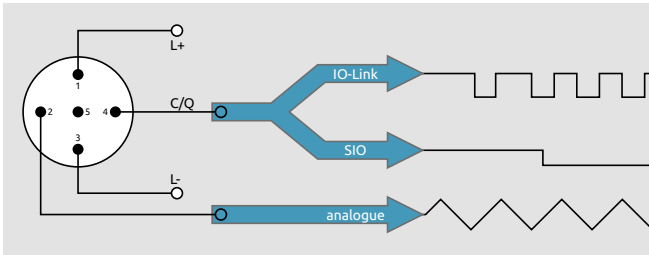

Open, system and company independent communication interface

- Internationally approved standard according to IEC 61131-9
- IO-Link consortium with all leading manufacturers of control systems
- Uniform system description of communication and device properties in the IO-Link device description file
- Certified IO-Link hardware components

Easy project planning and integration

- Can be integrated in all common field bus and automation systems
- Fast project planning and easy system documentation
- Any combination of analogue and IO-Link device in one system control system
- Downward compatible – IO-Link devices can also be operated in standard mode (SIO) as conventional sensors with switching or analogue output
- Existing wiring can continue to be used.

Simple, fast and safe installation and maintenance

- Simple point-to-point connection – low wiring time
- Uniform and „correct“ wiring by standard cable with M12 plug (plug & play)
- Easy and accurate replacement of sensors
 - Avoidance of incorrect exchange thanks to clear device identification in the vendor and device ID
 - Avoidance of incorrect settings, as parameters are stored in the master and transferred automatically on device exchange
- Condition-oriented maintenance and targeted service
- Minimum effort for troubleshooting
- Modern, manufacturer-independent tools for commissioning
- Minimum variety of types and stock-keeping

High operational safety

- Tamper-proof, as incorrect settings by the operator can be excluded
- Immediate, central fault diagnosis (wire breakage, short circuit etc.)
- Retrieval of diagnostic data for preventive maintenance and repair and therefore reduced risk of failure

Simple parameterisation

- Central parameterisation and storage of configuration data
- Dynamic parameterisation during operation for adaptive system control during recipe, material or tool changes reduces downtimes and increases flexibility and production diversity
- Automatic sensor parameterisation, plug and play on device exchange
- Simple duplication of parameters

Safe and continuous digital communication

- Process data, diagnostic data, device information and configuration parameters
- EMC-technically interference-free transmission of measured values with 2 V signal level and protection by checksum
- Continuous communication from the lowest field level up to the ERP system
- One sensor for several measured values and switching points
- Worldwide remote maintenance and teleservice down to the lowest field level

Cost saving

- Reduced installation and cabling costs
- Saving of analogue input cards by using standardized fieldbus switching groups

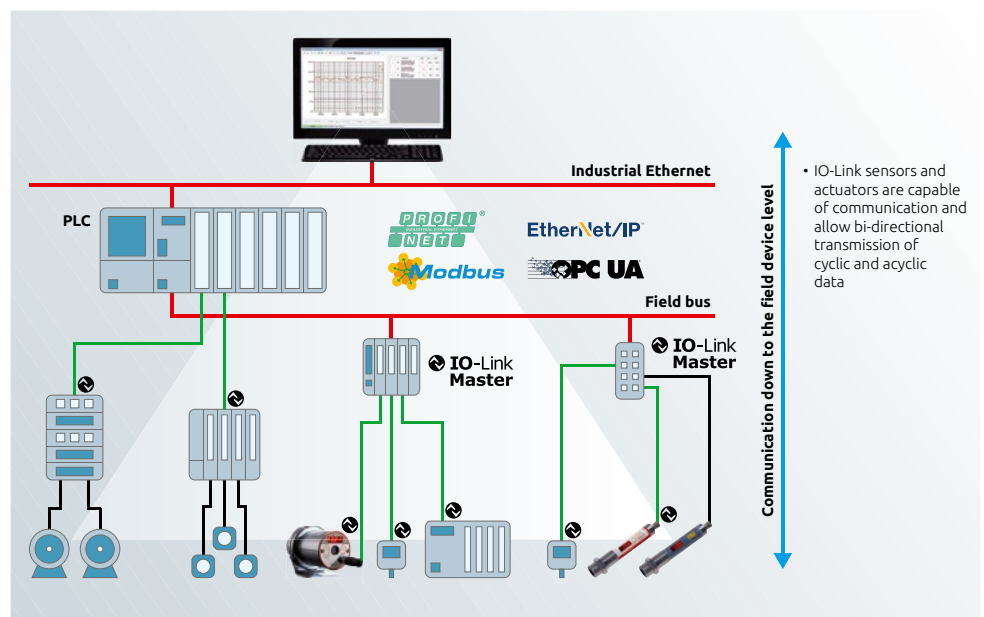

Sighting options for compact models



Through-the-lens

The CellaTemp® PX compact models can be supplied with through-the-lens, parallax-free sighting. The wide field of view makes it easy to focus on the target object. The ocular features a widened interpupillary distance, making it suitable for users who wear glasses or a helmet.



The circle in the viewfinder indicates the exact position and size of the measured target spot. If the target is especially bright, the polarizing filter PA 20/P can be mounted on the lens to protect the user's eye. For devices with a measuring range over 2000 °C, the filter is included as standard.



Laser spot light

The third sighting option available for CellaTemp® PX is an integrated laser spot light. The laser dot marks the center of the target spot and is well visible even from a distance of up to 10 m. The laser is activated either

directly by push-button or remote by means of an external switch or via interface.



Video camera

As an option, the pyrometer can be equipped with a built-in colour video camera to view the target. Based on the latest HDR (High Dynamic Range) technology, the camera provides a higher dynamic range from the

imaging process and automatic exposure control. The video image appears without over-exposure and glare.

Another special feature is TBC (target brightness control). The light sensitivity adapts dynamically to the target object captured within the measurement spot to produce a high-contrast image of the target, re-gardless of whether the object focused on is cooler or hotter than the background.

The white balance can be switched to either „automatic“ or „daylight“ mode. The video signal also transmits the measurement data. The temperature reading is superimposed onto the screen. A separate PC is not required.

A video image allows you to observe possible changes in the micro-structure of the measured object relative to temperature. Because the video recording captures the temperature data in conjunction

with the visible surface behaviour, it enables in-depth data analysis and process optimisation.

The target marker shown on the screen indicates the exact size of the measuring field. With a resolution of 5.6 µm / pixel, even the tiniest target objects are visible. The video signal is electrically isolated from the supply voltage to prevent noise that may interfere with the image signal. The camera provides reliable performance and a sharp image in ambient temperatures up to 65 °C.



Thanks to the automatic exposure control and the TBC feature, the target always appears in optimum exposure. The temperature reading and the circled target spot are superimposed onto the image.



Without TBC, the light exposure would be averaged over the total illumination. A bright target object in front of a dark background would appear overexposed as shown above.

Control keys

Parameters can be configured during running operations using the rear keypad. The large control keys are easy to access and operate. The brightly lit 8 mm digits on the LED display are visible from a great distance. Four LEDs indicate the operating conditions.

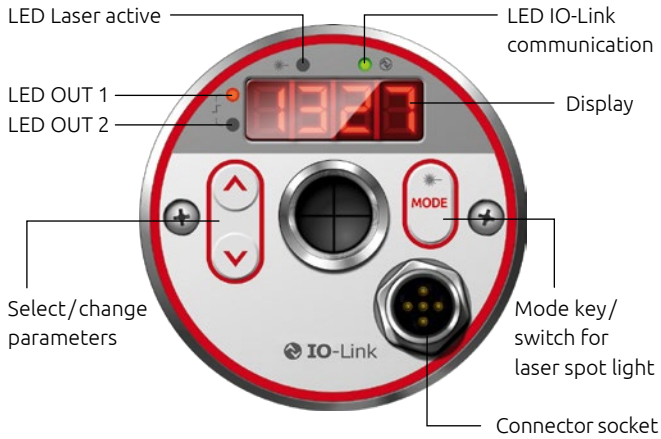

Adjustable parameters

- Measured variable and scale of analogue output signals
- Smoothing filter
- Memory mode Peak Hold, ATD
- Hold time
- Emissivity
- Transmittance
- Configuration of switching contacts
- Configuration of ATD function
- Simulation of temperature
- Temperature scale °C / °F
- Display control

In addition, for two-colour pyrometers

- One-colour/two-colour mode
- Threshold value of contamination monitoring
- Soot factor (at the CellaCombustion PX 47)

In addition, for model with camera

- TBC target brightness control
- White balance
- Measuring point number

Shipment includes

- Pyrometer CellaTemp® PX
- Connection cable VK 02/L (5 m)*
- Video cable VK 02/F (5 m)* for model with built-in camera
- Instruction manual

i * other lengths must be ordered separately

ATD function

ATD (Automatic Temperature Detection) is a feature especially useful for temperature control at discontinuous processes. With ATD, objects moving across the pyrometer's field of view at undefined intervals are automatically detected. Examples include roller steel slabs at a rolling mill stand or billets discharged from an induction heating system.

With ATD, CellaTemp® PX automatically recognizes a hot object and starts measuring the temperature. The measuring cycle either adapts dynamically to the duration of the object in the sight path, or it can be custom configured by the user. At the end of each measurement, a temperature reading is generated for each object.

Diagnostics feature

During setup and running operations, a test current or a temperature can be applied to perform diagnostic and simulation functions.

Without requiring a hot object in the field of view, it is possible to test the entire signal path to the transducer and to the control system.

Connection diagram

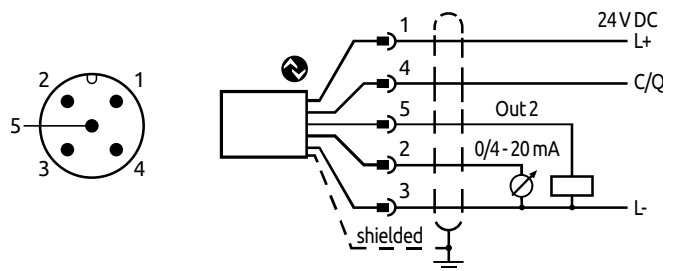

EMV standard

- DIN EN IEC 61000-6-2:11/2019
- DIN EN IEC 61000-6-4:09/2020
- BS EN IEC 61000-6-2:2019
- BS EN IEC 61000-6-4:2019

Dimensions

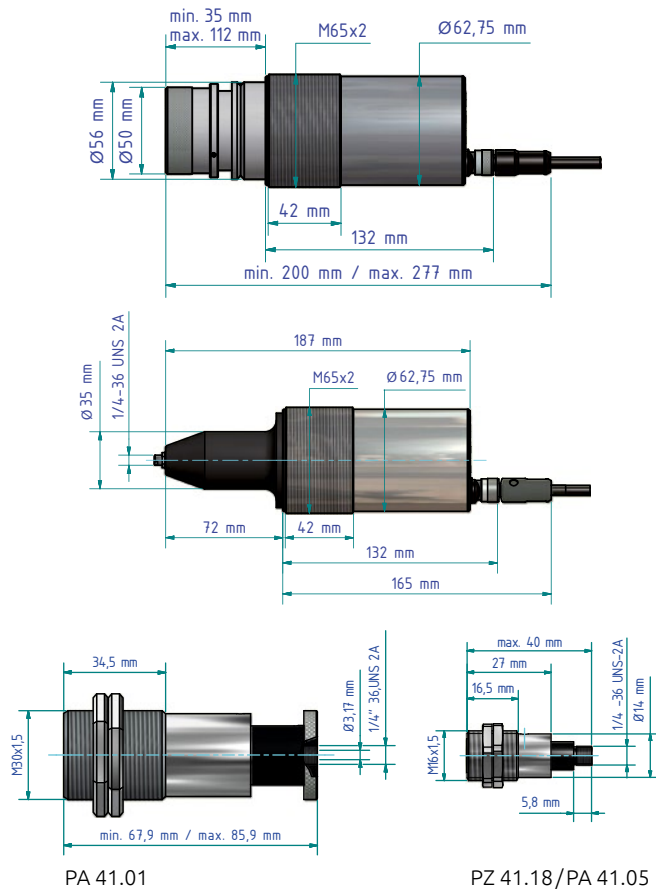

Measuring area

For pyrometers with focusable optics, the optical ratio D is defined as ratio of the measurement field over the measuring distance. The diameter of the measurement area at the focus distance results from the formula:

$$d = \frac{a}{D}$$



For models with rectangular field of view, the definition is extended to the horizontal D_H and vertical D_V optical ratio.

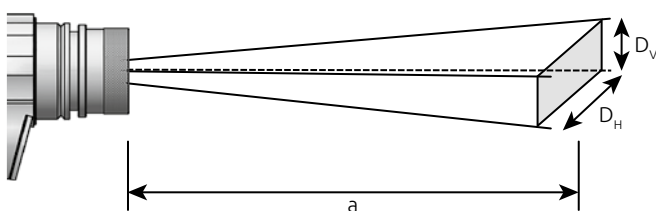

Technical Data*

Pyrometer

Analogue output

- 0/4 - 20 mA linear according to NAMUR 43, scalable
- load max. 500 Ω

Switching outputs

- PNP Open Collector active by plus supply voltage
- NC or NO contact
- Current carrying capacity 150 mA
- Safety switch-off at overload ≥ 250 mA

Interface

- IO-Link V1.1 (transmission rate 38400 Baud)

LED Display

- 4-digit (digit height 8 mm)

Resolution current output

- 0.2 K + 0.03 % of selected range

Resolution display

- 0.1 K for $T < 200$ °C
- 1 K for $T \geq 200$ °C

Resolution IO-Link

- 0.1 K

Camera

Video signal

- Composite PAL, 1Vpp, 75 Ohm

Resolution

- 722 x 576 Pixel

TBC exposure control

- automatic, across the pyrometer's entire measuring range

Operating voltage

- 18 - 32 V DC
- ripple ≤ 200 mV

Current consumption

- ≤ 135 mA
- ≤ 150 mA with laser sighting
- ≤ 175 mA with video camera

Permissible humidity

- 95 % r.H. max. (non- condensating)

Ambient temperature

- 0 - 65 °C (without cooling)

Storage temperature

- -20 - +80 °C

Housing material

- Stainless steel

Protective class

- IP65 acc. to DIN 40050

Connectivity

- M12 thread, 5-pin connection

Weight

- approx. 1 kg (depending on the model)

* Specifications of the technical data according to DIN IEC TS 62492-1 and DIN IEC TS 62492-2
Calibration of the pyrometers according to VDI / VDE 3511 sheet 4.4

Single-colour pyrometer

Model			Technical data							
Target sighting			Temp. range	Wave-length	Lens system	Focus range	Distance ratio	Response time t_{98}	Precision*	Reproducibility
Through-the-lens	Video camera	Laser spot light								
PX 10 ...			For non-metal materials, such as ceramics, wood, rubber, synthetic materials, textiles, paper							
AF 1	AF 1/C	AF 1/L	0 - 1000 °C 32 - 1832 °F	8 - 14 µm	PZ 10.01	0.30 m - ∞	50 : 1	≤ 30 ms	1 % of reading, min. 2 K based on 30 ms	1 K
AF 2	AF 2/C	AF 2/L			PZ 10.05	0.15 m - 0.30 m	48 : 1			
PX 20 ...			For metallic surfaces, ceramics, liquid glass at medium temperature range							
AF 1	AF 1/C	AF 1/L	210 - 2000 °C 410 - 3632 °F	1.1 - 1.7 µm	PZ 20.01	0.40 m - ∞	175 : 1	≤ 50 ms (T>250 °C) ≤ 2 ms (T>750 °C)	0.3 % of reading, min. 4 K	1 K
AF 2	AF 2/C	AF 2/L			PZ 20.03	0.20 m - 0.40 m	150 : 1			
AF 3	AF 3/C	AF 3/L			PZ 20.06	1.20 m - ∞	275 : 1			
AF 4	AF 4/C	AF 4/L			PZ 20.05	0.20 m - ∞	40 : 1			
AF 9	AF 9/C	AF 9/L			PA 20.06	0.60 m - ∞	380 : 1			
AF 5	AF 5/C	AF 5/L	350 - 2500 °C 662 - 4532 °F		PZ 20.01	0.40 m - ∞	175 : 1			
AF 6	AF 6/C	AF 6/L			PZ 20.03	0.20 m - 0.40 m	150 : 1			
AF 7	AF 7/C	AF 7/L			PZ 20.06	1.20 m - ∞	275 : 1			
AF 8	AF 8/C	AF 8/L			PZ 20.05	0.20 m - ∞	40 : 1			
AF 11	AF 11/C	AF 11/L			PA 20.06	0,60 m - ∞	380 : 1			
PX 30 ...			For metallic surfaces, ceramics, liquid glass at high temperature range							
AF 1	AF 1/C	AF 1/L	500 - 2500 °C 932 - 4532 °F	0.78 - 1.06 µm	PZ 20.01	0.40 m - ∞	210 : 1	≤ 50 ms (T>550 °C) ≤ 2 ms (T>750 °C)	0.3 % of reading, min. 4 K	1 K
AF 2	AF 2/C	AF 2/L			PZ 20.03	0.20 m - 0.40 m	200 : 1			
AF 3	AF 3/C	AF 3/L			PZ 20.06	1.20 m - ∞	310 : 1			
AF 4	AF 4/C	AF 4/L			PZ 20.05	0.20 m - ∞	55 : 1			
AF 5	AF 5/C	AF 5/L			PA 20.06	0.60 m - ∞	430 : 1			

*(at $\epsilon = 1$ and $T_a = +23$ °C)

Pyrometers for special applications

CellaTemp® PX 13

The CellaTemp® PX 13 was especially developed for temperature measurements in flame heated furnaces. Thanks to the selective spectral range of 3.9 µm, water vapour and CO₂ existing in the pyrometer's field of vision have no effect on the measuring results, even when measuring from large distances. This allows precise measurements through flames and combustion gases.

CellaTemp® PX 15

In the range of 4.6 - 4.9 µm glass has an emissivity of almost 100%. Above 5 µm, atmospheric influences, such as humidity or water vapour, affect the measurement. The CellaTemp® PX 15 is provided with a blocking filter with a spectral sensitivity of 4.6 - 4.9 µm, thus measuring the temperature from the near surface area of the glass.

CellaCombustion PX 17

The CellaCombustion PX 17 uses a specific wavelength, in which hot carbonaceous gases have a high optical density and therefore good radiation properties. The pyrometers are used to measure the

exhaust gas temperature in gas-fired boilers and small combustion plants.

CellaCombustion PX 18

The CellaCombustion PX 18 uses a specific wavelength, in which the chemical components of the hot combustion gas have a high optical density. The devices are used in large combustion plants such as thermal waste-disposal plants and coal power plants.

CellaTemp® PX 28

The CellaTemp® PX 28 is equipped with a light-intense lens and a special sensor and a patented signal evaluation for the reliable low temperature measuring even with extremely low infrared radiation. The pyrometer is used for low temperature measuring of metals.

CellaTemp® PX 29

CellaTemp® PX 29 was designed with a special band-stop filter and sensor which ignore interfering IR radiation from sources such as day-

light or laser beams. CellaTemp® PX 29 features a response spectrum which is far less sensitive to incidental light reflections from nearby hot objects than most commonly available pyrometers which are responsive at short wavelengths. The individual components and subassemblies can be combined in different ways, yielding 24 instrument variants. In combination with supplementary lenses the CellaTemp® PX 29 can capture target spots as small as Ø 0.3 mm. Due to the wide temperature ranges and the numerous varieties of available optics, the CellaTemp® PX 29 provides maximum versatility. It is suitable for various applications in the metalworking industry, and is ideal for measuring reflective metals and aluminium at low temperatures. With its band-stop filter, the CellaTemp® PX 29 is highly accurate in capturing the temperature of metal surfaces which are heat-treated by diode, Nd:YAG or CO₂ lasers without being affected by the extremely high laser energy. This means that the pyrometer can be used for PVD (physical vapour deposition) coating processes.

CellaTemp® PX 35

The CellaTemp® PX 35 features a narrow-band, short wavelength spectral response to minimize the effect of interferences which lead to measurement errors. Detectors which respond to narrow wavebands at short wavelengths are far less susceptible to fluctuating emissivity or signal attenuation due to sight path obstructions such as dust, steam, smoke or a dirty lens. Metal surfaces, for example, exhibit higher emissivity at shorter wavelengths and at higher temperatures. Due to the special wavelength, CellaTemp® PX 35 is especially suitable for temperature detection of metals and high-temperature applications. The pyrometer's specific spectral sensitivity is also ideal for the silicon wafer production process. Silicon is transparent at wavelengths > 1µm. Standard pyrometers will see through the silicon surface and detect the temperature of the material behind it.

CellaCrystal PX 44

The Cella Crystal PX 44 has been developed for optical temperature measurement in the production of Si and SiC crystals. The calibration is especially adapted to the growth process. Because of the hybrid signal evaluation with a constantly high resolution of < 0.1 K over the entire measuring range and the very high long-term stability of the uniform light sensor technology, the instruments meet the high demands on the required measuring accuracy.

CellaCrystal PX 45

The CellaCrystal PX 45 two-colour pyrometer is characterised by a very wide measuring range of 900 - 3200 °C. Thanks to hybrid signal processing, it has a consistently high signal resolution and extremely high long-term stability over the entire measuring range. This makes it ideal for carbonising, graphitising and crystal growing.

CellaCombustion PX 47

The CellaCombustion PX 47 is a special pyrometer for non-contact temperature measurement of sooty flames in coal power plants or waste incineration plants. The measurement and signal processing based on the two-colour method detects the heat radiation of the sooty particles of the flame in the near infrared range at two wavelengths. The burn-out operation can be controlled by the flame temperature to reduce the pollutant emission and to minimize the slagging of the walls in the combustion chamber.

CellaCrystal PX 64

The CellaCrystal PX 64 is used for temperature measurement in CVD (chemical vapour deposition) coating processes. Due to the special wavelength, the pyrometer can also be used for plasma-assisted vapour deposition.

Pyrometers for special applications

Model			Technical data							
Through-the-lens	Video camera	Laser spot light	Temp. range	Wave-length	Lens system	Focus range	Distance ratio	Response time t ₉₈	Precision*	Reproducibility
AF 1	AF 1/C	AF 1/L	500 - 1600 °C 932 - 2912 °F	3.9 µm	PZ 15.03	0.80 m - ∞	45 : 1	≤ 100 ms	1 % of reading	2 K
PX 15 ... For glass surfaces										
AF 1	AF 1/C	AF 1/L	500 - 2500 °C 932 - 4532 °F	4.6 - 4.9 µm	PZ 15.03	0.80 m - ∞	70 : 1	≤ 100 ms	0.75 % of reading	2 K
AF 2	AF 2/C	AF 2/L	300 - 1300 °C 572 - 2372 °F		PZ 15.03	0.80 m - ∞	45 : 1		0.75 % of reading, min. 3 K	
PX 17 ... For measurements in environments with hot, CO ₂ -containing gases (e.g. in gas-fired boilers and small combustion plants)										
AF 1	AF 1/C	—	400 - 2000 °C 752 - 3632 °F	CO ₂ range	PZ 15.03	0.80 m - ∞	75 : 1	≤ 100 ms	0.75 % of reading + 1 K	2 K
PX 18 ... For measurements in environments with hot, CO-containing gases (e.g. in thermal waste-disposal plants and coal power plants)										
AF 1	AF 1/C	—	500 - 2500 °C 932 - 4532 °F	CO range	PZ 15.03	0.80 m - ∞	70 : 1	≤ 100 ms	0.75 % of reading	2 K

Pyrometers for special applications

Model			Technical data							
Through-the-lens	Video camera	Laser spot light	Temp. range	Wave-length	Lens system	Focus range	Dis-tance ratio	Response time t ₉₈	Precision*	Repro-ducibility
AF 10	AF 10/C	AF 10/L	75 - 650 °C 167 - 1202 °F	1.8 - 2.4 μm	PZ 20.08	0.30 m - ∞	48 : 1	≤ 200 ms (T>75 °C) ≤ 50 ms (T>100 °C) ≤ 15 ms (T>125 °C) ≤ 2 ms (T>200 °C)	0.75 % of reading, min. 3 K	1 K
PX 29 ... For measurements of aluminium, polished metal surfaces, at laser applications and in PVD coating processes										
AF 10	AF 10/C	AF 10/L	150 - 800 °C 302 - 1472 °F	1.8 - 2.2 μm	PZ 20.08	0.30 m - ∞	48 : 1	≤ 50 ms (T>150 °C) ≤ 15 ms (T>200 °C) ≤ 2 ms (T>350 °C)	0.75 % of reading, min. 5 K	1 K
AF 21	AF 21/C	AF 21/L	180 - 1200 °C 356 - 2192 °F		PZ 20.01	0.40 m - ∞	60 : 1	≤ 75 ms (T>180 °C)		
AF 22	AF 22/C	AF 22/L			PZ 20.03	0.20 m - 0.40 m	56 : 1	≤ 35 ms (T>200 °C) ≤ 5 ms (T>300 °C)		
AF 23	AF 23/C	AF 23/L			PZ 20.06	1.20 m - ∞	96 : 1	≤ 2 ms (T>600 °C)		
AF 1	AF 1/C	AF 1/L	250 - 2000 °C 482 - 3632 °F		PZ 20.01	0.40 m - ∞	210 : 1	≤ 50 ms (T>250 °C) ≤ 2 ms (T>750 °C)	0.5 % of reading, min. 4 K	
AF 2	AF 2/C	AF 2/L			PZ 20.03	0.20 m - 0.40 m	200 : 1			
AF 3	AF 3/C	AF 3/L			PZ 20.06	1.20 m - ∞	310 : 1			
AF 4	AF 4/C	AF 4/L			PZ 20.05	0.20 m - ∞	55 : 1			
PX 35 ... For the precise measurement of metals, very high temperatures and semiconductors										
AF 1	AF 1/C	AF 1/L	600 - 3000 °C 1112 - 5432 °F	0.82 - 0.93 μm	PZ 20.01	0.40 m - ∞	210 : 1	≤ 50 ms (T>650 °C) ≤ 2 ms (T>850 °C)	0.3 % of reading, min. 4 K	1 K
AF 2	AF 2/C	AF 2/L			PZ 20.03	0.20 m - 0.40 m	200 : 1			
AF 3	AF 3/C	AF 3/L			PZ 20.06	1.20 m - ∞	310 : 1			
AF 4	AF 4/C	AF 4/L			PZ 20.05	0.20 m - ∞	55 : 1			
AF 5	AF 5/C	AF 5/L			PA 20.06	0.60 m - ∞	430 : 1			
PX 44 ... For the precise measurement of Si and SiC crystals										
AF 4	AF 4/C	AF 4/L	750 - 2400 °C 1382 - 4352 °F	0.95/ 1.05 μm	PZ 20.01	0.40 m - ∞	150 : 1	≤ 10 ms (T>950 °C)	6K (< 850 °C) 0.35% + 2K (850..1500 °C) 0.5% + 2K (> 1500 °C)	2 K
AF 7	AF 7/C	AF 7/L	850 - 3000 °C 1562 - 5432 °F		PZ 20.01	0.40 m - ∞	150 : 1	≤ 10 ms (T>1050 °C)	0.35% + 2K (< 1500 °C) 0.5% + 2K (1500..2400 °C) 1.0% (> 2400 °C)	
PX 45 ... For measurement in graphite production and crystal growth										
AF 1	AF 1/C	–	900 - 3200 °C 1652 - 5792 °F	0.9/ 1.05 μm	PZ 20.01	0.40 m - ∞	210 : 1	≤ 10 ms	as with the PX 44 AF 7	2 K
PX 47 ... For the measurement of sooty flames (e.g. in power plants or incineration plants)										
AF 1	AF 1/C	–	700 - 1700 °C 1292 - 3092 °F	0.8/ 1.05 μm	PZ 20.01	0.40 m - ∞	80 : 1	≤ 20 ms (T>650 °C) ≤ 10 ms (T>750 °C)	1 % of reading	2 K
PX 64 ... For the measurement in CVD coating processes										
AF 2	AF 2/C	AF 2/L	500 - 1400 °C 932 - 2552 °F	1.5/ 1.9 μm	PZ 20.03	0.20 m - 0.40 m	75 : 1	≤ 30 ms	0.75 % of reading, min. 4 K	2 K

*(at ε = 1 and Ta = +23 °C)

Compact two-colour pyrometer

The two-colour pyrometers of the PX series detect the infrared radiation emitted from an object's surface at two separate wavelengths. The dual sandwich detector uses a two-element photo-diode to capture both radiation intensities simultaneously from the exact same spot. The pyrometer produces temperature data based on the ratio of these two intensities. The advantage of the two-colour or dual wavelength technique is that the pyrometer will still produce highly accurate temperature data, even at signal attenuation of up to 90%. The two-colour or ratio pyrometer is far less sensitive to contaminants in the line of sight such as steam, dust or smoke than a standard single-colour pyrometer. Even if other sources impair the visibility such as dirt on the pyrometer lens or sediment and debris buildup within the sight tube, it has up to a certain degree no influence on the measurement value. When the signal is equally attenuated at both wavelengths, this will have no impact on the accuracy of the temperature reading. The two-colour method enables the pyrometer to correct for measurement errors which would otherwise occur when a material's emissivity varies as a function of temperature or surface

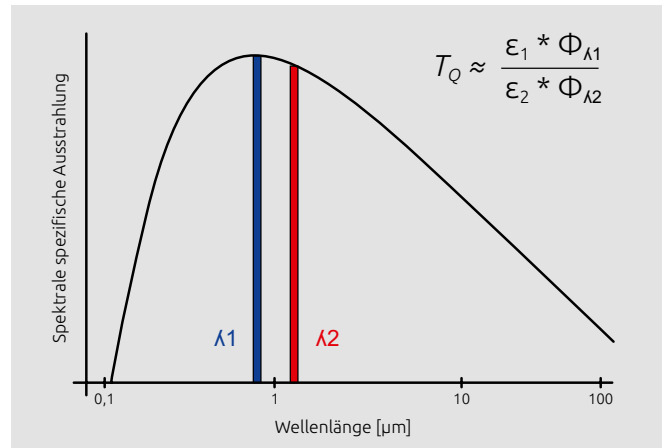

properties, or when the pyrometer is used at a production line which produces a variety of products having different emissivities.

Model			Technical data							Precision*	Reproducibility
Target sighting	Temp. range	Wave-length	Lens system	Focus range	Distance ratio	Response time t ₉₈					
Through-the-lens	Video camera	Laser spot light									
PX 40 ...			For use in these industries: steel, ceramics or cement in harsh environments								
AF 20	AF 20/C	AF 20/L	500 - 1400 °C 932 - 2552 °F	0.95/ 1.05 μm	PZ 20.08	0.30 m - ∞	55 : 1	≤ 10 ms (T>650 °C)	1 % of reading	2 K	
AF 1	AF 1/C	AF 1/L	650 - 1700 °C 1202 - 3092 °F		PZ 20.01	0.40 m - ∞	80 : 1				≤ 20 ms (T>650 °C) ≤ 10 ms (T>750 °C)
AF 2	AF 2/C	AF 2/L			PZ 20.03	0.20 m - 0.40 m	75 : 1				
AF 3	AF 3/C	AF 3/L			PZ 20.06	1.20 m - ∞	120 : 1				
AF 10	AF 10/C	AF 10/L			PZ 20.05	0.20 m - ∞	20 : 1				
AF 13	AF 13/C	AF 13/L			PZ 20.08	0,30 m - ∞	55 : 1				
AF 21	AF 21/C	AF 21/L			PA 20.06	0.60 m - ∞	190 : 1				
AF 4	AF 4/C	AF 4/L	750 - 2400 °C 1382 - 4532 °F		PZ 20.01	0.40 m - ∞	150 : 1	≤ 10 ms (T>950 °C)			
AF 5	AF 5/C	AF 5/L			PZ 20.03	0.20 m - 0.40 m	140 : 1				
AF 6	AF 6/C	AF 6/L			PZ 20.06	1.20 m - ∞	240 : 1				
AF 11	AF 11/C	AF 11/L			PZ 20.05	0.20 m - ∞	35 : 1				
AF 14	AF 14/C	AF 14/L			PZ 20.08	0,30 m - ∞	100 : 1				
AF 22	AF 22/C	AF 22/L			PA 20.06	0.60 m - ∞	370 : 1				
AF 7	AF 7/C	AF 7/L	850 - 3000 °C 1562 - 5432 °F		PZ 20.01	0.40 m - ∞	150 : 1	≤ 10 ms (T>1050 °C)			
AF 8	AF 8/C	AF 8/L			PZ 20.03	0.20 m - 0.40 m	140 : 1				
AF 9	AF 9/C	AF 9/L			PZ 20.06	1.20 m - ∞	240 : 1				
AF 12	AF 12/C	AF 12/L			PZ 20.05	0.20 m - ∞	35 : 1				
AF 15	AF 15/C	AF 15/L			PZ 20.08	0,30 m - ∞	100 : 1				
AF 18	AF 18/C	AF 18/L			PA 40.01	86 mm - 115 mm	250 : 1				
AF 23	AF 23/C	AF 23/L	PA 20.06		0.60 m - ∞	370 : 1					
PX 50 ...			For measurements of materials with varying emissivity								
AF 1	AF 1/C	AF 1/L	500 - 1400 °C 932 - 2552 °F	0.95/ 1.55 μm	PZ 20.01	0.40 m - ∞	80 : 1	≤ 30 ms	1 % of reading	2 K	
AF 2	AF 2/C	AF 2/L			PZ 20.03	0.20 m - 0.40 m	75 : 1				
AF 3	AF 3/C	AF 3/L			PZ 20.06	1.20 m - ∞	120 : 1				
AF 4	AF 4/C	AF 4/L			PZ 20.05	0.20 m - ∞	20 : 1				
PX 60 ...			For measurements at low temperatures from 300 °C								
AF 1	AF 1/C	AF 1/L	300 - 800 °C 572 - 1472 °F	1.5/ 1.9 μm	PZ 20.08	0.30 m - ∞	39 : 1	≤ 30 ms	1 % of reading	2 K	
AF 11	AF 11/C	AF 11/L	400 - 1000 °C 752 - 1832 °F		PZ 20.01	0.40 m - ∞	80 : 1				

*(at ε = 1 and Ta = +23 °C)

Panorama pyrometer® with rectangular measurement area

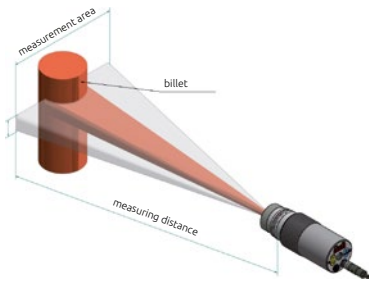

The CellaTemp® PX 43, a panorama pyrometer®, features a rectangular measurement area. The unique design enables the pyrometer to detect the temperature of target objects which move within the rectangular area. This is accomplished without requiring any moving parts.

The CellaTemp® PX 43 reliably captures objects which typically show fluctuating behaviour (such as swaying wires). The rectangular area is also ideal when measuring objects whose position tends to vary during the production process. Such objects include billets or metal rods at a roller table.

A rectangular measurement field simplifies pyrometer alignment and focusing in applications which involve small measurement objects. The pyrometer models can be combined with supplementary lenses for very small targets such as filaments.

Model			Technical data							Precision*	Reproducibility
Through-the-lens	Video camera	Laser spot light	Temp. range	Wave-length	Lens system	Focus range	Distance ratio	Response time t_{98}			
PX 43 ...			For use in these industries: steel, ceramics, or cement in harsh environments								
AF 20	AF 20/C	AF 20/L	600 - 1400 °C 1112 - 2552 °F	0.95/ 1.05 µm	PZ 20.08	0.30 m - ∞	$D_v = 150 : 1$ $D_h = 30 : 1$	≤ 10 ms (T>650 °C)	1.5 % of reading	3 K	
AF 1	AF 1/C	AF 1/L			PZ 20.01	0.40 m - ∞	$D_v = 230 : 1$ $D_h = 45 : 1$				
AF 2	AF 2/C	AF 2/L	PZ 20.03		0.20 m - 0.40 m	$D_v = 215 : 1$ $D_h = 40 : 1$					
AF 3	AF 3/C	AF 3/L	PZ 20.06		1.20 m - ∞	$D_v = 375 : 1$ $D_h = 75 : 1$					
AF 10	AF 10/C	AF 10/L	PZ 20.05		0.20 m - ∞	$D_v = 55 : 1$ $D_h = 10 : 1$					
AF 13	AF 13/C	AF 13/L	PZ 20.08		0.30 m - ∞	$D_v = 150 : 1$ $D_h = 30 : 1$					
AF 21	AF 21/C	AF 21/L	PA 20.06		0.60 m - ∞	$D_v = 500 : 1$ $D_h = 95 : 1$					
AF 4	AF 4/C	AF 4/L	PZ 20.01		0.40 m - ∞	$D_v = 350 : 1$ $D_h = 50 : 1$					
AF 5	AF 5/C	AF 5/L	PZ 20.03		0.20 m - 0.40 m	$D_v = 330 : 1$ $D_h = 45 : 1$					
AF 6	AF 6/C	AF 6/L	PZ 20.06		1.20 m - ∞	$D_v = 580 : 1$ $D_h = 85 : 1$					
AF 11	AF 11/C	AF 11/L	PZ 20.05		0.20 m - ∞	$D_v = 85 : 1$ $D_h = 11 : 1$					
AF 14	AF 14/C	AF 14/L	PZ 20.08		0.30 m - ∞	$D_v = 230 : 1$ $D_h = 34 : 1$					
AF 17	AF 17/C	AF 17/L	PA 40.01	86 mm - 115 mm	$D_v = 380 : 1$ $D_h = 80 : 1$						
AF 22	AF 22/C	AF 22/L	PA 20.06	0.60 m - ∞	$D_v = 730 : 1$ $D_h = 105 : 1$						
AF 7	AF 7/C	AF 7/L	PZ 20.01	0.40 m - ∞	$D_v = 350 : 1$ $D_h = 50 : 1$						
AF 8	AF 8/C	AF 8/L	PZ 20.03	0.20 m - 0.40 m	$D_v = 330 : 1$ $D_h = 45 : 1$						
AF 9	AF 9/C	AF 9/L	PZ 20.06	1.20 m - ∞	$D_v = 580 : 1$ $D_h = 85 : 1$						
AF 12	AF 12/C	AF 12/L	PZ 20.05	0.20 m - ∞	$D_v = 85 : 1$ $D_h = 11 : 1$						
AF 15	AF 15/C	AF 15/L	PZ 20.08	0.30 m - ∞	$D_v = 230 : 1$ $D_h = 34 : 1$						
AF 18	AF 18/C	AF 18/L	PA 40.01	86 mm - 115 mm	$D_v = 380 : 1$ $D_h = 80 : 1$						
AF 23	AF 23/C	AF 23/L	PA 20.06	0.60 m - ∞	$D_v = 730 : 1$ $D_h = 105 : 1$						
			750 - 2400 °C 1382 - 4532 °F					≤ 10 ms (T>950 °C)			
			850 - 3000 °C 1562 - 5432 °F					≤ 10 ms (T>1050 °C)			

* (at $\epsilon = 1$ and $T_a = +23$ °C)

Single-colour / two-colour fibre optics pyrometer



A pyrometer with fibre optics has the sensor head housed separately from the electronics assembly. A fibre optic cable transmits the detected infrared energy to the electronics. The optical sensor head can withstand ambient temperatures up to 250 °C without cooling.

Both the sensor head and the fibre optic cable are unsusceptible to electromagnetic radiation. Pyrometers with fibre optics are ideal for cramped, hard-to-access locations. Three different focusable optical

heads are available. Select the one most suitable, depending on the required target size and measuring distance.

For target sighting and focussing, the pyrometer features a built-in laser spot light. At the focal distance, the laser spot light indicates the exact size of the measuring area. This allows the measurement position and focus setting to be checked exactly.

The optical fibre can be supplied at a length of up to 50 m, ensuring that the electronics can be installed at a safe distance. The fibre optic cable is equipped with a screw connector at each end to ease installation and detachment. Metallic armouring provides the optical fibre with a high degree of mechanical protection.

Model	Technical data									
Type	Temp. range	Wave-length	Lens system	Focus range	Distance ratio	Method	Response time t_{98}	Precision*	Reproducibility	
PX 21 ...	For metallic surfaces, ceramics, liquid glass at medium temperature range									
AF 11	250 - 2000 °C 482 - 3632 °F	1.1 - 1.7 µm	PA 41.01	0.20 m - ∞	180 : 1	single-colour	≤ 50 ms (T>300 °C) ≤ 2 ms (T>800 °C)	0.75 % of reading, min. 4 K	2 K	
AF 21			PA 41.05	0.12 m - ∞	100 : 1					
AF 22			PZ 41.18	33 mm - 45 mm	50 : 1					
PX 31 ...	For metallic surfaces, ceramics, liquid glass at high temperature range									
AF 11	550 - 2500 °C 1022 - 4532 °F	0.78 - 1.06 µm	PA 41.01	0.20 m - ∞	190 : 1	single-colour	≤ 50 ms (T>600 °C) ≤ 2 ms (T>800 °C)	0.75 % of reading	2 K	
AF 21			PA 41.05	0.12 m - ∞	100 : 1					
AF 22			PZ 41.18	33 mm - 45 mm	50 : 1					
PX 36 ...	For the precise measurement of metals, very high temperatures and semiconductors									
AF 11	650 - 3000 °C 1202 - 5432 °F	0.82 - 0.93 µm	PA 41.01	0.20 m - ∞	190 : 1	single-colour	≤ 50 ms (T>680 °C) ≤ 2 ms (T>900 °C)	0.75 % of reading	2 K	
AF 21			PA 41.05	0.12 m - ∞	100 : 1					
AF 22			PZ 41.18	33 mm - 45 mm	50 : 1					
PX 41 ...	For use in these industries: steel, ceramics or cement in harsh environments									
AF 211	700 - 1800 °C 1292 - 3272 °F	0.95 - 1.05 µm	PA 41.01	0.20 m - ∞	110 : 1	two-colour	≤ 20 ms (T>850 °C)	1.5 % of reading	3 K	
AF 221			PA 41.05	0.12 m - ∞	50 : 1					
AF 222			PZ 41.18	33 mm - 45 mm	36 : 1					
AF 11	800 - 2400 °C 1472 - 4352 °F		PA 41.01	0.20 m - ∞	190 : 1		two-colour			≤ 20 ms (T>950 °C)
AF 21			PA 41.05	0.12 m - ∞	100 : 1					
AF 22			PZ 41.18	33 mm - 45 mm	50 : 1					
AF 111	900 - 3000 °C 1652 - 5432 °F		PA 41.01	0.20 m - ∞	190 : 1		two-colour			≤ 20 ms (T>1050 °C)
AF 121			PA 41.05	0.12 m - ∞	100 : 1					
AF 122			PZ 41.18	33 mm - 45 mm	50 : 1					

*(at $\epsilon = 1$ and $T_a = +23$ °C)

Accessories



Shielded cable
VK 02/L AF 1: 5 m
VK 02/L AF 2: 10 m

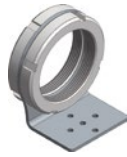

Mounting bracket
with 2 shaft nuts
PA 11/U



Mounting angle
PA 11/K



Clamping collar
PZ 20/L: Ø 70 mm
PZ 20/N: Ø 65 mm

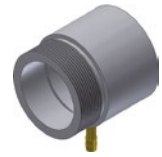

Air purge
PZ 20/A

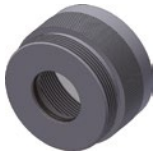

ZnS window PA 10/I
Sapphire window PA 15/I
Quartz window PA 20/I



Quick connector
ZnS window PA 10/C
Sapphire window PA 15/C
Quartz window PA 20/C

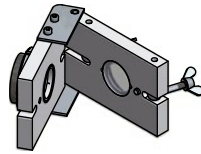

Window with hinge
PZ 10/I (ZnS-window)
PZ 15/I (CaF₂-window)
PZ 20/I (Quartz-window)

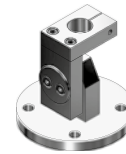

Mounting with flange
PB 08/Q AF1 (mounting)
PB 08/R AF1 (flange)

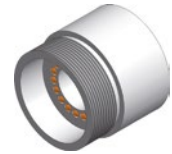

Illumination ring
PZ 10/P



Ball flange
PB 08/I



Intermediate tube
PZ 20/C



Protective enclosure,
closed PA 40/M



Cooling jacket open
PA 20/B



Cooling jacket closed
PA 20/M



Cooling jacket
PA 20/M AF2 for
pyrometer with camera

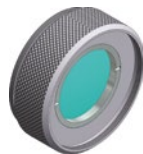

Supplementary lens
PZ 20/O



Protective glass
PZ 10/I AF 1 (ZnS)
70146 (Quartz)

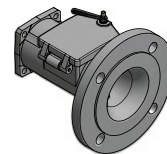

Flange tube
PB 08/M AF1



Connection head
PB 08/N



Mirror attachment
PA 20/E



Dust stop
PZ 10/T (35 mm)
PZ 20/T (20 mm)



Intermediate tube
with socket
PZ 40/C

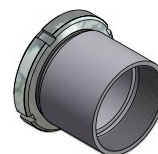

Intermediate tube
PZ 20/J



Mounting flange
PZ 20/F

Mountings

Mounting PA 20-006

consisting of:

- Air purge PZ 20/A
- Intermediate tube PZ 20/J
- Mounting bracket PA 11/U
- Mounting angle, adjustable PA 11/K

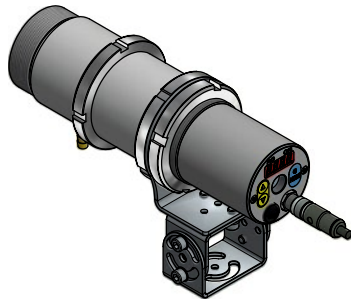

Mounting PA 83-010 for pedestal mount

consisting of:

- Dust stop PZ 10/T
- Intermediate tube PZ 20/C
- Air purge PZ 20/A
- Clamping collar PZ 20/L AF 2
- Cooling jacket, closed PA 20/M AF 1
- Hose nozzle G1/8"
- Mounting PB 08/Q AF 1
- Flange PB 08/R AF 1

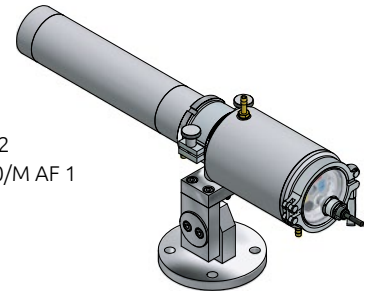

Mounting PA 20-027 for furnace installation

consisting of:

- Cooling jacket PA 20/M AF 1
- Quartz window with hinge PZ 20/I
- Air purge PZ 20/A
- Intermediate flange PZ 20/C
- Mounting flange PZ 20/F
- Dust stop PZ 20/S
- Ball flange PB 08/I

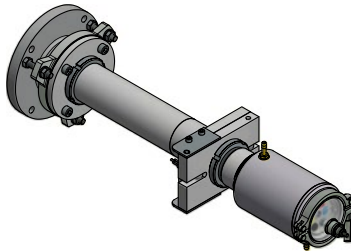

Mounting PA 20-077 for hot blast stoves

consisting of:

- Cooling jacket, closed PA 20/M AF 2
- Flange PB 08/O AF 1
- Flange tube PB 08/M AF 1

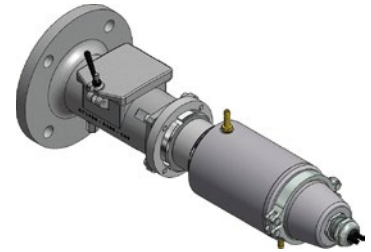

Mounting PA 20-065 for compressed air e.g. for cement industry

consisting of:

- Cooling jacket PA 20/M AF 1
- Quartz window with hinge PZ 20/I
- Air purge PZ 20/A
- Intermediate tube PZ 20/C
- Mounting flange PZ 20/F
- Dust stop PZ 20/S
- Ball flange PB 08/I
- Hose clamp 10 - 16 mm
- Industrial hose GP40
- Mounting plate in wall housing SK 613 with flow monitor

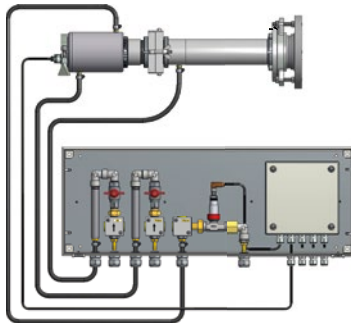

Mounting PA 20-066 for fan air e.g. for cement industry

consisting of:

- Cooling jacket PA 20/M AF 1
- Quartz window with hinge PZ 20/I
- Intermediate tube with socket PZ 40/C
- Mounting flange PZ 20/F
- Ball flange PB 08/I
- Fan PB 08/F AF 3
- Aluminium hose PB 08/L
- Hose clamps 10 - 16 mm and 50 - 70 mm
- Industrial hose GP40
- Mounting plate in wall housing SK 749 with flow monitor

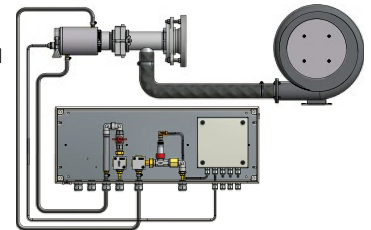

Mounting of the fibre optics version PA 21-001 for furnace installation

consisting of:

- Quartz window PS 01/I AF 2
- Bayonet coupling PS 11/N AF 5
- Air purge PS 01/A AF 1
- Shim Ø 35 mm
- Flange PS 01/N

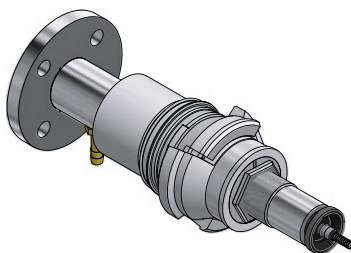

Mounting PA 20-001 with oscillating mirror for pedestal mount

consisting of:

- Oscillating mirror PZ 20/X AF 5
- Intermediate tube PZ 20/J
- Clamping collar PZ 20/L AF 2
- Mounting bracket PZ 20/U AF 2
- Protective glass M62x0,75



Special Accessories

Oscillating mirror PZ 20/X

An oscillating mirror with scanner function can be mounted to a CellaTemp® PX pyrometer.

The measurement field is deflected to capture the target object. Use the analogue output in conjunction with a RS-422 interface to collect temperature readings together with target position.

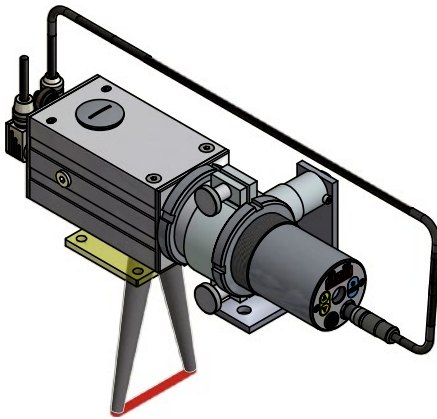

With the PZ/20 X you can:

- Detect „hot spots“ at belt conveyors
- Capture swaying wires
- Generate temperature profiles of sheet metals and steel slabs
- Measure the temperature of objects at a roller table whose size and position are not constant

The PZ 20/X accessory is supplied with CellaScan software to generate graphic images showing temperature data plotted against the scan angle.

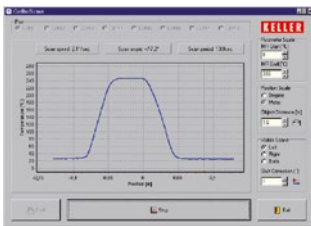

Interface converter / Video encoder



Video encoder SU 08
Video <-> Ethernet

Illumination ring PZ 10/P



In dark furnaces, it is often impossible to see the target. Installing an auxiliary light source in a second porthole can be quite difficult and costly. Thus, in actual practice, pyrometers are often focused at the target only at the time of installation. Verification of correct focusing during running operations will not be possible.

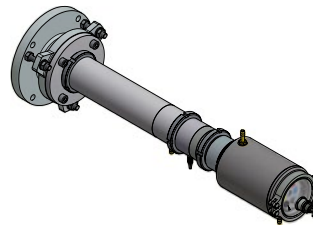

The PZ 10/P illuminates the target spot in a closed furnace, utilizing the same furnace opening in which the pyrometer is installed.

This built-in accessory is part of the pyrometer's mounting assembly.

The illumination ring helps you align and focus the pyrometer to the measurement spot at the time of initial setup. What's more, this accessory lets you view the target area anytime later, such as during routine spot checks, and make adjustments if necessary.

When used in conjunction with a pyrometer featuring a built-in video camera, you can view a live image of the illuminated target at a control room monitor.



Applications



Asphalt and concrete mixing

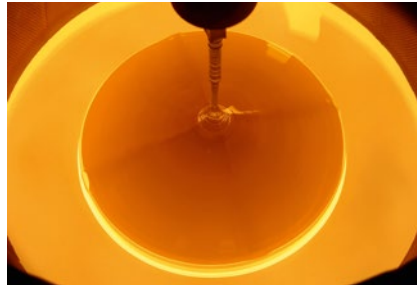

Crystal growing



Coke oven



Wires, tubes and rods



Filaments / Metal bands



Runner



Incineration plant



Rolling mill



Blast furnace / stove dome



Power plant



Continuous casting



Rotary kiln

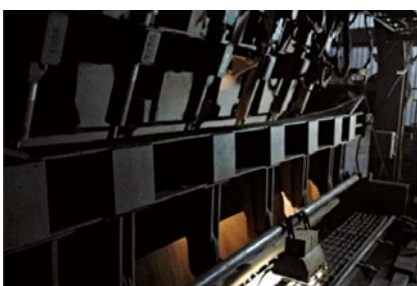

Sinter plant



Glass production



Induction heating

Other products



CellaPort PT

Portable single-colour and two-colour pyrometers with through-the-lens sighting and USB interface.



CellaCast PT

Portable pyrometer for non-contact temperature measurement of molten metal at automated casting machines and blast furnaces.

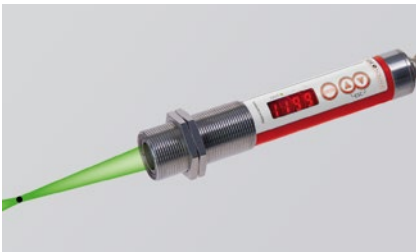

CellaTemp® PK(L)

Compact infrared thermometer for cramped environments. Optional with LED spot light.



CellaTemp® PKF

Compact infrared thermometer with optical fibre and optical sensor head.



Mikro PV

Intensity comparison pyrometer for ultra accurate measurement.



CellaSwitch

Compact infrared switch with LED display and auto-diagnostics.

Since 1967, the Division Infrared Thermometer Solutions (ITS) of KELLER HCW GmbH develops and manufactures precision instruments and systems solutions for non-contact temperature measurements. Thanks to the continuous development of its range, KELLER ITS now is one of the leading providers for infrared thermometers and pyrometers worldwide.

With its very large product range of more than 250 models and systems KELLER ITS offers solutions for all standard applications and a variety of special measuring tasks.

Following the KELLER philosophy, the key focus in the development and production of the devices is set to the high measuring accuracy and reliability. Therefore, KELLER grants a warranty of 5 years on its products.

A global network of distributors and service points ensures competent and personal consultation on site.



KELLER

Creating Solutions

infrared
temperature
solutions

ITS



- Headquarters
- Sales and Service Center
- Sales abroad



 **IO-Link**

PROFI
BUS

Keller HCW GmbH
Infrared Temperature Solutions (ITS)
Carl-Keller-Straße 2-10
49479 Ibbenbüren-Laggenbeck
Germany

www.keller.de/its
Tel. +49 (0) 5451 850
Fax +49 (0) 5451 85412
its@keller.de

Sales and Service Center

Frankreich
www.keller.de/its
Tel. +33 (0) 951 453050
its@keller.de

Italien
www.giga-tech.it
Tel. +39 (0) 296489130
contatti@giga-tech.it

Österreich
www.sensotec.at
Tel. +43 313 551 650
office@sensotec.at

Russland
www.ampermetr.com
Tel. +7 343 384 55 45
info@ampermetr.com

Spanien
www.umi.es
Tel. +34 94 446 62 50
comercial@umi.es

China
www.keller-its.cn
Tel. +86 (0) 10 828 679-20
keller@germantech.com.cn

Indien
www.keller-itsindia.com
Tel. +91 (0) 98841 11025
info@keller-itsindia.com

Korea
www.ultratec.co.kr
Tel. +82 (0) 70 8282 5979
ellen@ultratec.co.kr