

 **IO-Link**



Pyrometer
CellaTemp
PK / PKF / PKL xx

Ident no.: 1086017 02/2019

Content

1	General	4
1.1	Information about this manual	4
1.2	Explanation of symbols	4
1.3	Liability and Warranty	4
1.4	Copyright	5
2	Safety	5
2.1	Intended use	5
2.2	User's responsibility	5
2.3	Safety requirements	5
2.4	Electromagnetic Compatibility	6
3	General Description	6
4	Models	7
5	Function	8
5.1	Switching threshold	8
5.2	Output signal	8
5.3	Upper threshold delay	8
5.4	Lower threshold delay	9
5.5	Switching functions	9
5.6	Internal signal processing	9
5.7	Analogue output	10
5.8	Emissivity of materials	10
5.9	IO-Link	11
6	Electrical connection	11
7	Shielding and Grounding	12
7.1	Equipotential bonding	12
8	Operating controls and display	13
9	Menu	14
9.1	Process value display	14
9.2	Digital output OUT1	14
9.3	Analogue output OUT2	15
9.4	Advanced Features	16
10	Menu explanation	17
10.1	Digital output OUT1	17
10.2	Analogue output OUT2	17
10.3	Advanced Features	18

11	Setup	19
12	Aligning and focusing the fiber optic head	20
12.1	Safety instructions and precautions	21
13	Operating parameters	22
13.1	Setting parameters – general information	22
13.2	Test function	23
13.3	Damping function	24
13.4	Peak hold function	24
13.5	Reset all parameters to factory settings	25
14	Operation	26
14.1	Display of the configuration parameters OUT2	26
14.2	Display of the configuration parameters OUT1	26
14.3	Display of the configuration parameters Advanced Features	27
14.4	Ambient temperature	27
14.5	Error indications	27
15	Theory of Non-Contact Temperature Measurements	28
15.1	Advantages fo Non-Contact Temperature Measurement	28
15.2	Measurements an Black Bodies (Cavity Radiators)	28
15.3	Measurements of Real Radiators	29
15.4	Measurements errors	29
16	Ways to determine emissivity	30
16.1	Emissivity coefficient tables	30
17	Maintenance	33
17.1	Cleaning the pyrometer lens	33
18	Shipping, packaging and disposal	33
18.1	Inspection after shipping	33
18.2	Packaging	33
18.3	Disposal of the old devices	33
19	Accessories	34
20	General technical data	35
22	Device-specific technical data and field of view diagrams	36
22	Factory settings	65
23	Copyright	72

1 General

1.1 Information about this manual

The Operating Manual shall enable the user to properly install the pyrometer and the required accessories.

Before starting installation, be sure to read and understand this entire manual, in particular the chapter on safety! The instructions contained in this manual, especially those concerning safety, as well as site specific regulations governing UV radiation must be complied with at all times. It is imperative to comply with the safety instructions and the accident protection regulations valid for the area of application.

1.2 Explanation of symbols

Important safety-related references in this manual are marked with a symbol.

ATTENTION

This symbol points out guidelines. If you do not observe them, the device might be damaged, malfunctioning or even fail to operate.

CAUTION

This symbol points out hints and information which should be heeded for efficient and trouble-free operation

- ▶ Action
This symbol instructs the operator to take action.
- > Reaction, Result
This symbol indicates the result of the action taken.

1.3 Liability and Warranty

All information compiled in this manual is in accordance with applicable regulations. The statements made are based on state-of-the-art technology and reflect our extensive knowledge and many years of experience.

-  Always carefully read this Operating Manual before beginning any work on or with the instrument, especially prior to installation and initial setup! The Manufacturer shall not be held liable for any damages or malfunctions arising from a disregard of the warnings and instructions contained herein.

1.4 Copyright

This Operating Manual should be treated as confidential. It is solely intended for use by persons involved with the instrument. This manual may not be made available to a third party without prior Manufacturer's consent. Please contact the Manufacturer if the need should arise.

2 Safety

This chapter outlines all important safety aspects to be considered for optimum employee protection and to ensure safe and reliable operations.

2.1 Intended use

The pyrometer is solely intended for use as described in this manual. Operational safety can only be ensured when the instrument is used for its intended purpose.



The use of the pyrometer for any other purpose beyond what is specified in this manual is prohibited. Using the instrument in any other manner will be considered as improper.

The manufacturer is only liable for damage that occurs during correct use. The prerequisite for any liability, however, is that the cause of the damage is due to a defective product and the defect in the product was caused by the manufacturer.

2.2 User's responsibility

The pyrometer may only be used when it is in perfect working condition.

2.3 Safety requirements

The instrument operates at low voltage (18 – 34 V DC). The power supply unit must conform to directive EN50178, SELV, PELV.

2.4 Electromagnetic Compatibility

The devices comply with the essential safety requirements of the Electromagnetic Compatibility Directive 2014/30/EU (EMC Act).

When connecting a power supply unit, make sure that it also conforms to these standards. Radio interference may arise if the pyrometer is interconnected with such peripheral devices which have not been properly interference-suppressed. This may necessitate additional interference suppression measures.

3 General Description

The pyrometer detects temperatures and monitors temperature ranges without contact.

The sensor detects the infrared energy radiated by a hot object and converts this to an electric switch signal.

The advantage of this technique is that there is no mechanical contact between the sensor and the hot object.

The instrument is suitable for the following applications:

- Measurements at moving or hard-to-reach objects
- Measurements at surface-treated or voltage-carrying objects
- Measurements at sticky materials such as dough or aggressive chemicals
- Applications requiring fast response times.

The rugged stainless steel housing enables the instrument to be used in harsh industrial environments. The instruments are splash-proof according to IP65 (DIN 40050). The pyrometer has an analog output and a switch contact that can be used depending on the configuration as opener or closer.

4 Models

Compact pyrometer		
Model	Temp. range	Application
PK 11	0 - 1000 °C	nonmetals
PK 12	-30 - 300 °C	objects at low temperatures
PK 14	0 - 500 °C	large objects
PK 18	0 - 500 °C	nonmetals in aggressive measurement surroundings
PK 21	250 - 1600 °C	metals, ceramics, molten glass
PK 24	250 - 1600 °C	metals, ceramics, molten glass
PK 25	75 - 650 °C	metals at very low temperatures
PK 29	150 - 800 °C	metals with shiny surfaces
PK 31	500 - 2500 °C	metals, ceramics at high temperatures
PK 41	300 - 1300 °C	glass surfaces
PK 42	500 - 2500 °C	glass surfaces
PK 51	400 - 1400 °C	flame-heated furnaces
PK 52	500 - 2000 °C	flame-heated furnaces
PK 72	400 - 2000 °C	Hot combustion gases (CO ₂)

Pyrometer with fibre optic cable and optical head		
Model	Temp. range	Application
PKF 26	300 - 1600 °C	metals, ceramics, molten glass
PKF 36	550 - 2500 °C	metals, ceramics at high temperatures

Pyrometer with LED pilot light		
Model	Temp. range	Application
PKL 11	0 - 1000 °C	nonmetals
PKL 28	250 - 1600 °C	metals, ceramics, molten glass
PKL 29	180 - 1200 °C	metals with shiny surfaces
PKL 38	500 - 2500 °C	metals, ceramics at high temperatures

EN

5 Function

The pyrometer measures the temperature without contact to the target.

The infrared sensor is equipped with an analogue output and an open collector output. The instrument's display panel shows the measured temperature.

- It generates 2 output signals according to the configured function:

OUT1	Switching threshold
OUT2	Analogue output 0/4...20mA

5.1 Switching threshold

OUT1 changes its switching status when the configured upper and lower thresholds ($[d_{\alpha S P}]$, $[d_{\alpha R P}]$) are exceeded.

First set the upper temperature value of the switching point $[d_{\alpha S P}]$. The temperature can be defined in °C or °F according to the unit setting. Then set the lower threshold $[d_{\alpha R P}]$. When you adjust the upper threshold $[d_{\alpha S P}]$ the lower threshold $[d_{\alpha R P}]$ will change accordingly. The span remains the same. If $[d_{\alpha S P}]$ is lowered to a value where the span cannot be maintained (as $[d_{\alpha R P}]$ would then fall below its minimum value), the $[d_{\alpha R P}]$ is kept with its minimum value. If $[d_{\alpha S P}]$ subsequently increases again, $[d_{\alpha R P}]$ also immediately increases. The minimum distance between $[d_{\alpha S P}]$ and $[d_{\alpha R P}]$ is 2 K.

5.2 Output signal

The following switching functions can be selected:

- Normally open contact: $[d_{\alpha}] \rightarrow [d_{\alpha F n}] = n o$ (normally open)
- Normally closed contact: $[d_{\alpha}] \rightarrow [d_{\alpha F n}] = n c$ (normally closed)

5.3 Upper threshold delay

Once the sensor has detected a temperature which exceeds the switching threshold $[d_{\alpha S P}]$ the time delay $[d_{\alpha d S}]$ starts running. When this delay period has elapsed, the output OUT1 activates switching. This status is sustained until the lower threshold $[d_{\alpha R P}]$ is violated. If this occurs before the time delay has elapsed, the delay will reset. This function can be used, for example, to suppress spurious impulse signals at the output.

- Upper threshold delay: $[d_{\alpha}] \rightarrow [d_{\alpha d S}] = 0...10$ sec.

5.4 Lower threshold delay

- To make sure the output impulse is correctly identified, e.g. by a downstream control system, the output impulse can be lengthened.
- Lower threshold delay: $[do] \rightarrow [dodr] = 0...10 \text{ sec}$.

5.5 Switching functions

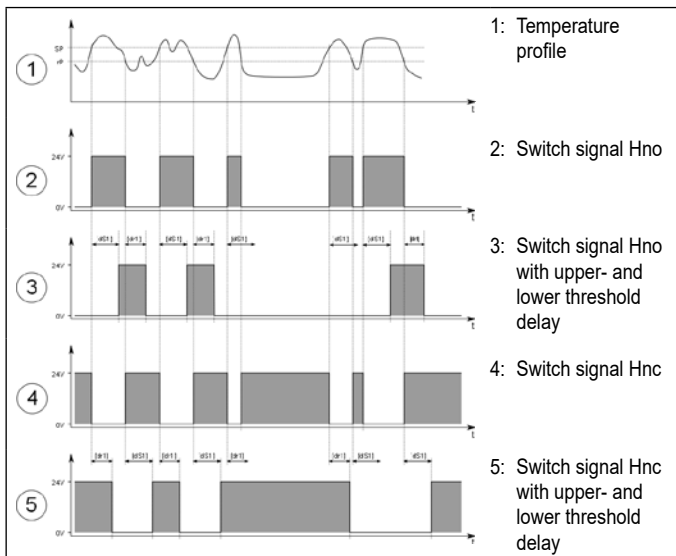

EN

5.6 Internal signal processing

Temperature

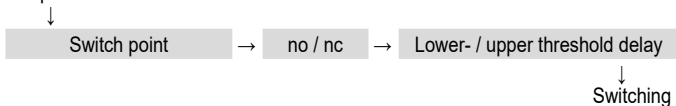

5.7 Analogue output

The pyrometer is equipped with an analogue output OUT2 0/4...20 mA. The maximum load is 500 Ω. The output current is linear to the measured temperature. Within the overall measuring range, the required measuring range can be set to °C or °F using parameter [R0 _] (scale beginning) and parameter [R0 ^] (scale end). There is also the possibility, to switch OUT2 between 0 - 20 mA and 4 - 20 mA.

Scale beginning [R0] → [R0 _]

Scale end [R0] → [R0 ^]

Change 0/4 - 20 mA [R0] → [R004] = 0 - 20/4 - 20

First, the beginning of the scale [R0 _] in °C or F is entered, then the end of the scale [R0 ^]. By changing [R0 _] also changes [R0 ^], so that the range remains the same. If [R0 _] is increased so far, that the range can not be adhered to, as [R0 ^] would otherwise exceed the maximum, [R0 ^] is kept at its maximum. If [R0 _] is then reduced again, [R0 ^] is also immediately reduced again. The minimum span is given in the technical data of the respective device.

5.8 Emissivity of materials

The pyrometer reacts to the thermal energy (infrared radiation) emitted by an object. The ability to radiate heat depends on the type of material and its surface properties. A description of the calculation of emissivity is in Chapter 16/ Page 30. The ability of a body to emit infrared radiation is expressed by a material constant called emissivity coefficient or just emissivity. This coefficient lies between 0 and 100 %. A body with ideal radiation (black body) has a coefficient of 100 %. At the same temperature, bodies with real radiation emit a lower radiation. Therefore, the emissivity coefficient is < 100%. For this reason, adjust the emissivity coefficient of the target object on the pyrometer to be able to determine the exact temperature. With the configured lower emissivity coefficient, the pyrometer automatically compensates for the lower radiation.

- Emissivity: [EF] → [EPS] = 10...110%
- For the emissivity, the pyrometer has a quick adjustment function. In the process value display the value can directly be entered by using the ▲ or ▼ button without changing to the menu. When simultaneously pressing the MODE

key, the display shows the current measuring temperature while the emissivity coefficient continues to be adjusted in the background. This is an easy way to determine the emissivity when the object temperature is known. The modified values are directly adopted.

5.9 IO-Link

This device has an IO-Link communication interface, which requires an IO-Link-capable module (IO-Link master) for operation. The IO-Link interface allows direct access to process and diagnostic data and offers the possibility to parameterize the device during operation.

The IODDs required for configuring the IO-Link device as well as detailed information on process data set-up, diagnostic functions and parameter addresses are available in the download area at www.keller-its.com.



A 3-wire cable port Class A (Type A) must be used for IO-Link operation.

6 Electrical connection

⚠ ATTENTION

The pyrometer may only be installed by a skilled, qualified electrician. Do not connect the instrument while the voltage supply source is turned on. Please observe international safety regulations at all times.

- ▶ Switch to neutral and verify absence of voltage
- ▶ Connect the instrument according to the following schematic:

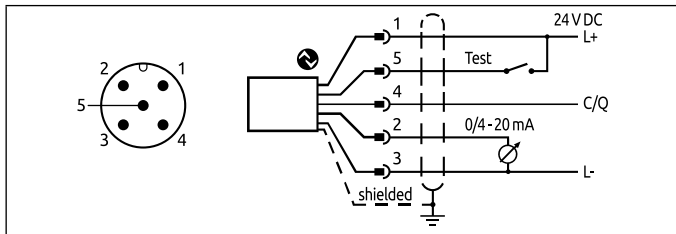

Pin 1	BN (brown)	L+ (Power supply 24V)
Pin 5	GY (grey)	Test Input
Pin 2	WH (white)	Analogue output; 0/4 ... 20mA
Pin 4	BK (black)	Open Collector switching output; $I_{\max} = 150 \text{ mA}$ or IO-Link
Pin 3	BU (blue)	L- (Shield)

! The pyrometer must be protected against high voltage and strong electromagnetic fields. Use a shielded cable, connecting it via connector casing to the device housing.

! Use a flyback diode when switching inductive loads.

! If the diagnostics function is not used, connect the diagnostics input (Pin 5) to minus. As an alternative, use a 4-pole cable box where Pin 5 is not assigned.

7 Shielding and Grounding

7.1 Equipotential bonding

The pyrometer housing is connected to the shielding via the cable connector!

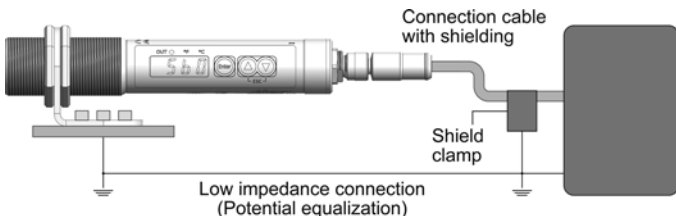

Differences in ground potentials might cause an equalising current to flow between devices through a cable shielded at both ends. In this case, be sure to install an additional equipotential bonding line.

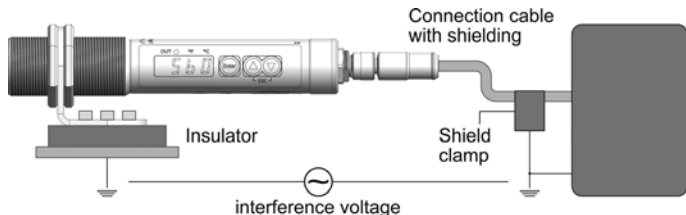

EN

To avoid an equalising current, the pyrometer can be mounted electrically insulated. The shielding must be connected to the plant's earthing system.



If the pyrometer is installed without an insulator and without potential equalisation, the interference voltage may not exceed 32V.

8 Operating controls and display

The pyrometer TW20xx features a 4-digit display, 3 control keys and 3 LEDs. The instrument's display panel shows the measured temperature.

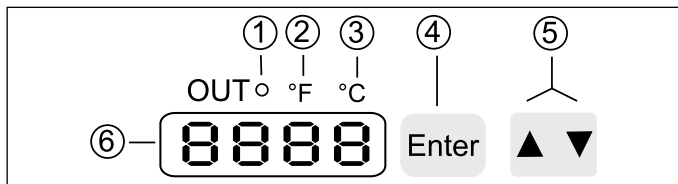

1 to 3: Indicator-LEDs

LED 1 = indicates switching output of the respective output

LED 2 = temperature in °F

LED 3 = temperature in °C

4: Control key Enter

Select parameter and confirm setting

5: Control key up and down

Adjust configuration parameters

6: Alphanumeric display, 4-digit

- Indicates temperature value
- Indicates parameters and configuration
- Indicates overload at switching output

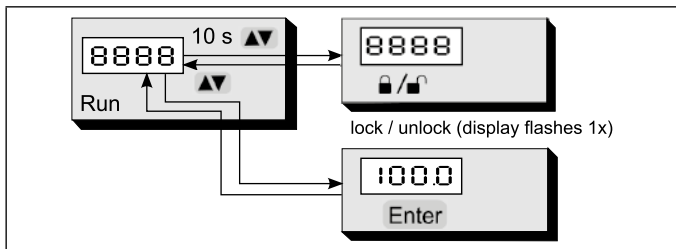
9 Menu**9.1 Process value display**

9.2 Digital output OUT1

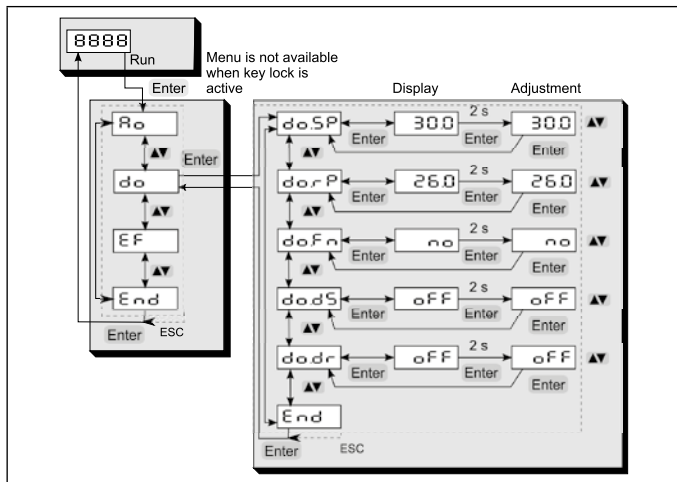

EN

9.3 Analogue output OUT2

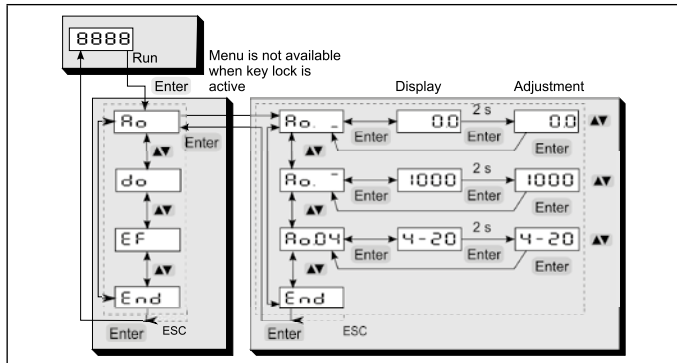

9.4 Advanced Features

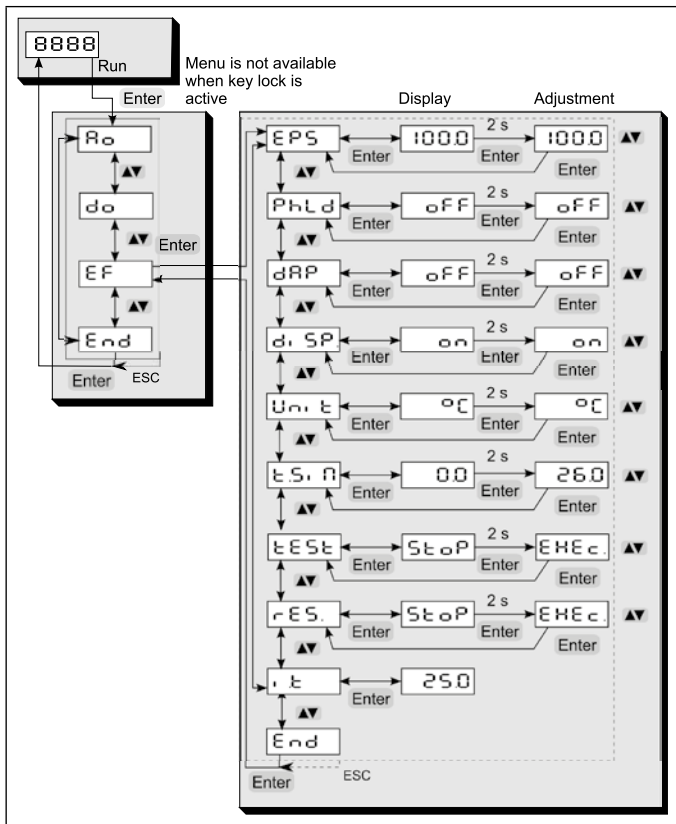

10 Menu explanation

10.1 Digital output OUT1

Parameter	Function	Comments
d _o S _P	OUT1 Upper threshold	Upper threshold which activates OUT1
d _o r _P	OUT1 Lower threshold	Lower threshold which activates OUT1
d _o F _n	Output function	n _o normally opened n _c normally closed
d _o d _S	Upper threshold delay	Value in sec (≤ 10 sec in steps of 0.1 sec)
d _o d _r	Lower threshold delay	Value in sec (≤ 10 sec in steps of 0,1 sec)
E _n d	End	

EN

10.2 Analogue output OUT2

Parameter	Function	Comments
R _a -	OUT2 Beginning of range	Analogue start value for the range of OUT2
R _a -	OUT 2 End of range	Analogue end value for the range of OUT2
R _a 04	Analogue output 0/ 4 - 20 mA	0 - 20 mA Scaling Analogue output 4 - 20 mA Scaling Analogue output
E _n d	End	

10.3 Advanced Features

Parameter	Function	Comments
EPS	Emissivity	Correction of the radiation properties of the measured object (10...110%)
PHLD	Peak hold function	Configuration of the peak hold function (OFF/ 0,1 - 999,9 s)
DRP	Damping	Damping for the temperature display, switching output and analogue output (OFF/ 0,1 - 999,9 s)
di SP.	Process value display	Specifies what is displayed in the process value display ON → current temperature value OFF → run is shown in the display
Unit	Temperature unit	Temperature displayed in °F or °C
ESN	Temperature simulation	A temperature can be simulated (affects on OUT1 and OUT2)
TEST	Test function	Activates diagnostics for self-test (10 sec. timeout)
RES	Factory settings	Reset to factory settings
IT	Internal temperature	Displays the current internal temperature
End	End	

11 Setup

The pyrometer uses the intensity of infrared radiation for non-contact temperature measurements. It is necessary to configure the pyrometer to the respective emissivity coefficient of the measuring object to obtain exact measuring results (→ 15 Emissivity coefficient tables). An incorrectly set emissivity coefficient leads to wrong temperature readings.

Set the emissivity coefficient after connecting the supply voltage or resetting the parameters to factory settings.

- ▶ Press [▲ or ▼]
- > the value of the selected emissivity is displayed, for example [1000]
- ▶ Press [▲ or ▼] until the desired emissivity is shown
- ▶ Press [Enter] or wait for 3 seconds

The current temperature value is displayed. The pyrometer now works with this configured emissivity until it is changed again.

12 Aligning and focusing the fiber optic head

The fiber optic head has to be aligned on the target. It is important to ensure that the beam path is not obstructed. If the pyrometer has a fiber optic, it could be necessary to focus the measuring head additionally.

For that, the laser pointer is to be connected to the fiber optic and to be activated by using a button!



For focal adjustment loosen the shown socket screw (hexagon socket screw DIN 916) with a wrench (DIN 911) and shift the internal body of the tube towards the lens tube.

Due to the O-ring sealing between the internal body of the tube and the lens tube the focal adjustment must be carried out very slowly so that the air pressure in the space between lens and internal body of the tube can be equalised.

Focus the sensing head until the spot light is shown as a sharp round laser spot in the target area. In bright daylight or in an excessively lit environment it is recommendable to dim the area around the target.

12.1 Safety instructions and precautions

Laser Radiation Hazard: Laser radiation can be harmful to eye!

The laser pointer operates with a class 2 red light laser. Direct prolonged viewing of a laser beam can injure the retina. There-fore, the following safety precautions must be strictly observed, otherwise the laser may not be operated!

- Only use the laser to align and focus the pyrometer. Deactivate the laser immediately afterwards.
- Never look directly into the laser beam path.
- Do not leave the instrument unattended when the laser is activated.
- Do not point the laser beam at any person.
- During pyrometer installation and alignment, make sure to avoid the possibility of laser light reflections caused by reflective surfaces.
- All currently valid laser safety standards must be observed.

Laser Power

The laser operates at a wavelength of 630 - 670 nm (visible red light). The emitted power of the laser beam at the lens opening is max. 1.0 mW. Under normal operating conditions, the emitted radiation does not present a danger to human skin. This laser product is classified according to laser class 2, IEC 60825-1.

Laser Warning Label

The black and yellow laser warning label is affixed on the laser pointer.



13 Operating parameters

When you reset/adjust the operating parameters the instrument remains in run mode. It continues to operate, using the current parameter settings, until you have finished configuring by pressing [Enter].

13.1 Setting parameters – general information

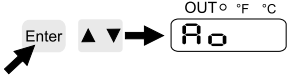
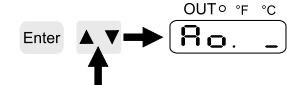
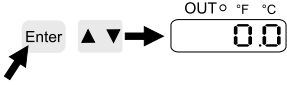
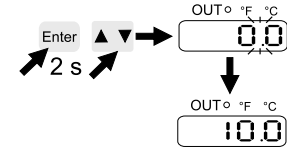
<p>1 Select parameter</p> <p>▶ Press [Enter] to access the main menu.</p>	
<p>2 Select output function</p> <p>Press key [▼] until the required output function or the Advanced Features is displayed.</p>	
<p>3 Show parameter value</p> <p>▶ Press [Enter]</p> <p>> Current parameter value is displayed. *</p>	
<p>* The pyrometer will display the parameter value for 30 sec. After that the display will once again indicate the measurement as a percentage.</p>	
<p>4 Change parameter value</p> <p>▶ Press ENTER for 2 seconds,</p> <p>> display flashes continuously</p> <p>▶ Press [▲] or [▼] to change the parameter</p> <hr/> <p>Hold key [▲] or [▼].</p> <p>> Numerical values scroll through rapidly</p>	

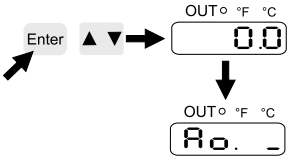
<p>5 Confirm parameter value</p> <ul style="list-style-type: none"> ▶ Press [Enter] > The display indicates the parameter. The new value has been saved and will take effect. 	
<p>Adjust additional parameters</p> <ul style="list-style-type: none"> ▶ Start again with step 2. 	
<p>Exit operating parameters layer</p> <ul style="list-style-type: none"> ▶ Wait 30 seconds <p>or</p> <ul style="list-style-type: none"> ▶ Press [▲] or [▼] to change to the parameter E_{nd}. Then press [Enter] to change to the functional menu ▶ In the functional menu press [▲] or [▼] to change to the parameter E_{nd}, then press [Enter]. 	

EN



The instrument features a keylock. Activate/deactivate the keylock as follows:

- ▶ Press key [▲▼] simultaneously and hold them down for 10 sec.
- > The display shows Loc or uLoc for 1 second to signalize the change.



If you press both keys [▲▼] only briefly, you will exit the layer (ESC function).



If [C.Loc] is displayed when attempting to change a parameter value, a change is made via a parameter setting software at the same time (temporary locking).



If [S.Loc] is displayed, the sensor is permanently locked via software. This locking can only be removed with a parameter setting software.

13.2 Test function

The pyrometer features an integrated diagnostics function to check signal processing, the switching output and the analogue output. It can be activated either using the control keys or by a static signal (10...34 V according to IEC 61131-2) on Pin

5. Voltage must be applied for at least $t > 300$ ms. The unit performs a self test. The display shows $\square L$ (analogue output 20.5 m).

To deactivate the diagnostics function, the static signal must be available for a period of 300 msec „Low“.

If the diagnostics function is activated using the control keys on the instrument, it will remain in this mode for 10 sec.

13.3 Damping function

When the target object's temperature is erratic, the damping function smoothens these temperature fluctuations in order to stabilize the measuring signal. The greater the time constant [$\square RP$], the lower the effect of these fluctuations on the yielded temperature reading.

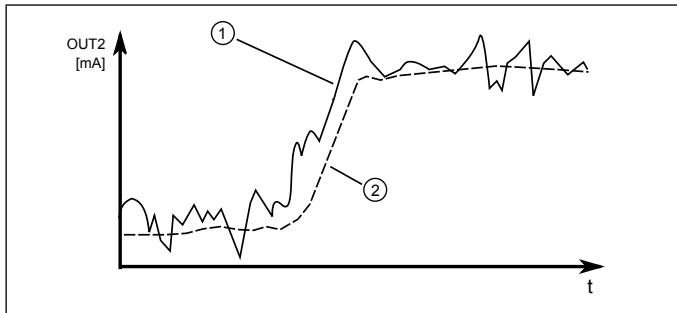

- 1: Output signal without smoothing function
- 2: Output signal with smoothing function

13.4 Peak hold function

It might often be desirable to determine the peak temperature during a defined time period, for example when the objects to be measured move past the pyrometer, resulting in temperature readings which would appear to be cyclical. In this mode, the displayed temperature reading will not drop between targeted objects. The peak temperature reading will be held for a preset time period.

The hold time [P H L d] can be set from 0.1 to 999.9 sec. The maximum temperature sampled during the defined hold time will be saved. It makes sense to choose a hold time which is approximately 1.5 times as long as the cycle of the moving targets. This avoids temperature drops. Any changes are recognised at once.

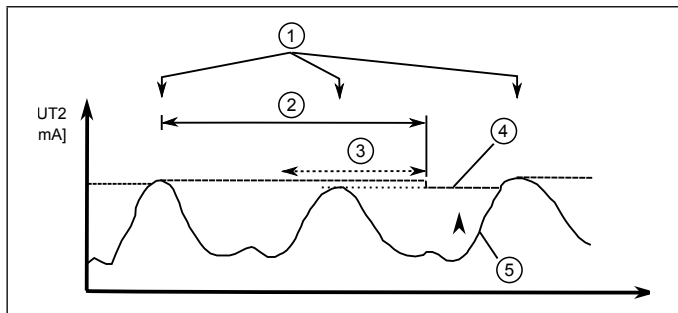

- 1: Measuring object in front of pyrometer
- 2: Hold time
- 3: second internal hold time
- 4: Measuring readings with peak hold function
- 5: Measuring readings without peak hold function

13.5 Reset all parameters to factory settings

- ▶ [r E S.] select in menu advanced functions
- ▶ Press [ENTER]
- > The display shows [STOP]
- ▶ Hold [ENTER] for 2 seconds
- > Display flashes for 2 seconds
- ▶ Press [▲]
- > The display shows [E H E c.]
- ▶ Press [ENTER]
- > The display shows the current temperature



After a reset to factory settings configure the emissivity coefficient [E P S] again (→ 11 Setup) to obtain exact measuring results.

14 Operation

After connecting the supply voltage the pyrometer will be automatically initialized and will perform a self-diagnosis. After approx. 0.5 sec the sensor is ready to operate and the instrument runs the signal processing.

14.1 Display of the configuration parameters OUT2

- ▶ Press [Enter]
- ▶ Press [▼] until the display shows the parameter [R 0].
- ▶ Press [Enter]
- ▶ Press [▼] until the required parameter is displayed.
- ▶ Press [Enter]
- > The display will indicate the parameter value for 30 sec. After that it returns to Run Mode.

14.2 Display of the configuration parameters OUT1

- ▶ Press [Enter]
- ▶ Press [▼] until the display shows the parameter [d 0].
- ▶ Press [Enter]
- ▶ Press [▼] until the required parameter is displayed.
- ▶ Press [Enter]
- > The display will indicate the parameter value for 30 sec. After that it returns to Run Mode.

14.3 Display of the configuration parameters Advanced Features

- ▶ Press [Enter]
 - ▶ Press [▼] until the display shows the parameter [E F].
 - ▶ Press [Enter]
 - ▶ Press [▼] until the required parameter is displayed.
 - ▶ Press [Enter]
- > The display will indicate the parameter value for 30 sec. After that it returns to Run Mode.

14.4 Ambient temperature

The maximum permissible ambient operating temperature for the pyrometer is 65 °C. If the instrument is used in ambient temperatures above 65 °C, it must be either cooled or shielded from excess radiant heat by means of a deflector plate.

14.5 Error indications

Overload output	The corresponding LED OUT 1 will flash at 4 Hz. The display shows "5 C !" at 2 Hz.
Overtemperature	Display $\square \text{E}$ alternately shows overtemperature and measurement reading at = 0.5 Hz. The corresponding LED flashes at 4 Hz when the output is switched off.
Incorrect connection of supply voltage	LED OUT 1 flashes at 2 Hz.
Supply voltage \leq approx. 16 V	LED, display, switching output and analogue output are deactivated. (When voltage \geq 16 V the device switches on and the switching outputs are activated).
Temperature below lower threshold	The display shows UL .
Temperature above upper threshold	The display shows OL .

15 Theory of Non-Contact Temperature Measurements

All materials radiate thermal energy in all states of aggregation above absolute zero. This radiation is mainly caused by atomic or molecular oscillations.

This temperature radiation is only a limited sector within the total electromagnetic radiation spectrum. It extends from the visible range starting at wavelengths of approx. 0.5 μm to the infrared range with wavelengths of more than 40 μm . Radiation pyrometers detect infrared radiation for non-contact temperature measurement.

15.1 Advantages of Non-Contact Temperature Measurement

- Non-contact temperature detection means cost-effective temperature measurement because this technique only requires a single investment in an instrument without any follow-up costs for consumables such as thermocouples.
- This method enables temperature detection of moving objects - quick temperature measurements within milliseconds - for example at automatic welding processes.
- Small objects with medium and high temperatures can also be easily and accurately measured.
- When measuring materials with low specific heat, a non-contact method does not induce heat loss which would distort the temperature reading (as is the case with contact temperature probes). Non-contact temperature detection is ideal with corrosive molten materials for which the use of thermocouples is hardly feasible.
- Last but not least it is also possible to measure the temperature of voltage-carrying objects.

15.2 Measurements at Black Bodies (Cavity Radiators)

A black body or a black radiator is used to calibrate radiation pyrometers. This black body is designed in a way that its radiation does not

depend on material characteristics, but only on its temperature. A black body emits at any wavelength the maximum energy possible for the specific temperature. Real bodies do not have this ability. In other words, a black body completely absorbs the radiation without reflection or transmission losses. The spectral emissivity

coefficient ϵ^* of a black body is equal to 1 or 100 %. The emissivity coefficient indicates the ratio of radiation of a real body (target) to the radiation of an ideal black body.

$$\epsilon(\lambda) = \frac{M}{M_s}$$

$\epsilon(\lambda)$: Emissivity coefficient of the object's surface (targeted spot) at wavelength λ

M: radiant energy actually emitted by a real object

M_s : radiant energy emitted by a black body (perfect radiator)

Most burning, annealing and hardening furnaces emit a radiation of nearly ,1' which corresponds to the conditions of a black body if the aperture through which the measurement is made is relatively small.

15.3 Measurements of Real Radiators

Real radiation sources are characterized by the relation of the emitted radiation to the radiation of a black body with the same temperature. Measurements outside a furnace - which applies to all other self-contained targets - always show a reading which is too low. Considerable errors can occur at targets with reflecting, polished or bright surfaces, e.g. molten steel and metal without oxide layer and ceramic materials. Exact results can only be obtained when the emissivity coefficient is correctly adjusted on the pyrometer.

The spectral emissivity coefficient of a body does not represent an exact material constant, but is also largely dependent on the surface properties (→ 16 Ways to determine emissivity).

15.4 Measurements errors

The cause of measurement errors in the use of pyrometers is often an incorrectly determined or wrong emissivity.

Another source of error is the reflected „background radiation“.

If the measurement object has a low emissivity and there are hotter objects in the surrounding area, measurement results can be affected. These objects then have to be shaded. This effect is particularly to be observed in the measurement of a colder object within a hot oven.

16 Ways to determine emissivity

Technical literature or operating manuals often contain data on the emissivity of various materials. This information should be used with caution, however. It is important to know for which temperature and which wavelength the emissivity value is applicable. Furthermore, the stated emissivity values were obtained under ideal conditions. In actual practice, the total emissivity of the target object will vary, depending on the amount of extraneous radiation transmitted through the object from the background or reflected onto the object from the foreground.

The emissivity can be determined using one of the following methods:

Contact measurements

Measure the temperature with a contact thermocouple and measure the surface temperature with a pyrometer. Adjust the emissivity coefficient on the pyrometer until both devices show the same temperature. When measuring with the thermocouple, make sure to have good thermal contact and low heat dissipation.

Using a reference emissivity coefficient

Apply matte black colour to a part of the surface to be measured. This part has an emissivity of 94 %. At first, measure the temperature of the coloured part. Then make a comparative measurement right next to the coloured part and adjust the emissivity on the pyrometer until it displays the previous measurement reading again.

16.1 Emissivity coefficient tables

List of emissivity coefficients of different materials in %.

Model	PK 11 / PK 12 / PK 14 / PK 18 / PKL 11
Wavelength λ	8 - 14 μm
„Black body“	100
Aluminium oxide	76
Asphalt	90...98
Baking oven, dark colour	96
Concrete	55...65
Bitumem (roofing paper)	96

Model	PK 11 / PK 12 / PK 14 / PK 18 / PKL 11
Bread in baking oven	88
Ferrous oxide	85...89
Enamel	84...88
Earth	92...96
Paint and varnish, bright	92
Paint and varnish, pale	96
Gypsum	80...90
Glass	85...95
Graphite	98
Rubber, black	94
Skin, human	98
Wood	80...90
Radiator	80...85
Lime cast	91
Clinker bricks, glazed	75
Cooking plate	95
Synthetic material, nontransparent	65...95
Copper, oxidized	78
Leather	75...80
Marble	94
Brass, oxidized	56...64
Paper	70...94
Sand	90
Fireclay	75
Steel, stainless	45
Steel, rusty	69
Textiles	75...88
Water	92...98
Cement	90
Bricks	93...96

Model	PK 21 / PK 24 / PKF 26 / PKL 28	PK 31 / PKF 36 / PKL 38
Wavelength λ	1.0 - 1.7 μm	0.78 - 1.06 μm
„Black body“	100	100
Aluminium, polished	5	15
Aluminium, filed smooth	10	25
Asbestos cement	60	70
Bronze, polished	1	3
Bronze, filed smooth	15	30
Chromium, polished	15	30
Iron, heavily scaled	90	95
Iron, rolling skin	75	90
Iron, liquid	15	30
Gold and silver	1	2
Graphite, filed smooth	85	90
Copper, oxidised	70	90
Brass, oxidised	50	70
Nickel	8	20
Porcelain, glazed	50	60
Porcelain, rough	75	85
Soot	90	95
Fireclay	40	50
Slag	80	85
Pottery, glazed	85	90
Bricks	85	90
Zinc	40	60

17 Maintenance

17.1 Cleaning the pyrometer lens

A false temperature reading will be given when the lens is dirty. Therefore, check the lens periodically and clean it, if necessary. Dust can be removed by simply blowing it away or by using a soft brush. A special lens cleaning cloth is ideal, but any soft, clean, lint-free cloth will be suitable. If the lens is quite dirty, use a very mild liquid detergent and rinse carefully with clear water while holding the device pointed down. Apply as little pressure as possible to avoid scratching the lens.

18 Shipping, packaging and disposal

18.1 Inspection after shipping

Unpack and inspect the entire shipment immediately upon receipt to make sure it is complete and undamaged. If the container/package shows visible signs of damage, please refuse the shipment. If this is not possible, accept the shipment on the condition that the freight carrier's delivery record is noted with the extent of the damage in order to file a claim. Should you discover a concealed loss or damage, report it to the shipper or freight carrier immediately. If the period for filing claims has expired, you will no longer be able to make any claims for compensation of damage or loss.

18.2 Packaging

The packages used are made of carefully selected, environmentally compatible materials and are thus recyclable. Please ensure that they are disposed of in an ecologically sound manner.

18.3 Disposal of the old devices



Old electrical and electronic devices frequently still contain valuable materials. These devices can be returned for disposal to the manufacturer or they must be disposed properly by the user. For the improper disposal of the device by the user, the company KELLER HCW is not responsible.

19 Accessories

Device	Type	Ident no.
shielded cable	VK 02/L AF 1: 5 m	1043813
shielded cable	VK 02/L AF 2: 10 m	1047718
laser pointer	PS 01/M AF 3	1039284
laser pointer	PS 01/P	1029357
air purge	PS 01/A	560951
air purge	PS 01/AAF 2	561553
Oscillating mirror	PZ 20/X AF 5	561630
Thermal insulating tube	PS 01/K	513522
Cooling jacket	PS 01/B AF 2	561922
Bayonet coupling	PS 11/N AF 4	561585
90° Deflection mirror	PS 11/W	561955
Supplementary tube	ZA 01/Q-35	514234
Intermediate tube	ZA 01/M	513807
Intermediate tube	ZA 01/B	513596
Intermediate tube	ZA 01/Q AF 2	515528
Clamping collar with angle	PS 11/K-35 AF 2	561558
Mounting bracket	PS 11/U	561537
Flange	PS 01/N	513303
Flange	ZA 01/I	513533
Flange	ZA 01/W	514831
Flange	DN 50	515087
Tube cap	ZA 01/A	513415
Bracket	PS 11/P	1044060
Ball flange	ZA 01/D	513431
Adapter lens	PS 27/E	561620
Quarz window	PS 01/I AF 2	561487
Saphir window	PS 15/I	1023960
ZnS-screen-adapter	PS 11/D AF 2	561488

20 General technical data

Load	max. 500 Ω
Switching output OUT1	Open Collector Ausgänge 24 V, \leq 150 mA Schaltpunkt [$^{\circ}$ C]/ Rückschaltpunkt [$^{\circ}$ C], Hysterese \geq 2 K, Ein-/Ausschaltverzögerung, NC/ NO
Ambient temperature	0 - 65 $^{\circ}$ C
IO-Link revision	V1.1, downward compatible to V1.01
SIO mode	yes, supported
Transmission rate	COM2 (38.400 Baud)
Storage temperature	-20 - 80 $^{\circ}$ C
Permissible humidity	95 % r.H. max. (non condensing)
Power requirement	24 V DC +10 % / -20 % Ripple \leq 200 mV
Housing material	Stainless steel
Weight	approx. 0.4 kg
Connectivity	5-pin connection M12 (A coded)
Protection	IP 65 according to DIN 40050 with screwed plug
Configuration parameters	Emissivity ε 10 - 110 % Smoothing function t_{98} 0,1 - 999,9 s Peak hold function 0,1 - 999,9 s

EN

21 Device-specific technical data and field of view diagrams

PK 11 AF 1/PK 18 AF 1*/PK 18 AF 2*	
Temperature range	PK 11 AF 1: 0 - 1000 °C / PK 18 AF 1: 0 - 500 °C / PK 18 AF 2: 0 - 400 °C
Sensor	Thermopile
Spectral sensitivity	8 - 14 µm
Focus distance	300 mm
Target spot diameter	11 mm
Analogue output OUT2	0(4) - 20 mA linear, switchable, scalable (≥ 50 K)
Resolution current output	0.2 K + 0.03 % of selected range
Resolution temp. reading	0.1 K < 200 °C, 1 K ≥ 200 °C
Response time t_{90}	≤ 60 ms
Repeatability [#]	1 K
Measurement uncertainty [#]	0.75 % of temp. reading [°C] plus 2.0 K
Temperature coefficient [#]	0.1 K/K (for $T < 250$ °C), 0.04 %/K (for $T > 250$ °C) of temp. reading / K
Dimensions	M30 x 185 mm (without plug)

Energy

Target diameter [mm]

95% 16.5 15.3 14.2 13 23 33 43 52 62 72 82 180 279 377 475

90% 16.5 14.7 12.8 11 20 29 39 48 57 66 75 167 259 350 442

Target distance [mm]

0 100 200 300 400 500 600 700 800 900 1000 2000 3000 4000 5000 ∞

* CellaTemp PK 18 has a special resistant lens. This allows the use even in extreme environmental conditions, such as in asphalt and concrete mixing plants, without the lens is damaged by aggressive vapors and dusts.

[#] Data applies to a thermally stabilised state.

PK 11 AF 2	
Temperature range	0 - 1000 °C
Sensor	Thermopile
Spectral sensitivity	8 - 14 µm
Focus distance	900 mm
Target spot diameter	33 mm
Analogue output OUT2	0(4) - 20 mA linear, switchable, scalable (≥ 15 K)
Resolution current output	0.2 K + 0.03 % of selected range
Resolution temp. reading	0.1 K < 200 °C, 1 K \geq 200 °C
Response time t_{90}	≤ 60 ms
Repeatability [#]	1 K
Measurement uncertainty [#]	0.75 % of temp. reading [°C] plus 2.0 K
Temperature coefficient [#]	0.1 K/K (for $T < 250^\circ\text{C}$), 0.04 %/K (for $T > 250^\circ\text{C}$) of temp. reading / K
Dimensions	M30 x 185 mm (without plug)

Energy

Target diameter [mm]

95% 16.5 18.9 21.3 23.7 26.1 28 31 33 36 38 44 105 165 226 286

90% 16.5 18.3 20.2 22 23.8 26 28 29 31 33 39 94 149 204 259

0 100 200 300 400 500 600 700 800 900 1000 2000 3000 4000 5000 ∞

Target distance [mm]

[#] Data applies to a thermally stabilised state.

PK 12 AF 1	
Temperature range	-30 - 300 °C
Sensor	Thermopile
Spectral sensitivity	8 - 14 µm
Focus distance	300 mm
Target spot diameter	18 mm
Analogue output OUT2	0(4) - 20 mA linear, switchable, scalable (≥ 15 K)
Resolution current output	0.2 K + 0.03 % of selected range
Resolution temp. reading	0.1 K < 200 °C, 1 K \geq 200 °C
Response time t_{90}	≤ 90 ms
Repeatability [#]	1 K
Measurement uncertainty [#]	0.75 % of temp. reading [°C] plus 2.0 K
Temperature coefficient [#]	0.1 K/K (for $T < 250$ °C), 0.04 %/K (for $T > 250$ °C) of temp. reading / K
Dimensions	M30 x 185 mm (without plug)

Energy	Target diameter [mm]														
95 %	16.5	17.7	18.8	20	32.2	44	57	69	81	93	105	227	349	470	592
90 %	16.5	17	17.5	18	29.5	41	53	64	76	87	99	214	329	444	559

Target diameter [mm]

Target distance [mm]

[#] Data applies to a thermally stabilised state.

PK 14 AF 1	
Temperature range	0 - 500 °C
Sensor	Thermopile
Spectral sensitivity	8 - 14 µm
Focus distance Target spot diameter	2.4:1 (90%) ≥ 1 m, calculated in the far field
Analogue output OUT2	0(4) - 20 mA linear, switchable, scalable (≥ 15 K)
Resolution current output	0.2 K + 0.03 % of selected range
Resolution temp. reading	0.1 K < 200 °C, 1 K ≥ 200 °C
Response time t_{90}	≤ 60 ms
Repeatability [#]	1 K
Measurement uncertainty [#]	0.75 % of temp. reading [°C] plus 2.0 K
Temperature coefficient [#]	0.1 K/K (for T<250°C), 0.04 %/K (for T>250°C) of temp. reading / K
Dimensions	M30 x 185 mm (without plug)

EN

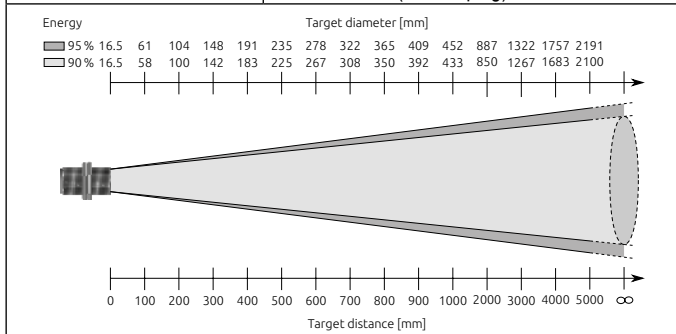

[#] Data applies to a thermally stabilised state.

PK 21 AF 1	
Temperature range	250 - 1600 °C
Sensor	InGaAs
Spectral sensitivity	1.0 - 1.7 μm
Focus distance	1500 mm
Target spot diameter	10 mm
Analogue output OUT2	0(4) - 20 mA linear, switchable, scalable (≥ 50 K)
Resolution current output	0.2 K + 0.03 % of selected range
Resolution temp. reading	1 K
Response time t_{90}	≤ 2 ms (for $T > 600$ °C)
Repeatability	1 K
Measurement uncertainty	0.3 % of temp. reading [°C] plus 2.5 K (at $\epsilon = 1.0$ and $T_a = 23$ °C)
Temperature coefficient	0.07 %/K of temp. reading / K (deviation to $T_a = 23$ °C)
Dimensions	M30 x 210 mm (without plug)

Energy	Target diameter [mm]														
95 %	11.5	11.5	11.4	11.4	11.3	11.3	11.1	10.9	18.4	26	33	41	48	56	63
90 %	11.5	11.4	11.3	11.1	11	10.9	10.3	9.7	16.8	24	31	38	45	52	59

Target diameter [mm]

Target distance [mm]

PK 24 AF 1	
Temperature range	250 - 1600 °C
Sensor	InGaAs
Spectral sensitivity	1.0 - 1.7 μm
Focus distance Target spot diameter	5.1:1 (90%) ≥ 1 m, calculated in the far field
Analogue output OUT2	0(4) - 20 mA linear, switchable, scalable (≥ 50 K)
Resolution current output	0.2 K + 0.03 % of selected range
Resolution temp. reading	1 K
Response time t_{90}	≤ 2 ms (for $T > 600$ °C)
Repeatability	1 K
Measurement uncertainty	0.3 % of temp. reading [°C] plus 2.5 K (at $\epsilon = 1.0$ and $T_a = 23$ °C)
Temperature coefficient	0.07 %/K of temp. reading / K (deviation to $T_a = 23$ °C)
Dimensions	M30 x 210 mm (without plug)

EN

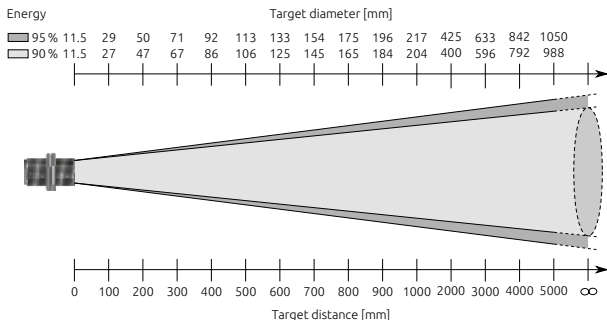

PK 25 AF 1	
Temperature range	75 - 650 °C
Sensor	ext. InGaAs
Spectral sensitivity	1.8 - 2.2 μm
Focus distance	300 mm
Target spot diameter	7 mm
Analogue output OUT2	0(4) - 20 mA linear, switchable, scalable (≥ 50 K)
Resolution current output	0.2 K + 0.03 % of selected range
Resolution temp. reading	0,1 K < 200 °C 1 K \geq 200 °C
Response time t_{90}	≤ 2 ms T > 200 °C ≤ 15 ms T > 125 °C ≤ 50 ms T > 100 °C ≤ 200 ms T > 75 °C
Repeatability	2 K
Measurement uncertainty	0.3 % of temp. reading [°C] plus 4.0 K (at $\epsilon = 1.0$ and $T_a = 23$ °C)
Temperature coefficient	0.25 K/K (for T < 500 °C), 0.05 %/K (for T > 500 °C) of temp. reading per K (deviation to $T_a = 23$ °C)
Dimensions	M30 x 210 mm (without plug)

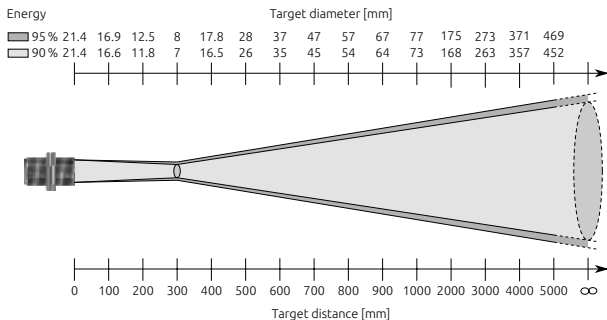

PK 29 AF 1	
Temperature range	150 - 800 °C
Sensor	ext. InGaAs
Spectral sensitivity	1.8 - 2.2 µm
Focus distance	300 mm
Target spot diameter	7 mm
Analogue output OUT2	0(4) - 20 mA linear, switchable, scalable (≥ 50 K)
Resolution current output	0.2 K + 0.03 % of selected range
Resolution temp. reading	1 K
Response time t_{90}	≤ 2 ms (for T > 300 °C) ≤ 15 ms (for T > 200 °C) ≤ 45 ms (for T > 150 °C)
Repeatability	2 K
Measurement uncertainty	0.3 % of temp. reading [°C] plus 4.0 K (at $\epsilon = 1.0$ and $T_a = 23$ °C)
Temperature coefficient	0.25 K/K (for T < 500 °C), 0.05 %/K (for T > 500 °C) of temp. reading per K (deviation to $T_a = 23$ °C)
Dimensions	M30 x 210 mm (without plug)

Energy

Target diameter [mm]

95%	21.4	16.9	12.5	8	17.8	28	37	47	57	67	77	175	273	371	469
90%	21.4	16.6	11.8	7	16.5	26	35	45	54	64	73	168	263	357	452

Target distance [mm]

0 100 200 300 400 500 600 700 800 900 1000 2000 3000 4000 5000 ∞

PK 31 AF 1	
Temperature range	500 - 2500 °C
Sensor	Si
Spectral sensitivity	0.78 - 1.06 μm
Focus distance	1500 mm
Target spot diameter	8 mm
Analogue output OUT2	0(4) - 20 mA linear, switchable, scalable (≥ 100 K)
Resolution current output	0.2 K + 0.03 % of selected range
Resolution temp. reading	1 K
Response time t_{90}	≤ 2 ms (for $T > 900$ °C)
Repeatability	1 K
Measurement uncertainty	0.2 % of temp. reading [°C] plus 2.5 K (at $\epsilon = 1.0$ and $T_a = 23$ °C)
Temperature coefficient	0.07 %/K of temp. reading / K (deviation to $T_a = 23$ °C)
Dimensions	M30 x 210 mm (without plug)

Energy	Target diameter [mm]														
95 %	15	14.5	14.1	13.6	13.2	12.7	10.4	8.1	15.8	24	31	39	47	54	62
90 %	15	14.5	14	13.6	13.1	12.6	10.2	7.8	15.4	23	31	38	46	53	61

Target distance [mm]

0 100 200 300 400 500 1000 1500 2000 2500 3000 3500 4000 4500 5000 ∞

PK 41 AF 1	
Temperature range	300 - 1300 °C
Sensor	Thermopile
Spectral sensitivity	4.6 - 4.9 μm
Focus distance	400 mm
Target spot diameter	11 mm
Analogue output OUT2	0(4) - 20 mA linear, switchable, scalable (≥ 50 K)
Resolution current output	0.2 K + 0.03 % of selected range
Resolution temp. reading	1 K
Response time t_{90}	≤ 90 ms
Repeatability [#]	2 K
Measurement uncertainty [#]	0.5 % of temp. reading [$^{\circ}\text{C}$] plus 2.5 K
Temperature coefficient [#]	0.04 %/K of temp. reading / K
Dimensions	M30 x 210 mm (without plug)

Energy	Target diameter [mm]															
95 %	18.2	17.7	17.1	16.6	16	25	33	42	50	59	67	153	238	324	409	
90 %	18.2	16.4	14.6	12.8	11	18	26	33	40	48	55	128	201	274	347	

Target distance [mm]

[#] Data applies to a thermally stabilised state.

PK 42 AF 1	
Temperature range	500 - 2500 °C
Sensor	Thermopile
Spectral sensitivity	4.6 - 4.9 μm
Focus distance	400 mm
Target spot diameter	7 mm
Analogue output OUT2	0(4) - 20 mA linear, switchable, scalable (≥ 50 K)
Resolution current output	0.2 K + 0.03 % of selected range
Resolution temp. reading	1 K
Response time t_{90}	≤ 60 ms
Repeatability [#]	4 K
Measurement uncertainty [#]	1.0 % of temp. reading [$^{\circ}\text{C}$]
Temperature coefficient [#]	0.04 %/K of temp. reading / K
Dimensions	M30 x 210 mm (without plug)

Energy

Target diameter [mm]

95% 18.2 16.7 15.1 13.6 12 20 27 35 42 50 57 133 208 284 359

90% 18.2 15.4 12.6 9.8 7 13 20 26 32 39 45 108 171 234 297

Target distance [mm]

0 100 200 300 400 500 600 700 800 900 1000 2000 3000 4000 5000 ∞

[#] Data applies to a thermally stabilised state.

PK 51 AF 1	
Temperature range	400 - 1400 °C
Sensor	Thermopile
Spectral sensitivity	3.8 - 4.0 μm
Focus distance	400 mm
Target spot diameter	11 mm
Analogue output OUT2	0(4) - 20 mA linear, switchable, scalable (≥ 50 K)
Resolution current output	0.2 K + 0.03 % of selected range
Resolution temp. reading	1 K
Response time t_{90}	≤ 90 ms
Repeatability [#]	2 K
Measurement uncertainty [#]	1.0 % of temp. reading [$^{\circ}\text{C}$]
Temperature coefficient [#]	0.04 %/K of temp. reading / K
Dimensions	M30 x 200 mm (without plug)

Energy	Target diameter [mm]															
95 %	18.2	17.7	17.1	16.6	16	25	33	42	50	59	67	153	238	324	409	
90 %	18.2	16.4	14.6	12.8	11	18	26	33	40	48	55	128	201	274	347	

Target distance [mm]

[#] Data applies to a thermally stabilised state.

PK 52 AF 1	
Temperature range	500 - 2000 °C
Sensor	Thermopile
Spectral sensitivity	3.8 - 4.0 μm
Focus distance	400 mm
Target spot diameter	7 mm
Analogue output OUT2	0(4) - 20 mA linear, switchable, scalable (≥ 50 K)
Resolution current output	0.2 K + 0.03 % of selected range
Resolution temp. reading	1 K
Response time t_{90}	≤ 60 ms
Repeatability [#]	4 K
Measurement uncertainty [#]	1.0 % of temp. reading [$^{\circ}\text{C}$]
Temperature coefficient [#]	0.04 %/K of temp. reading / K
Dimensions	M30 x 200 mm (without plug)

Energy	Target diameter [mm]															
95 %	18.2	16.7	15.1	13.6	12	20	27	35	42	50	57	133	208	284	359	
90 %	18.2	15.4	12.6	9.8	7	13	20	26	32	39	45	108	171	234	297	

Target distance [mm]

[#] Data applies to a thermally stabilised state.

PK 72 AF 1	
Temperature range	400 - 2000 °C
Sensor	Thermopile
Spectral sensitivity	CO ₂ -Bande
Focus distance	400 mm
Target spot diameter	7 mm
Analogue output OUT2	0(4) - 20 mA linear, switchable, scalable (≥ 50 K)
Resolution current output	0.2 K + 0.03 % of selected range
Resolution temp. reading	1 K
Response time t_{90}	≤ 60 ms
Repeatability [#]	2 K
Measurement uncertainty [#]	1.0 % of temp. reading [°C]
Temperature coefficient [#]	0.04 %/K of temp. reading / K
Dimensions	M30 x 200 mm (without plug)

EN

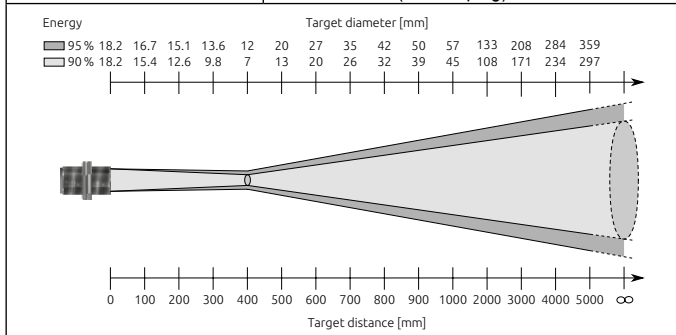

[#] Data applies to a thermally stabilised state.

PKF 26 AF 1	
Temperature range	300 - 1600 °C
Sensor	InGaAs
Spectral sensitivity	1.0 - 1.7 μm
Focus distance	200 mm ... ∞ (adjustable)
Distance ratio	180:1 (measuring head PA 41.01)
Analogue output OUT2	0(4) - 20 mA linear, switchable, scalable (≥ 50 K)
Resolution current output	0.2 K + 0.03 % of selected range
Resolution temp. reading	1 K
Response time t_{90}	≤ 2 ms (for $T > 600$ °C)
Repeatability	2 K
Measurement uncertainty	0.3 % of temp. reading [°C] plus 2.5 K (at $\epsilon = 1.0$ and $T_a = 23$ °C)
Temperature coefficient	0.07 %/K of temp. reading / K (deviation to $T_a = 23$ °C)
Ambient temperature measuring head	fiber optic metal 0 - 250 °C
Dimensions	M30 x 200 mm (electronics without plug) M30 x 67...86 mm (fiber optic measuring head)

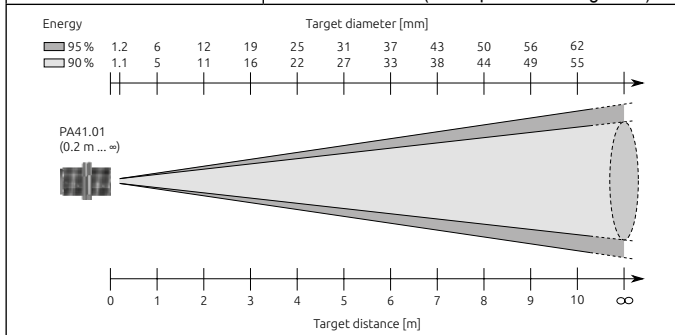

PKF 26 AF 2	
Temperature range	300 - 1600 °C
Sensor	InGaAs
Spectral sensitivity	1.0 - 1.7 μm
Focus distance	1500 mm
Target spot diameter	7.2 mm (measuring head PKS 21.01)
Analogue output OUT2	0(4) - 20 mA linear, switchable, scalable (≥ 50 K)
Resolution current output	0.2 K + 0.03 % of selected range
Resolution temp. reading	1 K
Response time t_{90}	≤ 2 ms (for $T > 600$ °C)
Repeatability	2 K
Measurement uncertainty	0.3 % of temp. reading [°C] plus 2.5 K (at $\epsilon = 1.0$ and $T_a = 23$ °C)
Temperature coefficient	0.07 %/K of temp. reading / K (deviation to $T_a = 23$ °C)
Ambient temperature measuring head	fiber optic metal 0 - 250 °C
Dimensions	M30 x 200 mm (electronics without plug) M30 x 67...86 mm (fiber optic measuring head)
<p>Energy Target diameter [mm]</p> <p>95% 21.4 20.5 19.6 18.7 17.8 16.9 12.5 8 18 28 37 47 57 67 77 90% 21.4 20.5 19.5 18.6 17.6 16.7 11.9 7.2 17 26 36 45 55 64 74</p> <p>PKS21.01 (1.5 m)</p> <p>Target distance [m]</p>	

PKF 26 AF 3	
Temperature range	300 - 1600 °C
Sensor	InGaAs
Spectral sensitivity	1.0 - 1.7 μm
Focus distance	120 mm ... ∞ (adjustable)
Distance ratio	100:1 (measuring head PA 41.05)
Analogue output OUT2	0(4) - 20 mA linear, switchable, scalable (≥ 50 K)
Resolution current output	0.2 K + 0.03 % of selected range
Resolution temp. reading	1 K
Response time t_{90}	≤ 2 ms (for $T > 600$ °C)
Repeatability	2 K
Measurement uncertainty	0.3 % of temp. reading [°C] plus 2.5 K (at $\epsilon = 1.0$ and $T_a = 23$ °C)
Temperature coefficient	0.07 %/K of temp. reading / K (deviation to $T_a = 23$ °C)
Ambient temperature measuring head	fiber optic metal 0 - 250 °C
Dimensions	M30 x 200 mm (electronics without plug) M30 x 67...86 mm (fiber optic measuring head)

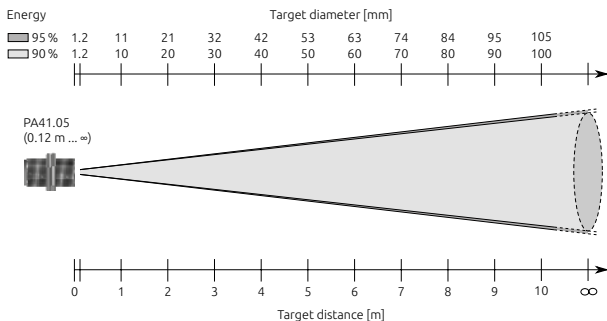

PKF 26 AF 4	
Temperature range	300 - 1600 °C
Sensor	InGaAs
Spectral sensitivity	1.0 - 1.7 μm
Focus distance	33 - 45 mm
Distance ratio	50:1 (measuring head PZ 41.18)
Analogue output OUT2	0(4) - 20 mA linear, switchable, scalable (≥ 50 K)
Resolution current output	0.2 K + 0.03 % of selected range
Resolution temp. reading	1 K
Response time t_{90}	≤ 2 ms (for $T > 600$ °C)
Repeatability	2 K
Measurement uncertainty	0.3 % of temp. reading [°C] plus 2.5 K (at $\epsilon = 1.0$ and $T_a = 23$ °C)
Temperature coefficient	0.07 %/K of temp. reading / K (deviation to $T_a = 23$ °C)
Ambient temperature measuring head	fiber optic metal 0 - 250 °C
Dimensions	M30 x 200 mm (electronics without plug) M30 x 67...86 mm (fiber optic measuring head)

EN

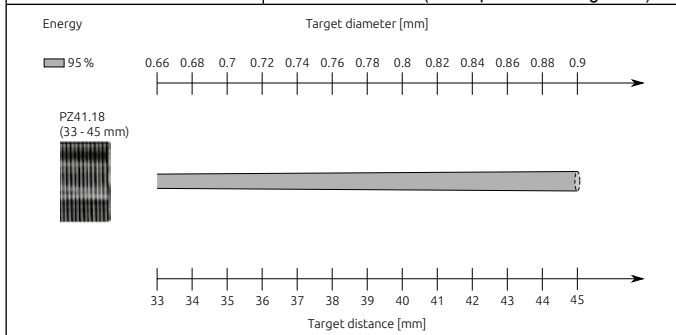

PKF 36 AF 1	
Temperature range	550 - 2500 °C
Sensor	Si
Spectral sensitivity	0.78 - 1.06 μm
Focus distance	200 mm ... ∞ (adjustable)
Distance ratio	190:1 (measuring head PA 41.01)
Analogue output OUT2	0(4) - 20 mA linear, switchable, scalable (≥ 50 K)
Resolution current output	0.2 K + 0.03 % of selected range
Resolution temp. reading	1 K
Response time t_{90}	≤ 2 ms (for T > 900 °C)
Repeatability	2 K
Measurement uncertainty	0.3 % of temp. reading [°C] plus 2.5 K (at $\epsilon = 1.0$ and $T_a = 23$ °C)
Temperature coefficient	0.07 %/K of temp. reading / K (deviation to $T_a = 23$ °C)
Ambient temperature measuring head	fiber optic metal 0 - 250 °C
Dimensions	M30 x 200 mm (electronics without plug) M30 x 67...86 mm (fiber optic measuring head)

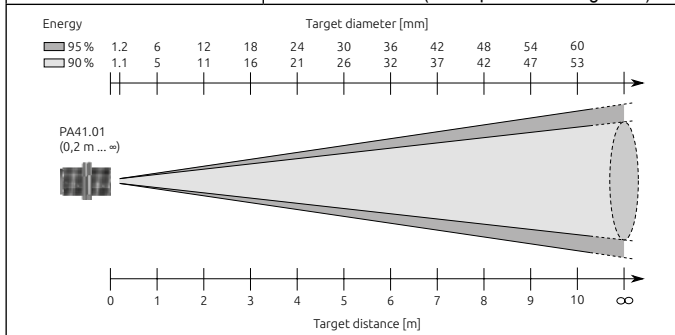

PKF 36 AF 2	
Temperature range	550 - 2500 °C
Sensor	Si
Spectral sensitivity	0.78 - 1.06 μm
Focus distance	1080 mm
Target spot diameter	6.9 mm (measuring head PKS 21.01)
Analogue output OUT2	0(4) - 20 mA linear, switchable, scalable (≥ 50 K)
Resolution current output	0.2 K + 0.03 % of selected range
Resolution temp. reading	1 K
Response time t_{90}	≤ 2 ms (for T > 900 °C)
Repeatability	2 K
Measurement uncertainty	0.3 % of temp. reading [°C] plus 2.5 K (at $\epsilon = 1.0$ and $T_a = 23$ °C)
Temperature coefficient	0.07 %/K of temp. reading / K (deviation to $T_a = 23$ °C)
Ambient temperature measuring head	fiber optic metal 0 - 250 °C
Dimensions	M30 x 200 mm (electronics without plug) M30 x 67...86 mm (fiber optic measuring head)

Energy	Target diameter [mm]													
95 %	21.4	20.0	18.6	17.2	15.8	14.4	7.6	30	43	55	68	81	94	106
90 %	21.4	19.9	18.5	17.0	15.5	14.1	6.9	29	41	54	66	79	91	104

PKS21.01
(1.08 m)

Target distance [m]

Target diameter [mm]

PKF 36 AF 3	
Temperature range	550 - 2500 °C
Sensor	Si
Spectral sensitivity	0.78 - 1.06 μm
Focus distance	120 mm ... ∞ (adjustable)
Distance ratio	100:1 (measuring head PA 41.05)
Analogue output OUT2	0(4) - 20 mA linear, switchable, scalable (≥ 50 K)
Resolution current output	0.2 K + 0.03 % of selected range
Resolution temp. reading	1 K
Response time t_{90}	≤ 2 ms (for $T > 900$ °C)
Repeatability	2 K
Measurement uncertainty	0.3 % of temp. reading [°C] plus 2.5 K (at $\epsilon = 1.0$ and $T_a = 23$ °C)
Temperature coefficient	0.07 %/K of temp. reading / K (deviation to $T_a = 23$ °C)
Ambient temperature measuring head	fiber optic metal 0 - 250 °C
Dimensions	M30 x 200 mm (electronics without plug) M30 x 67...86 mm (fiber optic measuring head)

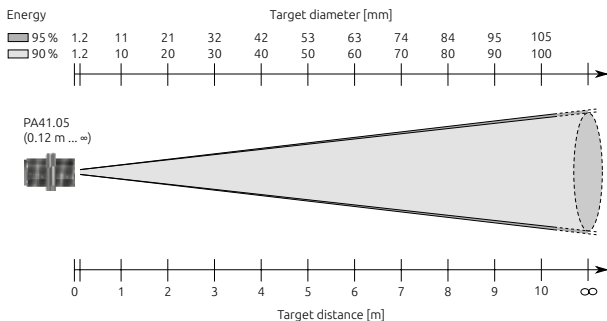

PKF 36 AF 4	
Temperature range	550 - 2500 °C
Sensor	Si
Spectral sensitivity	0.78 - 1.06 μm
Focus distance	33 - 45 mm
Distance ratio	50:1 (measuring head PZ 41.18)
Analogue output OUT2	0(4) - 20 mA linear, switchable, scalable (≥ 50 K)
Resolution current output	0.2 K + 0.03 % of selected range
Resolution temp. reading	1 K
Response time t_{90}	≤ 2 ms (for $T > 900$ °C)
Repeatability	2 K
Measurement uncertainty	0.3 % of temp. reading [°C] plus 2.5 K (at $\epsilon = 1.0$ and $T_a = 23$ °C)
Temperature coefficient	0.07 %/K of temp. reading / K (deviation to $T_a = 23$ °C)
Ambient temperature measuring head	fiber optic metal 0 - 250 °C
Dimensions	M30 x 200 mm (electronics without plug) M30 x 67...86 mm (fiber optic measuring head)

EN

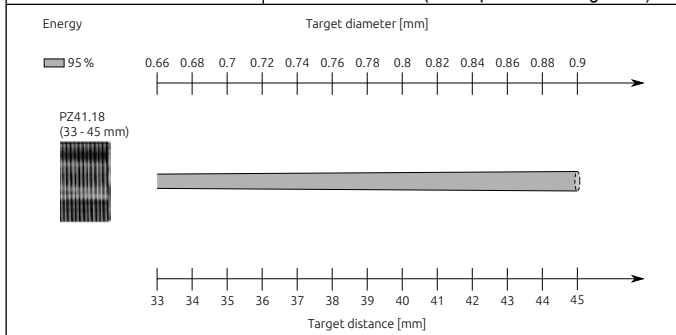

Data applies to a thermally stabilised state.

PKL 11 AF 1	
Temperature range	0 - 1000 °C
Sensor	Thermopile
Spectral sensitivity	8 - 14 µm
Focus distance	295 mm
Target spot diameter	9 mm
Analogue output OUT2	0(4) - 20 mA linear, switchable, scalable (≥ 50 K)
Resolution current output	0.2 K + 0.03 % of selected range
Resolution temp. reading	0.1 K (for $T < 200$ °C), 1 K (for $T \geq 200$ °C)
Response time t_{90}	≤ 60 ms
Repeatability [#]	1 K
Measurement uncertainty [#]	0.75 % of temp. reading [°C] plus 2.0 K
Temperature coefficient [#]	0.1 K/K (for $T < 250$ °C), 0.04 %/K (for $T > 250$ °C) of temp. reading / K
Dimensions	M30 x 200 mm (without plug)

Energy	Target diameter [mm]								
LED	5	6.8	8.6	10.3	12	16.6	20.9	25.3	
90 %	21.2	18.1	15.0	11.9	9	17.2	24.9	32.5	

Target distance [mm]

[#] Data applies to a thermally stabilised state.

PKL 11 AF 2	
Temperature range	0 - 1000 °C
Sensor	Thermopile
Spectral sensitivity	8 - 14 µm
Focus distance	89 mm
Target spot diameter	3.2 mm
Analogue output OUT2	0(4) - 20 mA linear, switchable, scalable (≥ 50 K)
Resolution current output	0.2 K + 0.03 % of selected range
Resolution temp. reading	0.1 K (for $T < 200$ °C), 1 K (for $T \geq 200$ °C)
Response time t_{90}	≤ 60 ms
Repeatability [#]	1 K
Measurement uncertainty [#]	0.75 % of temp. reading [°C] plus 2.0 K
Temperature coefficient [#]	0.1 K/K (for $T < 250$ °C), 0.04 %/K (for $T > 250$ °C) of temp. reading / K
Dimensions	M30 x 200 mm (without plug)

Energy	Target diameter [mm]								
LED	5	4.6	4.1	4	7.1	10.2	13.2	16.2	
90 %	21.2	15.1	9.1	3.2	11.7	19.9	28.1	36.4	

Target distance [mm]

[#] Data applies to a thermally stabilised state.

PKL 28 AF 1	
Temperature range	250 - 1600 °C
Sensor	InGaAs
Spectral sensitivity	1.0 - 1.7 μm
Focus distance	210 mm
Target spot diameter	1.4 mm
Analogue output OUT2	0(4) - 20 mA linear, switchable, scalable (≥ 50 K)
Resolution current output	0.2 K + 0.03 % of selected range
Resolution temp. reading	1 K
Response time t_{90}	≤ 2 ms (for $T > 600$ °C)
Repeatability	1 K
Measurement uncertainty	0.3 % of temp. reading [°C] plus 2.5 K (at $\epsilon = 1.0$ and $T_a = 23$ °C)
Temperature coefficient	0.07 %/K of temp. reading / K (deviation to $T_a = 23$ °C)
Dimensions	M30 x 235 mm (without plug)

Energy	Target diameter [mm]														
LED	5	4.5	4.0	3.6	3.1	2.6	2.1	3.3	4.5	5.7	6.8	8	9.2	10.4	11.5
95%	18.2	15.4	12.6	9.8	7	4.2	1.4	4.7	7.9	11.2	14.5	17.8	21	24.3	27.6

Target distance [mm]

PKL 28 AF 2	
Temperature range	250 - 1600 °C
Sensor	InGaAs
Spectral sensitivity	1.0 - 1.7 μm
Focus distance	1000 mm
Target spot diameter	6.7 mm
Analogue output OUT2	0(4) - 20 mA linear, switchable, scalable (≥ 50 K)
Resolution current output	0.2 K + 0.03 % of selected range
Resolution temp. reading	1 K
Response time t_{90}	≤ 2 ms (for $T > 600$ °C)
Repeatability	1 K
Measurement uncertainty	0.3 % of temp. reading [°C] plus 2.5 K (at $\epsilon = 1.0$ and $T_a = 23$ °C)
Temperature coefficient	0.07 %/K of temp. reading / K (deviation to $T_a = 23$ °C)
Dimensions	M30 x 235 mm (without plug)

EN

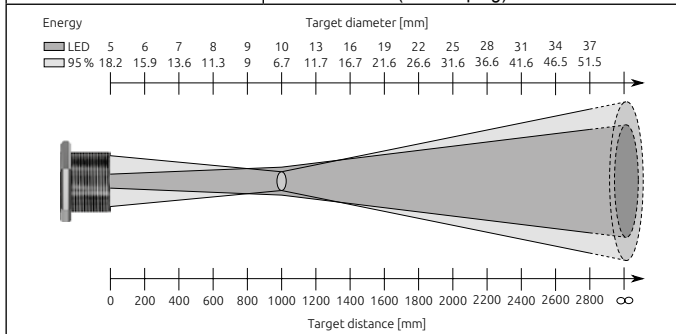

PKL 29 AF 1	
Temperature range	180 - 1200 °C
Sensor	ext. InGaAs
Spectral sensitivity	1.8 - 2.2 μm
Focus distance	290 mm
Target spot diameter	6.2 mm
Analogue output OUT2	0(4) - 20 mA linear, switchable, scalable (≥ 50 K)
Resolution current output	0.2 K + 0.03 % of selected range
Resolution temp. reading	1 K
Response time t_{98}	≤ 2 ms (for $T > 300$ °C) ≤ 10 ms (for $T > 250$ °C) ≤ 25 ms (for $T > 180$ °C)
Repeatability	1 K
Measurement uncertainty	0.3 % of temp. reading [°C] plus 4.0 K (at $\epsilon = 1.0$ and $T_a = 23$ °C)
Temperature coefficient	0.25 K/K (for $T < 500$ °C), 0.05 %/K (for $T > 500$ °C) of temp. reading per K (deviation to $T_a = 23$ °C)
Dimensions	M30 x 235 mm (without plug)

Energy	Target diameter [mm]														
LED	5	5.3	5.5	5.8	6.1	6.3	6.6	6.9	7.2	8.3	9.7	11.2	12.7	14.1	15.6
95%	18.2	16.8	15.3	13.9	12.4	11	9.5	8.1	6.2	8.3	11.2	14.2	17.1	20.1	23

Target distance [mm]

0 35 70 105 140 175 210 245 290 315 350 385 420 455 490 ∞

PKL 38 AF 1	
Temperature range	500 - 2500 °C
Sensor	Si
Spectral sensitivity	0.78 - 1.06 μm
Focus distance	210 mm
Target spot diameter	1.2 mm
Analogue output OUT2	0(4) - 20 mA linear, switchable, scalable (≥ 50 K)
Resolution current output	0.2 K + 0.03 % of selected range
Resolution temp. reading	1 K
Response time t_{90}	≤ 2 ms (for $T > 900$ °C)
Repeatability	1 K
Measurement uncertainty	0.2 % of temp. reading [°C] plus 2.5 K (at $\epsilon = 1.0$ and $T_a = 23$ °C)
Temperature coefficient	0.07 %/K of temp. reading / K (deviation to $T_a = 23$ °C)
Dimensions	M30 x 235 mm (without plug)

EN

Energy

Target diameter [mm]

LED	5	4.5	4.0	3.6	3.1	2.6	2.1	3.3	4.5	5.7	6.8	8	9.2	10.4	11.5
95%	18.2	15.4	12.5	9.7	6.9	4	1.2	4.5	7.7	10.9	14.1	17.4	20.6	23.8	27.0

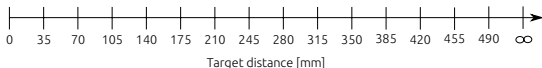
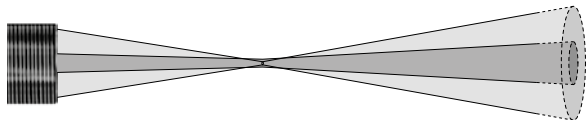

PKL 38 AF 2	
Temperature range	500 - 2500 °C
Sensor	Si
Spectral sensitivity	0.78 - 1.06 μm
Focus distance	1000 mm
Target spot diameter	5.6 mm
Analogue output OUT2	0(4) - 20 mA linear, switchable, scalable (≥ 50 K)
Resolution current output	0.2 K + 0.03 % of selected range
Resolution temp. reading	1 K
Response time t_{90}	≤ 2 ms (for $T > 900$ °C)
Repeatability	1 K
Measurement uncertainty	0.2 % of temp. reading [°C] plus 2.5 K (at $\epsilon = 1.0$ and $T_a = 23$ °C)
Temperature coefficient	0.07 %/K of temp. reading / K (deviation to $T_a = 23$ °C)
Dimensions	M30 x 235 mm (without plug)

Energy

Target diameter [mm]	5	6	7	8	9	10	13	16	19	22	25	28	31	34	37
LED	5	6	7	8	9	10	13	16	19	22	25	28	31	34	37
95%	18.2	15.7	13.2	10.6	8.1	5.6	10.4	15.1	19.9	24.6	29.4	34.2	38.9	43.7	48.4

Target diameter [mm]

Target distance [mm]

22 Factory settings

	Parameter	Factory settings			User settings
		PK 11 AF 1+AF 2	PK 12 AF 1	PK 14 AF 1	
Ro	Ra ₋	0 °C	-30 °C	0 °C	
	Ra ₋	1000 °C	300 °C	500 °C	
	RaD4	4 - 20 mA	4 - 20 mA	4 - 20 mA	
do	doSP	250 °C	50 °C	125 °C	
	doRP	230 °C	45 °C	115 °C	
	doFn	no	no	no	
	doDS	oFF	oFF	oFF	
	doDr	oFF	oFF	oFF	
EF	EPS	100.0			
	PhLd	oFF			
	dRP	oFF			
	di SP.	on			
	Unit	°C			

EN

	Parameter	Factory settings			User settings
		PK 18 AF 1	PK 18 AF 2	PK 21 AF 1	
Ro	Ra _	0 °C	0 °C	250 °C	
	Ra -	500 °C	400 °C	1600 °C	
	Ra04	4 - 20 mA	4 - 20 mA	4 - 20 mA	
do	daSP	250 °C	250 °C	580 °C	
	darP	230 °C	230 °C	560 °C	
	daFn	no	no	no	
	dadS	oFF	oFF	oFF	
	dadr	oFF	oFF	oFF	
EF	EPS	100.0			
	PhLd	oFF			
	dAP	oFF			
	di SP.	on			
	Unit	°C			

	Parameter	Factory settings			User settings
		PK 24 AF 1	PK 25 AF 1	PK 29 AF 1	
Ro	Ra _	250 °C	75 °C	150 °C	
	Ra -	1600 °C	650 °C	800 °C	
	Ra04	4 - 20 mA	4 - 20 mA	4 - 20 mA	
do	daSP	580 °C	220 °C	320 °C	
	darP	560 °C	210 °C	300 °C	
	daFn	no	no	no	
	dadS	oFF	oFF	oFF	
	dadr	oFF	oFF	oFF	
EF	EPS	100.0			
	PhLd	oFF			
	dAP	oFF			
	di SP.	on			
	Unit	°C			

	Parameter	Factory settings			User settings
		PK 31 AF 1	PK 41 AF 1	PK 42 AF 1	
Ro	Ra ₋	500 °C	300 °C	500 °C	
	Ra ₋	2500 °C	1300 °C	2500 °C	
	Ra04	4 - 20 mA	4 - 20 mA	4 - 20 mA	
do	daSP	1000 °C	550 °C	1000 °C	
	darP	960 °C	530 °C	960 °C	
	daFn	no	no	no	
	dadS	oFF	oFF	oFF	
	dadr	oFF	oFF	oFF	
EF	EPS	100.0			
	PhLd	oFF			
	dAP	oFF			
	di SP.	on			
	Unit	°C			

	Parameter	Factory settings			User settings
		PK 51 AF 1	PK 52 AF 1	PK 72 AF 1	
Ro	Ra ₋	400 °C	500 °C	400 °C	
	Ra ₋	1400 °C	2000 °C	2000 °C	
	Ra04	4 - 20 mA	4 - 20 mA	4 - 20 mA	
do	daSP	650 °C	900 °C	1000 °C	
	darP	630 °C	850 °C	960 °C	
	daFn	no	no	no	
	dadS	oFF	oFF	oFF	
	dadr	oFF	oFF	oFF	
EF	EPS	100.0			
	PhLd	oFF			
	dAP	oFF			
	di SP.	on			
	Unit	°C			

EN

	Parameter	Factory settings			User settings
		PKF 26 AF 1, AF 2 + AF 3	PKF 36 AF 1, AF 2 + AF 3	PKL 11 AF 1 + AF 2	
Ro	Ra _	300 °C	550 °C	0 °C	
	Ra -	1600 °C	2500 °C	1000 °C	
	Ra04	4 - 20 mA	4 - 20 mA	4 - 20 mA	
do	daSP	620 °C	1040 °C	250 °C	
	darP	600 °C	1000 °C	230 °C	
	daFn	no	no	no	
	dadS	oFF	oFF	oFF	
	dadr	oFF	oFF	oFF	
EF	EPS	100.0			
	PhLd	oFF			
	dAP	oFF			
	di SP.	on			
	Unit	°C			

	Parameter	Factory settings			User settings
		PKL 28 AF 1 + AF 2	PKL 29 AF 1	PKL 38 AF 1 + AF 2	
Ro	Ra ₋	250 °C	180 °C	500 °C	
	Ra ₋	1600 °C	1200 °C	2500 °C	
	Ra04	4 - 20 mA	4 - 20 mA	4 - 20 mA	
do	daSP	580 °C	410 °C	1000 °C	
	darP	560 °C	440 °C	960 °C	
	daFn	no	no	no	
	dodS	oFF	oFF	oFF	
	dodr	oFF	oFF	oFF	
EF	EPS	100.0			
	PhLd	oFF			
	dAP	oFF			
	di SP.	on			
	Unit	°C			

EN

More information at www.keller.de/its

23 Copyright

The device software contains portions of the avr-libc library.

Portions of avr-libc are Copyright (c) 1999-2007

Keith Gudger,
Bjoern Haase,
Steinar Haugen,
Peter Jansen,
Reinhard Jessich,
Magnus Johansson,
Artur Lipowski,
Marek Michalkiewicz,

Colin O'Flynn,
Bob Paddock,
Reiner Patommel,
Michael Rickman,
Theodore A. Roth,
Juergen Schilling,
Philip Soeberg,
Anatoly Sokolov,

Nils Kristian Strom,
Michael Stumpf,
Stefan Swanepoel,
Eric B. Weddington,
Joerg Wunsch,
Dmitry Xmelkov,
The Regents of the
University of California.

All rights reserved.

Redistribution and use in source and binary forms, with or without modification, are permitted provided that the following conditions are met:

- * Redistributions of source code must retain the above copyright notice, this list of conditions and the following disclaimer.
- * Redistributions in binary form must reproduce the above copyright notice, this list of conditions and the following disclaimer in the documentation and/or other materials provided with the distribution.
- * Neither the name of the copyright holders nor the names of contributors may be used to endorse or promote products derived from this software without specific prior written permission.

THIS SOFTWARE IS PROVIDED BY THE COPYRIGHT HOLDERS AND CONTRIBUTORS „AS IS“ AND ANY EXPRESS OR IMPLIED WARRANTIES, INCLUDING, BUT NOT LIMITED TO, THE IMPLIED WARRANTIES OF MERCHANTABILITY AND FITNESS FOR A PARTICULAR PURPOSE ARE DISCLAIMED. IN NO EVENT SHALL THE COPYRIGHT OWNER OR CONTRIBUTORS BE LIABLE FOR ANY DIRECT, INDIRECT, INCIDENTAL, SPECIAL, EXEMPLARY, OR CONSEQUENTIAL DAMAGES (INCLUDING, BUT NOT LIMITED TO, PROCUREMENT OF SUBSTITUTE GOODS OR SERVICES; LOSS OF USE, DATA, OR PROFITS; OR BUSINESS INTERRUPTION) HOWEVER CAUSED AND ON ANY THEORY OF LIABILITY, WHETHER IN CONTRACT, STRICT LIABILITY, OR TORT (INCLUDING NEGLIGENCE OR OTHERWISE) ARISING IN ANY WAY OUT OF THE USE OF THIS SOFTWARE, EVEN IF ADVISED OF THE POSSIBILITY OF SUCH DAMAGE.

Copyright prohibits the reproduction or distribution of this instruction manual, including text, photographs or images contained herein, in whole or in part, for any purpose whatsoever, without prior consent of the author. This applies to any form of mechanical or electronic reproduction as well as to electronic transmission in any form through any medium.

Please note:

Unless otherwise stated in this instruction manual, the instruments described herein are subject to change without prior notice, particularly modifications for the sake of technological advancement.

© 2018 KELLER HCW GmbH
Carl-Keller-Straße 2-10
D-49479 Ibbenbüren-Laggenbeck
Germany
www.keller.de/its

