

# Profibus DP PZ - AF 4xx

Mat. No.: 515 437 (English) 04/2018

Copyright prohibits the reproduction or distribution of this instruction-manual, including text, photographs or images contained herein, in whole or in part, for any purpose whatsoever, without prior consent of the author. This applies to any form of mechanical or electronic reproduction as well as to electronic transmission in any form through any medium.

Please note:

Unless otherwise stated in this instruction manual, technical alterations, particularly those serving technical progress, may be made without notice.

Warranty can only be assumed if the instrument has not been tampered with and is returned intact to KELLER HCW GmbH for repair and / or service.

© 2009 **KELLER HCW GmbH**  
Carl-Keller-Strasse 2 – 10  
D-49479 Ibbenbüren - Laggenbeck  
Germany  
[www.keller.de/its](http://www.keller.de/its)

## Safety Instructions

### General Instructions

The measuring head is designed according to state-of-the-art technology, complies with commonly accepted safety rules and is highly reliable. Improper handling however, may cause damage to the measuring head or to other goods involved.

All persons involved with operation and maintenance of the measuring head must first read the instruction manual.

The measuring head may only be used when it is in good order and condition and under the observance of all local safety regulations. In case the measuring head malfunctions, it is imperative that operation be ceased immediately.

The common regulations for the prevention of accidents must be observed.

## Intended Use

The measuring head is exclusively built for non-contact measuring of temperatures. Any other use is not intended. The manufacturer is not liable for any damages resulting from such unintended use; in this case the risk is solely borne by the user.

Only persons who are familiar with the use of the measuring head and who have been informed of possible dangers, are allowed to operate and maintain them.

**Arbitrary alterations to the measuring head or operation of the measuring head beyond the permitted operating conditions exclude the liability of the manufacturer for any damages resulting thereof.**

## Contents

<b>1</b>	<b>General Description .....</b>	<b>1</b>
<b>2</b>	<b>Installation .....</b>	<b>3</b>
<b>3</b>	<b>Handling, Adjustment and Focus.....</b>	<b>3</b>
3.1	Pyrometer with through-the-lens sighting.....	3
3.2	Pyrometer with fibre optics.....	4
3.3	Pyrometer with laser spot light.....	5
3.4	Focussing .....	5
3.5	General Laser Use and Precautions .....	6
3.5.1	Laser Influence on Temperature Reading .....	6
3.5.2	Laser Radiation Hazard .....	6
3.5.3	Laser Power.....	6
3.5.4	Laser Warning Label.....	7
3.5.5	Laser warning label must be visible! .....	7
3.6	Smoothing Function .....	8
3.7	Peak-Picker .....	8
<b>4</b>	<b>Theory of Non-Contact Temperature Measurements .....</b>	<b>10</b>
4.1	Advantages of Non-Contact Temperature Measurements	10
4.2	Measurements at Black Bodies (Cavity Radiators) .....	10
4.3	Measurements of Real Radiators.....	11
4.4	Emissivity Coefficient Table PZ 10.....	12
4.5	Emissivity Coefficient Table PZ 20 – PZ 41 .....	13
<b>5</b>	<b>PROFIBUS DP Interface.....</b>	<b>14</b>
5.1	PROFIBUS Technology .....	14
5.2	Cyclical Master-Slave Communication.....	14
5.3	Cable installation .....	15
5.4	Termination of the Profibus-Cable .....	16
5.5	Device address .....	18
5.6	GSE File .....	18
5.7	Parameterization.....	19
5.8	Configuration .....	20
5.9	Diagnostics .....	22
5.10	Acyclic Data Exchange.....	23
5.11	Organisation of CellaTemp PZ Data Sets.....	23
<b>6</b>	<b>Summary of Data Sets .....</b>	<b>26</b>
6.1	Data Sets Used:.....	29
6.2	Layout of the configuration telegram.....	30
6.3	The GSE-file .....	32
<b>7</b>	<b>Integration into the Simatic S7.....</b>	<b>36</b>
7.1	Integrating the GSE File into the Simatic S7 .....	36
7.2	Integrating CellaTemp PZ into a S7 Master System .....	37

7.3	Configuration of Modular CellaTemp PZ.....	38
7.4	Parameters in Siematic STEP 7 .....	39
<b>8</b>	<b>Maintenance .....</b>	<b>41</b>
8.1	Cleaning the pyrometer lens .....	41
<b>9</b>	<b>Technical Data PZ 10 .....</b>	<b>42</b>
9.1	Target Diagram PZ 10 .....	43
<b>10</b>	<b>Technical Data PZ 15 .....</b>	<b>44</b>
10.1	Target Diagram PZ 15 .....	45
<b>11</b>	<b>Technical Data PZ 20 .....</b>	<b>46</b>
11.1	Target Diagram PZ 20 .....	47
<b>12</b>	<b>Technical Data PZ 30 .....</b>	<b>48</b>
12.1	Target Diagram PZ 30 .....	49
<b>13</b>	<b>Technical Data PZ 35 .....</b>	<b>50</b>
13.1	Target Diagram PZ 35 .....	51
<b>14</b>	<b>Technical Data PZ 27 AF 410.....</b>	<b>52</b>
14.1	Target diagram PZ 27 AF 410 .....	53
<b>15</b>	<b>Technical Data PZ 27 AF 421 - 423.....</b>	<b>54</b>
15.1	Field of View Diagrams for PA 29 AF 421 – 423.....	55
<b>16</b>	<b>Technical Data PZ 21 / 31 .....</b>	<b>57</b>
16.1	Target Diagram PZ 21 / 31 .....	58
<b>17</b>	<b>Technical Data PZ 40 .....</b>	<b>59</b>
17.1	Target Diagram PZ 40 .....	60
<b>18</b>	<b>Technical Data PZ 41 .....</b>	<b>61</b>
18.1	Target Diagram PZ 41 .....	62
<b>19</b>	<b>Technical Data Technical Data PZ 50 .....</b>	<b>63</b>
19.1	Target diagram PZ 50.....	64
<b>20</b>	<b>Technical Data PZ 60 .....</b>	<b>65</b>
20.1	Target diagram PZ 60.....	66
<b>21</b>	<b>Dimensional Drawings.....</b>	<b>67</b>
<b>22</b>	<b>Terminal Pin Assignment .....</b>	<b>69</b>
22.1	Recommendation of mounting.....	69
<b>23</b>	<b>Glossary.....</b>	<b>70</b>
<b>24</b>	<b>Shipping, Packaging and Disposal .....</b>	<b>71</b>



## 1 General Description

The PZ 1x - PZ 5x series provides five efficient, microprocessor-controlled pyrometers for non-contact temperature measurements.

The field of application of the radiation pyrometer PZ 10 includes the measurement of materials such as synthetic materials, rubber, textiles, paper, coated steel sheets, wood or varnish within a temperature range of 0 °C to 1000 °C.

The spectral pyrometers PZ 20 and PZ 30 are used for temperature measurements from 250 °C to 2000 °C or 700 °C to 2500 °C, respectively. Their applications lie in wide fields of the iron and steel producing industry and the metal, glass, ceramics and chemical industry.

The two-colour pyrometers PZ 4x, PZ 5x measure the intensity of infrared radiation at two different wavelengths. The ratio of these two intensities is proportional to the temperature. Thus the two-colour pyrometer supplies a constant measuring signal even with weakened signals, caused, for example, by vapour and dirt in the sighting path, condensation on the optical lenses or by changing surface properties of the target. The applications encompass broad sectors of the iron and steel producing industry and the metal, glass, cement and chemical industries. The temperature range covers 700 °C - 3000 °C (PZ 40) and 500 °C - 1400 °C (PZ 50).

The pyrometers of the PZ 2x, PZ 3x, PZ 4x and PZ 5x series are both available with through-the-lens sighting and as pyrometers with fibre optics.

The pyrometers with fibre optics are preferably used for high ambient temperatures up to 250 °C without cooling or in areas with limited access.

The instruments have rugged aluminium housings which make them ideal for use in hostile industrial environments.

All PZ pyrometers are splash water proof according to IP65 (DIN 40050).

All PZ pyrometers with through-the-lens sighting are equipped with an interchangeable optical system with focussing capability. The through-the-lens sighting with target marker allows an alignment to the target without any problems.

The PZ pyrometers with fibre optics have an integrated laser spot light to permit easy alignment of the sensing head to the target.

The PZ 10 type has a dynamic signal filtering or “smoothing” function. It provides a steady measuring signal and a quick response of the filter for erratic temperature changes of the target.

The adjustable emissivity factor makes it easy to adapt the pyrometer to the different radiation characteristics of the target.

The pyrometers feature a Profibus interface enabling data transmission at speeds of up to 12 Mbaud. This ensures easy integration to existing facilities and control systems.

The devices comply with the essential safety requirements of the Electromagnetic Compatibility Directive 2014/30/EU (EMC Act).

The KELLER HCW Quality Management System meets the DIN EN ISO 9001 Standards for construction, production, repairs and service for non-contact infrared temperature measuring equipment.





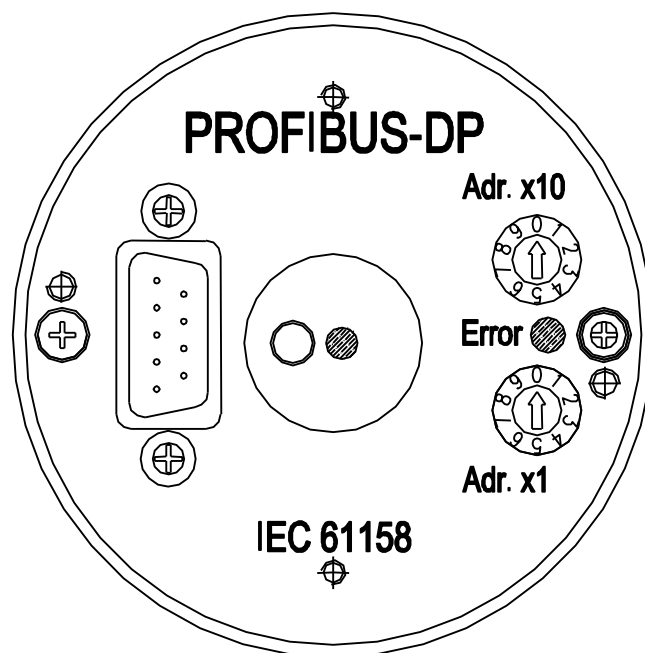

Fig. 1.1 Adjustments at the PZ pyrometers

## 2 Installation

The instrument works with an operating voltage of 24 V DC. The pin assignment and an example for connection are shown in chapter 5. A self test is made when the instrument is switched on. The pyrometer waits to be parameterised / configured by the PROFIBUS DP Master and is then ready for operation. In order to achieve a high degree of measurement accuracy and repeatability it is important to turn on the power supply 15 minutes prior to starting; the pyrometer should have assumed the ambient temperature.

## 3 Handling, Adjustment and Focus

### 3.1 Pyrometer with through-the-lens sighting

When directing the pyrometer with through-the-lens sighting to a target, the lens must be simultaneously focussed on the target and the target marker. The target marker in the sighting path must be covered by the target completely.

**To protect the eye of the viewer against bright light a pivot able polarisation filter for continuously adjustable intensity reduction is provided at the ocular lens (exception: PZ 1x series).**

### 3.2 Pyrometer with fibre optics

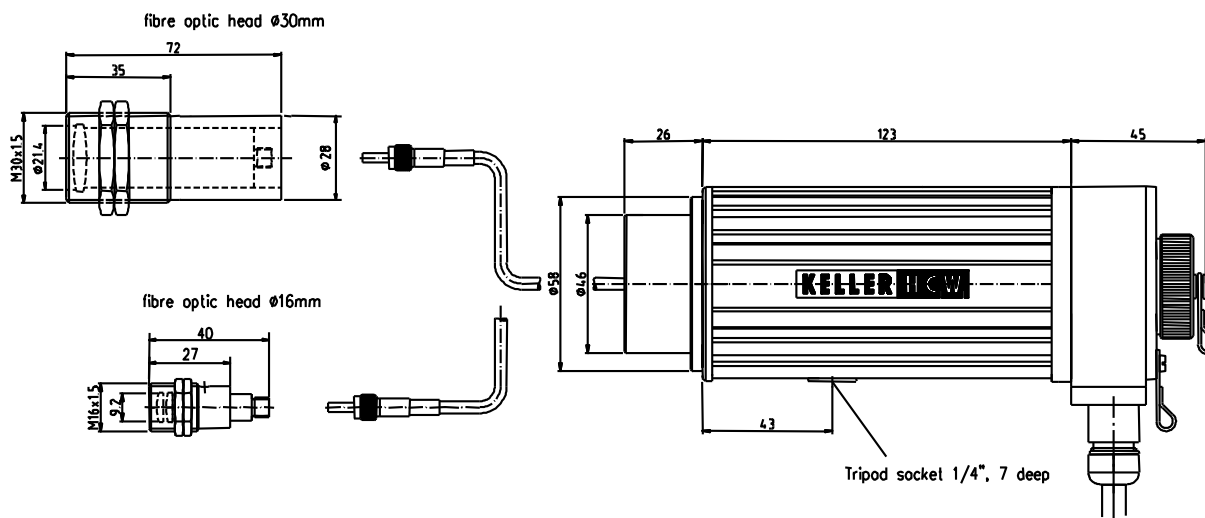

Fig. 3.1 Pyrometer with fibre optics

For focal adjustment loosen the shown socket screw (hexagon socket screw DIN 916) with a wrench (DIN 911) and shift the internal body of the tube towards the lens tube.

Due to the O-ring sealing between the internal body of the tube and the lens tube the focal adjustment must be carried out very slowly so that the air pressure in the space between lens and internal body of the tube can be equalised.

A laser spot light which can be switched on and off with a switch on the rear side of the pyrometer serves as a sighting aid. It will automatically switch off after approximately 2 min. (see Chapter 3.3)

Focus the sensing head until the spot light is shown as a sharp round laser spot in the target area. In bright daylight or in an excessively lit environment it is recommendable to dim the area around the target.

One end of the optical fibre has a name plate showing the serial number of the corresponding basic pyrometer. This is the end which must be screwed onto the pyrometer. For proper connection, the arrow on the name plate of the fibre optic cable and the arrow on the pyrometer should point toward each other. The serial number of the measuring head should also correspond to the pyrometer.

**General Remarks:**

The fibre optic cable must not be exposed to tensile load and must not be twisted. The minimum bending radius is 125 mm.

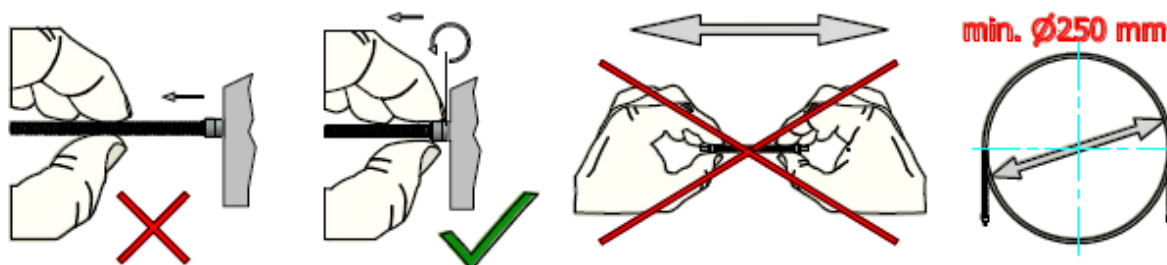

All technical details you find in the technical data sheet of the fibre optic cable.

**3.3 Pyrometer with laser spot light**

The pyrometer models PZxx AF4xx/L feature an integrated laser spot light which can be activated to facilitate instrument alignment to the target spot. To activate the laser, first unscrew and remove the back cover, then press the button. **Please read and follow the safety precautions in Chapter 3.5!** The laser spot light will automatically deactivate after 2 minutes. Alternatively, press the button once more to turn the laser off.

The laser is automatically protected against capacity overload by a protective circuit. When the internal temperature of the pyrometer exceeds 40 °C the laser will blink; the blinking will become more rapid as the temperature increases. The laser will automatically shut off and cannot be reactivated at internal temperatures above 65 °C. The LED located on the pyrometer's back side next to the button will also light up to indicate that the laser is activated. Likewise, the LED will extinguish when the laser deactivates.

**3.4 Focussing**

To determine optimal focussing of very small targets (when the actual measured spot is the same size or only insignificantly larger than the required minimum target spot size according to the distance ratio), it is optimal to use one of the spectral channels as it will indicate the highest intensity and thus the maximum temperature value better than the pyrometer's two-colour measuring function.

### **3.5 General Laser Use and Precautions**

#### **3.5.1 Laser Influence on Temperature Reading**

For pyrometers featuring an integrated laser spot light, the light may, when activated, influence the instrument's temperature reading. This influence will vary, depending on the instrument model and the temperature. To ensure an accurate and reliable temperature reading, the laser spot light will automatically deactivate after approximately 2 minutes. The laser is not to be activated during normal operation; its purpose is only to facilitate pyrometer alignment and focussing.

#### **3.5.2 Laser Radiation Hazard**

Laser radiation can be harmful to eye!

The PZ Pyrometer operates with a class 2 red light laser. Direct prolonged viewing of a laser beam can injure the retina. Therefore, the following safety precautions must be strictly observed, otherwise the laser may not be operated!

- Only use the laser to align and focus the pyrometer. Deactivate the laser immediately afterwards. Alternatively, the laser will automatically switch off after 2 minutes.
- Never look directly into the laser beam path.

Do not leave the instrument unattended when the laser is activated.

Do not point the laser beam at other people.

- During pyrometer installation and alignment, make sure to avoid the possibility of laser light reflections caused by reflective surfaces.

All currently valid laser safety standards must be observed.

#### **3.5.3 Laser Power**

The laser operates at a wavelength of 630 - 680 nm (visible red light). The emitted power of the laser beam at the lens opening is max. 1.0 mW. Under normal operating conditions, the emitted radiation does not present a danger to human skin. This laser prod-

uct is classified according to laser class 2, EN60825-1, IEC60825-1.

### 3.5.4 Laser Warning Label

The black and yellow laser warning label is affixed to the bottom side of the instrument. An arrow indicates the laser emission path (lens opening).



Fig. 1.2 Laser warning label affixed to the pyrometer

### 3.5.5 Laser warning label must be visible!

If the pyrometer is installed within a machine or equipment in such a way that the instrument's warning label is visibly blocked, additional laser warning labels (not included in scope of delivery) must be affixed to the equipment or accessory in immediate vicinity to the laser beam emission path opening.

### 3.6 Smoothing Function

Momentary variations in the temperature of the target are eliminated by a smoothing function which provides a steady measuring signal. The response time of the pyrometer is proportional to the time constant. The greater the selected time constant  $t_{98}$ , the less likely it will be that interfering temperature fluctuations will influence the measurement value. It is therefore necessary to allow more time when directing the pyrometer to the target.

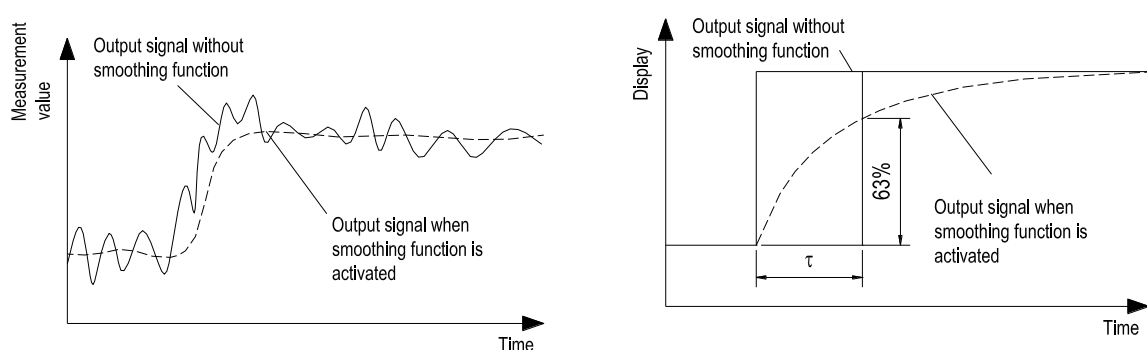

**Fig. 1.3 Effects of the smoothing function**

### 3.7 Peak-Picker

#### Minimal/Maximal value storage with manual deleting

In each measuring period the program compares the current value with the stored minimal/maximal values. When the current value is greater or less than the stored value it will be taken over. The extreme value can be prompted via the PROFIBUS irrespective of the measured value, and can be deleted by resetting the extreme value parameters.

#### Double Maximum Memory with Hold Time $T_h$

It might often be desirable to determine the time limited peak value, for example, when the objects to be measured move past the pyrometer, resulting in a temperature which appears cyclical. In this mode, the extreme value determined by the pyrometer does not drop between targeted objects, but rather is held for a specific selectable hold time. This enables the user to record with certainty a slow drop or rise in the actual temperature.

The hold time is settable from 0.04 sec. to 10 days. The maximum temperature occurring within the hold time will be held and placed in the ex-

temperature value memory. After 50 % of the hold time a second internal peak picker starts. After expiration of the hold time the output signal decreases to the value of the second peak picker. It makes sense to choose a hold time which is approximately 1 ½ times as long as the cycle of the moving targets. This ensures that gaps in the measured temperature are avoided and temperature changes are picked up quickly.

For two-colour pyrometers we recommend using the Double Maximum Memory only together with a smoothing time of at least 120 ms to avoid picking up very short peaks.

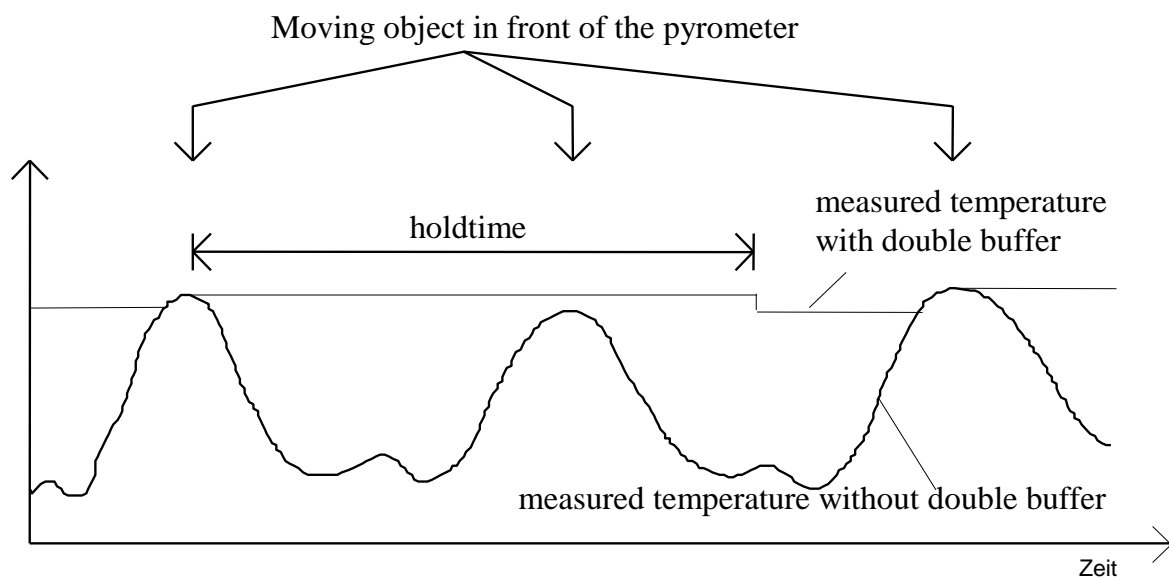

**Fig. 1.4** Function of the Double Maximum Memory (Buffer)

## 4 Theory of Non-Contact Temperature Measurements

Every material emits heat radiation in all states of aggregation above absolute zero. This radiation is mainly caused by atomic or molecular oscillations.

This temperature radiation is only a limited sector within the total electromagnetic radiation spectrum. It extends from the visible range starting at wavelengths of approx. 0.5  $\mu\text{m}$  to the infrared range with wavelengths of more than 40  $\mu\text{m}$ . The KELLER HCW PZ radiation pyrometers use this infrared radiation for non-contact temperature measurements.

### 4.1 Advantages of Non-Contact Temperature Measurements

Non-contact temperature measurement means cost-effective temperature measurement, i. e. only one investment in the measuring instrument without any follow-up costs for consumption materials such as thermocouples for temperatures higher than 1000  $^{\circ}\text{C}$ .

It is also possible to detect moving objects - quick temperature measurements within milliseconds - for example at automatic welding processes.

Small objects with medium and high temperatures are also measured without any problems. Erroneous values will not be obtained when measuring targets with low heat capacity caused by heat drain when applying a contact temperature probe. Moreover, non-contact temperature measurements are ideal for aggressive melts where thermocouples can only be used within limits.

Last but not least it is also possible to measure voltage-carrying objects.

### 4.2 Measurements at Black Bodies (Cavity Radiators)

A black body or a black radiator is used to calibrate radiation pyrometers. This black body is designed in a way that its radiation does not depend on material characteristics, but only on its temperature. A black body emits at any wavelength the maximum energy possible for the specific temperature. Real bodies do not have this ability. In other words, a black body completely absorbs the radiation without reflection or transmission losses. The spectral emissivity coefficient  $\varepsilon(\lambda)$  of a black body is equal to 1.

The emissivity coefficient indicates the relation of radiation of a real body (target) to the radiation of an ideal black body.

$$\varepsilon(\lambda) = \frac{M}{M_s}$$

$\varepsilon(\lambda)$ : Emissivity coefficient of the target at the wavelength  $\lambda$

$M$ : specific radiation of any temperature radiator (target)

$M_s$ : specific radiation of a black body



Most burning, annealing and hardening furnaces emit a radiation of nearly '1' which corresponds to the conditions of a black body if the aperture through which the measurement is made is relatively small.

### 4.3 Measurements of Real Radiators

Real radiation sources are characterized by the relation of the emitted radiation to the radiation of a black body with the same temperature. Measurements outside a furnace - which applies to all other self-contained targets - always show a reading which is too low. Considerable errors can occur at targets with reflecting, polished or bright surfaces, e.g. molten steel and metal without oxide layer and ceramic materials. Exact results can only be obtained when the emissivity coefficient is correctly adjusted on the PZ pyrometer.

The spectral emissivity coefficient of a body does not represent an exact material constant, but is also largely dependent on the surface properties. For different materials the spectral emissivity coefficient  $\varepsilon$  for the spectral ranges  $\lambda = 8...14 \mu\text{m}$  (PZ 10),  $\lambda = 1.23...1,66 \mu\text{m}$  (PZ 20 / PZ 21) and  $\lambda = 0.78... 1.06 \mu\text{m}$  (PZ 30 / PZ 31 / PZ 40 / PZ 41) is shown in the following table:

#### 4.4 Emissivity Coefficient Table PZ 10

List of emissivity coefficients of various materials in %

	<b>PZ 10</b>
<b>Wavelength <math>\lambda</math></b>	<b>8 - 14 <math>\mu\text{m}</math></b>
"Black body"	100
Aluminium oxide	76
Asphalt	90 - 98
Baking oven, dark colour	96
Concrete	55 - 65
Bitumen (roofing paper)	96
Bread in baking oven	88
Ferrous oxide	85 - 89
Enamel	84 - 88
Earth	92 - 96
Paint and varnish, bright	92
“ “ “ , pale	96
Gypsum	80 - 90
Glass	85 - 95
Graphite	98
Rubber, black	94
Skin, human	98
Wood	80 - 90
Radiator	80 - 85
Lime cast	91
Clinker bricks, glazed	75
Cooking plate	95
Synthetic material, no transparent	65 - 95
Copper, oxidized	78
Leather	75 - 80
Marble	94
Brass, oxidized	56 - 64
Paper	70 - 94
Sand	90
Fireclay	75
Steel, stainless	45
Steel, rusty	69
Textiles	75 - 88
Water	92 - 98
Cement	90
Bricks	93 - 96

#### 4.5 Emissivity Coefficient Table PZ 20 – PZ 41

List of emissivity coefficients of different materials in %

	<b>PZ 20 PZ 21</b>	<b>PZ 30 / PZ 31 PZ 40 / PZ 41</b>
<b>Wavelength <math>\lambda</math></b>	<b>1.23 to 1.66 <math>\mu\text{m}</math></b>	<b>0.78 to 1.06 <math>\mu\text{m}</math></b>
"Black Body"	100	100
Aluminium, polished	5	15
Aluminium, blackened	10	25
Asbestos cement	60	70
Bronze, polished	1	3
Bronze, blackened	15	30
Chromium, polished	15	30
Iron, heavily scaled	90	95
Iron, rolling skin	75	90
Iron, liquid	15	30
Gold and silver	1	2
Graphite, blackened	85	90
Copper, oxidized	70	90
Brass, oxidized (tarnished)	50	70
Nickel	8	20
Porcelain, glazed	50	60
Porcelain, rough	75	85
Soot	90	95
Fireclay	40	50
Slag	80	85
Pottery, glazed	85	90
Bricks	85	90
Zinc	40	60

## 5 PROFIBUS DP Interface

### 5.1 PROFIBUS Technology

PROFIBUS is a multivendor compatible field bus standard for a wide scope of application within the fields of measurement engineering and automation. Many different interfaces for e.g. PCs, PLCs etc. are available on the market. Due to national and Europe-wide standardization (EN 50170) PROFIBUS ensures faultless communication between devices of various numerous manufacturers.

The CellaTemp PZ Series pyrometers support the PROFIBUS DP which is designed especially for fast communication at the field level. Data transmission occurs by means of an RS 485 connection and works at speeds of up to 12 Mbaud. Up to 32 PROFIBUS DP stations can be interconnected within a network segment. The use of RS 485 repeaters allow up to 127 stations, including masters, to be connected.

Two other variants of PROFIBUS exist in addition to the PROFIBUS DP:

PROFIBUS PA was designed especially for process automation. It allows slave devices to be connected in potentially explosive environments. With the use of PROFIBUS PA and RS 485-IS, data as well as the supply voltage are transmitted via a four-wire cable. Alternatively, transmission according to RS 485 with a two-wire cable is feasible in non-hazardous areas.

PROFIBUS FMS is the general solution for communication at the cell level.

**Please visit the PROFIBUS user website ([www.profibus.com](http://www.profibus.com)) to find out more about PROFIBUS.**

### 5.2 Cyclical Master-Slave Communication

The PROFIBUS DP differentiates between the connected master und slave devices.

The master controls the bus communication and demands that the assigned slaves transmit or receive data. In a typical master-slave system, input, output, and diagnostics data is exchanged cyclically between the master and those slaves assigned to it. The master (e.g. the PLC) stores the read data in an internal memory for further use by the control program, and writes the output data to the slaves at the end of the next cycle. Thus the image of the data which the master receives from the slave device is only as current as the last completed write/read cycle.

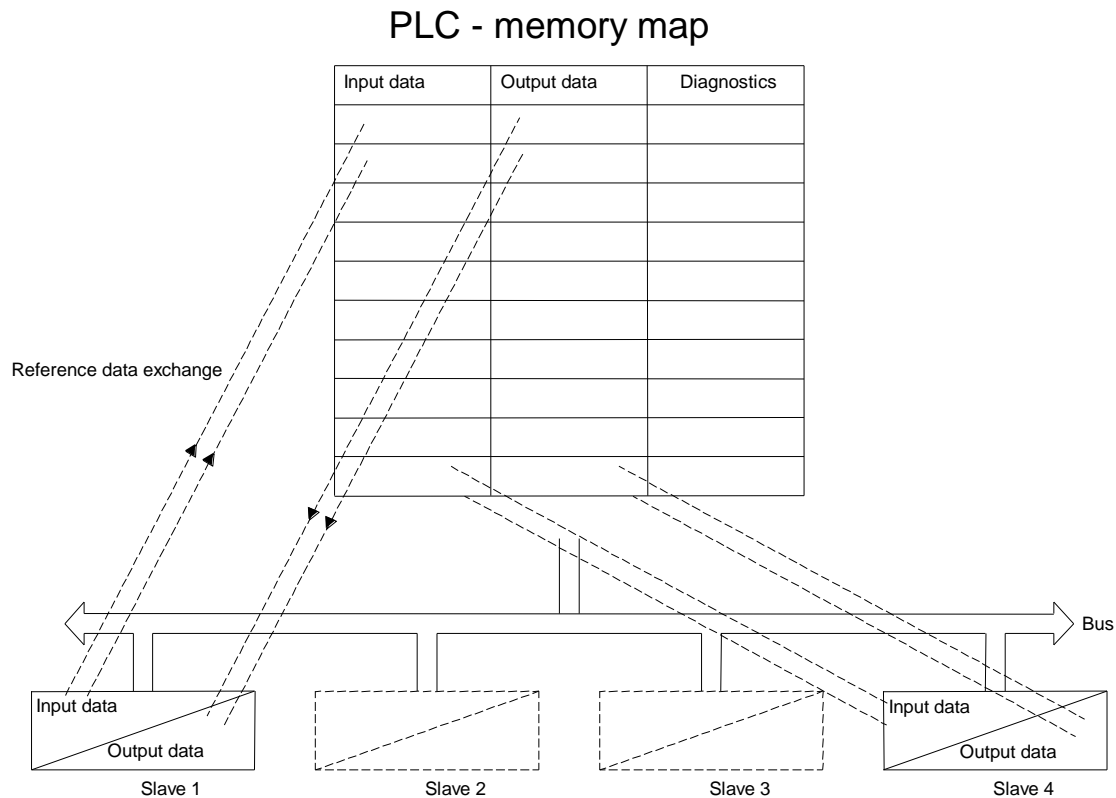

**Fig. 5.1 PROFIBUS master - slave data exchange**

### 5.3 Cable installation

**Connect the CellaTemp PZ pyrometer(s) to additional slaves or to the master using a two-core shielded cable. Two types of bus cables are specified in IEC 61158. The Type B cable is out-of-date and therefore should not be used for new applications.**

Parameter	Cable Type A
Composition of cable	Twisted pair shielded 1x2
Impedance [ $\Omega$ ]	135 - 165 at 3 - 20 MHz
Cable capacitance [pF/m]	<30
Core cross section [mm <sup>2</sup> ]	>0.34, corresponding to AWG22
Wire diameter [mm]	>0.64
Loop resistance [ $\Omega$ /km]	<110

**Table 5.1 PROFIBUS Cable Type**

Maximum cable lengths per segment, depending on the transmission rate:

Transmission rate [kBit/s]	9.6	19.2	45.45	93.75	187.5	500	1500	3000	6000	12000
Max. length [m]	1200	1200	1200	1200	1000	400	200	100	100	100

Spur line sum < 6.6m at a transmission rate up to 1500 kBit/s.  
 Never use spur lines for transmission rates > 1500 kBit/s.  
 Note: The arrangement of the field devices will directly affect the permissible spur line length.

**Table 5.2 PROFIBUS cable lengths**

#### 5.4 Termination of the Profibus-Cable

The bus connector attaches the bus cable to the CellaTemp PZ. A special Profibus connector has been designed specifically for this purpose. The incoming and outgoing data cables are attached to this bus connector. Therefore data communications will not be interrupted if a field device is connected or disconnected to the bus. **The bus terminator must be activated at both ends. To do this, simply push the sliding switches to “ON”.** This will prevent a reflection at the cable end and ensure error-free operation of the RS485 transmission technology.

Typical wiring and bus termination for the RS 485 transmission technology can be depicted as follows:

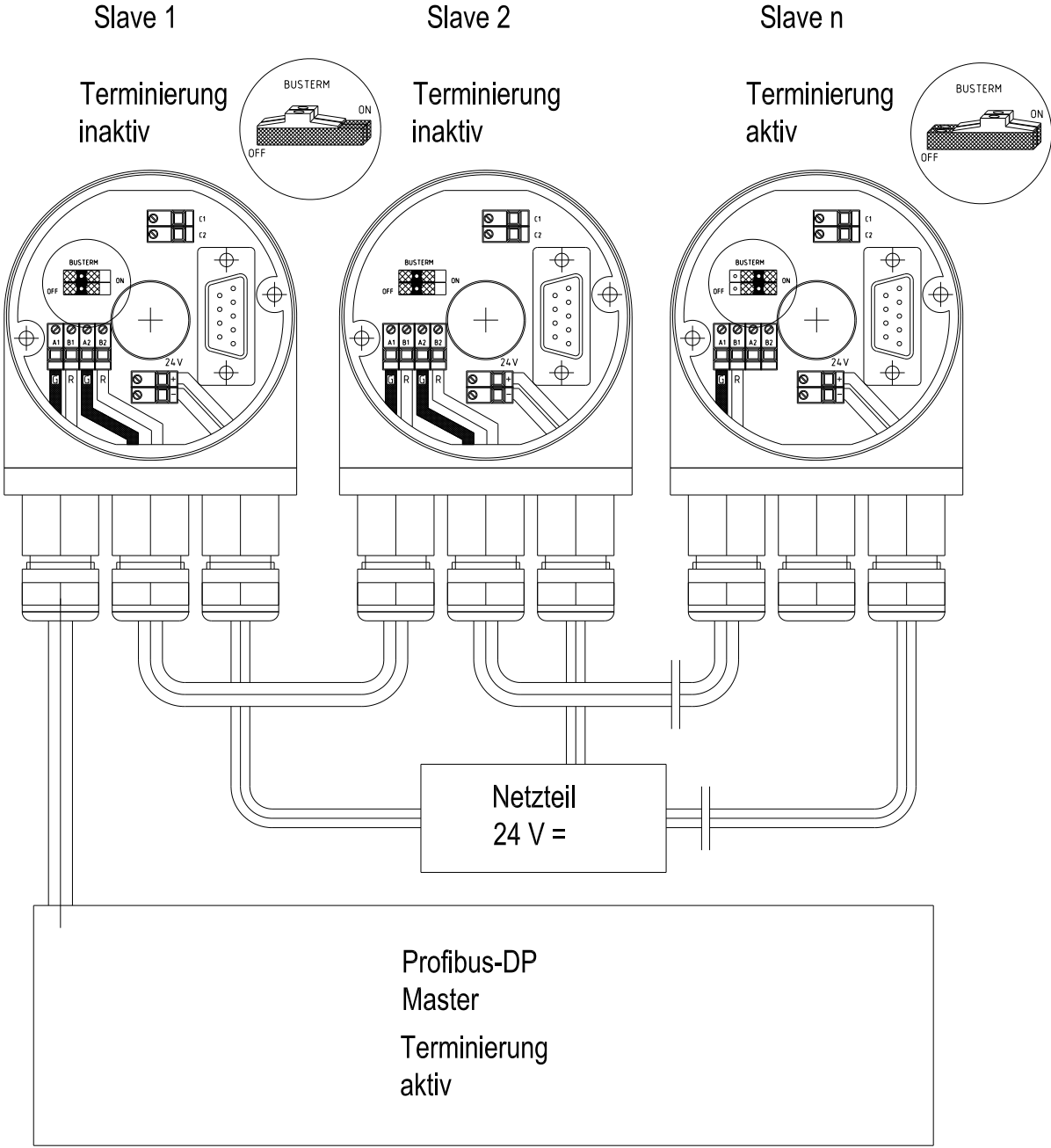

**Fig. 5.2 Typical connection of the CellaTemp PZ**

Power can be supplied to the CellaTemp PZ field devices either centrally by means of one stabilised 24V power supply unit or individually to each of the connected devices. Use a separate two-wire line to connect the power supply to the Profibus bus connector with PG programmer socket at the pyrometer. Select a line with the appropriate core cross section to ensure that 24V direct current (DC) voltage will arrive at the pyrometer (Pin7 = 24P, Pin2 = 24M). The **power LED** on the pyrometer (see Fig. 1.1) confirms the connection of working voltage; it does not however indicate adherence to the permitted voltage range!

A Bus-Error-LED (see Fig. 1.1) indicates the current bus status at the slave device:

**LED on:** cyclic communication inactive, field device seeking bus access  
**LED blinking:** cyclic communication inactive, bus has been accessed  
**LED off:** cyclic communication active

## 5.5 Device address

Each connected device within a profibus system must be approached using an explicit address. Select and set the address using the switches on the CellaTemp PZ pyrometer (see Fig. 1.1) prior to initial operation. It is possible to select an address from 0 to 99. This address may not be used by any other bus network participant and may only be assigned once. The address assigned to the slave device must correspond to the address assignment within the configuration of the master (at the PLC or PC) to ensure unmistakable identification of the measuring instruments.

**Note: The pyrometer will assume the assigned address the very first time the instrument is connected to the 24V supply voltage. The power supply must be disconnected prior to any subsequent change made to the device address.**

## 5.6 GSE File

A GSE file must be available for every DP slave device and is provided by the manufacturer. The file contains data such as Baud rates supported, options/features supported and available I/O signals.

The GSE file of CellaTemp PZ describes, among other things, the data format of the temperature and parameter records (see Chapter 5.8).

GSE files are required for configuration and initial operation set-up. Import the GSE file to the configuration tool prior to configuration.

The configuration tool interprets the data of the GSE file, sets up communication between master and DP slave, and identifies the functions which each DP slave device supports.



**NOTE!**

The GSD file can be downloaded from our homepage Serie CellaTemp PZ. Select the PZ type and download the GSD file at the tab downloads.

**5.7 Parameterization**

The parameter telegram enables the master to identify with the DP slave and defines the mode in which the DP slave should operate. In addition to the parameter settings defined within the norm, the parameter telegram communicates device-specific data. For CellaTemp PZ, these parameter settings apply to measurement value logging and the temperature value format (°C / °F) with which pyrometer operation is initiated.

Byte		Description
1	Standard Telegram according to PROFIBUS Norm	WD/Freeze/Sync/Lock
2		Watchdog Timeout 1
3		Watchdog Timeout 2
4		TSDR
5		Ident. No. HIGH
6		Ident. No. LOW
7		Group ident.
8	DPV1 extension	DPV1 Status 1 (enable DPV1 extension)
9		DPV1 Status 2 (enable various DPV1 functions)
10		DPV1 Status 3
11	Device-specific parameters	Measuring profile number
12		Temperatur unit 0: °Celsius, 1: °Fahrenheit, 2: Kelvin

Table 5.3 Parameter data for CellaTemp PZ

Bytes 11 and 12 in particular refer to CellaTemp PZ and must be set during configuration of the master.

**Byte 11** indicates which profile memory within CellaTemp PZ the pyrometer is using. It contains parameters such as emissivity, averaging and peak memory. The profile data is to be adjusted during operation, for example upon initial use. The once established settings and adjustments will then be stored and can be loaded anytime for specific applications.

Ten application profiles are available, numbered from 0 to 9.

**Byte 12** of the profile specifies the unit of measure with which the pyrometer outputs the temperature reading and with which it expects to receive all temperature-related inputs. Centigrade (Celsius) is the standard setting. Three settings are possible: 0, 1 and 2 (°C, °F, K).

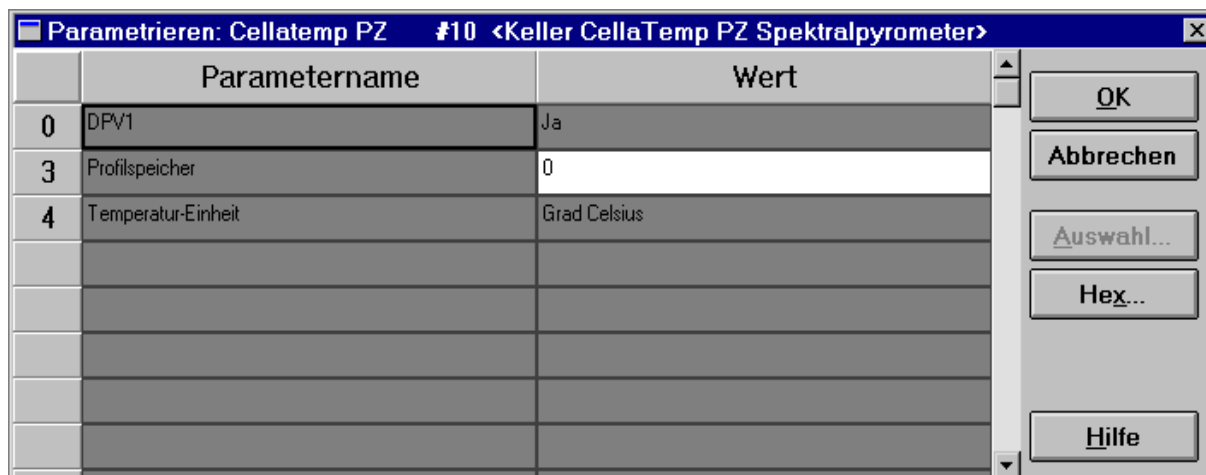

**Fig. 5.3** Parameterization example of the master configuration

Fig. 5.3 gives an example of how the parameters for the CellaTemp PZ spectral pyrometer could be configured. The first parameter defines the use of the PROFIBUS extension according to DPV1. The second parameter selects the profile number 0 and the third parameter defines all temperature values in centigrade (°Celsius).

## 5.8 Configuration

During initialisation of the DP slave device, the master defines the structure of the cyclical data exchange. Possible combinations for these data are described in the GSE File and listed in the configuration tool used.

The CellaTemp PZ is a modular slave. The individual modules exist as software rather than as hardware and deliver and receive module-specific data. The format of this data (number of bytes, I/O) is described in the GSE file. The data of the cyclical data exchange is the sum of the data of all configured modules.

Select only such modules which can actually be used with the pyrometer. The spectral pyrometers (PZ 10/20/21/30) are provided with only the following parameters: internal temperature, and all lambda 1 measurement values. The two-colour pyrometers have, in addition, parameters governing lambda 2 and quotient.

**Example:**

Cyclic transmission of the following data for a spectral pyrometer CellaTemp PZ:

1. Internal temperature (Input)
2. Temperature Lambda1 (Input)
3. Epsilon Lambda1 (Input and Output)

	Kennung	Bestellnummer	Kommentar	E-Adr.	A-Adr.
0	066	Messung: Innentemperatur	4 Byte Eingang		
0E	131			000	
1	066	Messung: Temperatur Lambda 1	5 Byte Eingang		
1E	132			004	
2	194	Parameter: Epsilon Lambda 1	4 Byte Ein-/Ausgang		
2E	131			010	
2A	131				000
3					
4					
5					
6					
7					
8					
9					
10					

**Fig. 5.4 Parameterization example of the master configuration**

Fig. 4.4 depicts the configuration dialog of the Siemens configuration tool COM PROFIBUS. The first module [Slot 0 -> measurement: internal temperature] occupies bytes 0 – 3 of the input data (to be interpreted as a floating-point value). The second module [Slot 1 -> measurement temperature lambda 1] occupies bytes 4 - 9 (float + byte) of the input data. The third module [Slot 2 -> parameter: epsilon lambda 1 occupies bytes 10 – 13 of the input data and bytes 0 – 3 of the output data.

Thus a total of 14 bytes of input data and 4 bytes of output data are transmitted for this slave device.

**Note: Measurement values / parameters from the Lambda 2 or Quotient modules must never be configured in true spectral pyrometers (CellaTemp PZ 10 /20 / 21 / 30).**

**Doing so would inhibit the pyrometer from entering into cyclical data exchange!**

## 5.9 Diagnostics

PROFIBUS provides a convenient way to query the current status of a DP slave. The master requests the DP slave to make a diagnosis. The master executes this process automatically and saves the diagnostic data of each DP slave device in separate memories for each slave. The user software can access this data at any time.

The CellaTemp PZ delivers the diagnosis as a “device-specific diagnosis” whose format is defined in the diagnostics standard and always pertains to the entire device. The CellaTemp PZ pyrometer is a DPV1 slave. Thus the diagnosis of the device contains a status-PDU<sup>1</sup>. The functions of the first four bytes are defined in the standard. Bytes 5 – 8 specifically pertain to the pyrometer and are defined by KELLER HCW.

Byte		Description
1	According to DPV1	Headerbyte
2		Status type (Status Message)
3		Slot Number (0)
4		Specifier (0)
5	Pyrometer data	<b>Status HIGH</b> (Table 4.6)
6		<b>Status LOW</b> (")
7		<b>Error HIGH</b> (")
8		<b>Error LOW</b> (")

**Table 5.4 Configuration of a Status PDU as a device-specific diagnosis**

<b>Status HIGH</b>		
Byte	Bit	Description
5	2 <sup>0</sup> -2 <sup>7</sup>	reserved (0)

<b>Status LOW</b>		
Byte	Bit	Description
6	2 <sup>0</sup> -2 <sup>1</sup>	Enabled access level (see Chap. 5.11) 0: operation 1: service 2: reserved 3: reserved

<sup>1</sup> Status Protocol Data Unit to transmit diagnostic information

	2 <sup>2</sup> -2 <sup>3</sup>	Temperature scale input / output 0: °Celsius / Centigrade 1: °Fahrenheit 2: Kelvin 3: reserved
	2 <sup>4</sup>	User settings are not stored in profile
	2 <sup>5</sup>	Calibration data is not stored permanently
	2 <sup>6</sup> -2 <sup>7</sup>	Reserved (0)

Error HIGH		
Byte	Bit	Description
7	2 <sup>0</sup> -2 <sup>7</sup>	Reserved (0)

Error LOW		
Byte	Bit	Description
8	2 <sup>0</sup>	Internal temperature above 65°C
	2 <sup>1</sup>	EEPROM access error
	2 <sup>2</sup>	Processor error
	2 <sup>3</sup>	Power supply defective / incorrect
	2 <sup>4</sup> -2 <sup>7</sup>	Reserved (0)

Table 5.5 KELLER-defined Data in the Status-PDU

### 5.10 Acyclic Data Exchange

In addition to cyclic data exchange it may often be advantageous to transmit parameters cyclically. That way, individual parameters of the field device can be accessed independent of the cyclic data transmission. The cyclic data transmission can thus be reduced to comprise only the most basic data, thereby requiring less bus capacity and increasing network speed in general.

This is possible as an “optional service” with the PROFIBUS-DPV1 extension technology. A prerequisite for using this service, however, is a master which also supports the DPV1 extension. The CellaTemp PZ supports the acyclic read/write functions of data having variable data stream lengths.

### 5.11 Organisation of CellaTemp PZ Data Sets

The data exchange between the PROFIBUS Master and CellaTemp PZ occurs by means of data sets with their respective predefined functions (see Chap. 6). These data sets can be addressed as stipulated in IEC 61158 (input MODUL and INDEX). Furthermore, the data is also differentiated according to read access or write access. Modules 0 to 3\* are defined in the firmware.

**Module 0:** Data set of **basic instrument**; e.g.internal temperature

**Module 1:** Data set of 1st channel for measured value (**Lambda1**);

e.g. temperature measured

**Module 2\*:** Data set of 2<sup>nd</sup> channel for measured value (**Lambda2**);  
e.g. epsilon

**Module 3\*:** Data set of 3<sup>rd</sup> channel for measured value (**Quotient**);  
e.g. signal strength

\* Modules 2 und 3 exist only in two-colour pyrometers (PZ4x ).

Within a module, data sets are addressed via INDEX. The assignments and descriptions are listed in Chapter 4.11. When reading/writing the data sets, make sure to start the data transmission with the correct number of bytes as shown in **Table 6.1** und **Table 6.2** .

The data sets are divided between two access levels:

0 = "Operation":

Access to all data sets necessary for normal pyrometer operation such as measurement value, epsilon, etc.

1 = "Service":

In addition to Level 0, access to all data sets for profile administration e.g. save / read user settings within non-volatile memory.

In general, access to Level 0 (operation) is always available. To access Level 1 (service), the acyclic command "permit access" must be activated. A code must be entered with this command (Chap. 6) to protect against unauthorised access.

PROFIBUS DPV1 permits both cyclic and acyclic user data exchange between master and slave device.

#### a) **Cyclic transmission occurs constantly**

Cyclic transmission occurs constantly in sequence between master and slave as soon as the parameterization and configuration has been accepted by the slave. The definition of data being cyclically exchanged was already determined for the slave during initial configuration (see Chapter 5.8). The configuration telegram is described in Chapter 6.2. Only those data sets in Table 6 marked with "O" can be configured for cyclic data exchange.

#### b) **Acyclic**

Acyclic transmission between master and slave only occurs at the request of the master. The CellaTemp PZ supports the communication to a Class 1 Master (MSAC\_C1) as well as to a Class 2 Master (MSAC\_C2). Addressing is identical in both cases. All data sets listed in Table 6 are suitable for acyclic data exchange. In addition, it is also permissible to acyclically transmit those data sets which are already included in the cyclic user data exchange. This could make sense if commissioning takes place by means of a Class 2 Master.

The CellaTemp PZ will acknowledge each attempt to transmit an unknown data set (module, index, read/write, length, access level) with an error message.

## 6 Summary of Data Sets

Module	Index	Read/Write	Cyclic	Length (Bytes)	Byte Index	Type: Table 6.3	Meaning	Description
0	0	Rd		116	<b>General Device Information</b>			
					0	⑤	Main version	Version number e.g. 1.0.0
					1	⑤	Secondary version	
					2	⑤	Version	
					3	⑤	EEPROM Version	Version of EEPROM data structure
					4	⑤	User-Profile	Amount of user profile memories
					5	⑤	Cal. Profile	Amount of calibration profile memories
					6	⑤	reserved	
					7	⑤	reserved	
					8..11	⑦	Revision	Instrument revision (see name plate)
					12..15	⑦	Serial number	Serial number (see name plate)
					16..47	⑨	Type text	Designation of model (see name plate)
					48..79	⑨	Calibration text	Calibration comments
					80..111	⑨	Gauger text	Name of gauger
					112	⑤	Day	Date of calibration
113	⑤	Month						
114..115	⑥	Year						
0	0	Wr		1 (3)	<b>Set Access Permission</b>			
					0	⑤	Access level	0: Operation 1: Service
					1..2	⑤	Enable code	Code for level 1: 0xF2, 0x8D Note: Data length is for level 0 = 1 Byte Data length is for level 1 = 3 Byte
0	1	Rd	○	4	<b>Read Internal temperature</b>			
					0..3	⑧	Temperature	Output as floating point in the selected temp. scale
0	16	Rr		1	<b>Read temperature scale</b>			
					0	⑤	Scale	0:°C 1:°F 2:K
0	16	Wr		1	<b>Select temperature scale</b>			
					0	⑤	Scale	0:°C 1:°F 2:K
1, 2, 3	0	Rd		8	<b>Read Measuring Range</b>			
					0..3	⑧	Begin. of range	Output in the selected temp. scale
					4..7	⑧	End of range	
1, 2, 3	1	Rd	○	5	<b>Read Measurement Temperature</b>			
					0..3	⑧	Temperature	Output in the selected temp. scale
					4	⑤	Status	Status of measurement 0: OK 1: too low 2: exceeded 3: invalid
1, 2, 3	2	Rd	○	5	<b>Read Extreme Value Memory</b>			
					0..3	⑧	Temperature	<b>Output in the selected temp. scale</b>
					4	⑤	Status	Status of extreme value 0: OK 1: too low 2: exceeded 3: not valid
3	3	Rd	○	5	<b>Signal strength Quotient compared to Lambda 2</b>			



Module	Index	Read/Write	Cyclic	Length (Bytes)	Byte-Index	Type: Table 6.3	Meaning	Description
3	3	Rd	○	5	<b>Signal strength Quotient compared to Lambda 2</b>			
					0..3	Ⓢ	Signal strength	<b>Relative signal strength in percent</b>
					4	Ⓢ	Status	Status of signal strength 0: OK 1: too low 2: exceeded 3: not valid
1, 2, 3	16	Rd	○	4	<b>Read Epsilon</b>			
					0..3	Ⓢ	Epsilon	Epsilon in percent
1, 2, 3	16	Wr	○	4	<b>Set Epsilon</b>			
					0..3	Ⓢ	Epsilon	Epsilon in percent
1, 2, 3	17	Rd	○	6	<b>Read smoothing</b>			
					0	Ⓢ	Averaging time	0: off 1: fixed time constant, user-selectable 2: automatic adjustment
					1	Ⓢ	Option byte	0: no option
					2..5	Ⓢ	Time	Averaging time T <sub>98</sub> in seconds
1, 2, 3	17	Wr	○	6	<b>Set smoothing</b>			
					0	Ⓢ	Averaging time	0: off 1: fixed time constant, user-selectable 2: automatic adjustment
					1	Ⓢ	Option byte	0: no option
					2..5	Ⓢ	Time	Averaging time T <sub>98</sub> in seconds
1, 2, 3	18	Rd	○	6	<b>Read extreme value</b>			
					0	Ⓢ	Select extreme value	0: off 1: hold minimum value 2: hold maximum value 3: double max with hold time
					1	Ⓢ	Option byte	0: no option
					2..5	Ⓢ	Hold time	Hold time in seconds (only with type 3)
1, 2, 3	18	Wr	○	6	<b>Set extreme value parameters</b>			
					0	Ⓢ	Select extreme value	0: off 1: hold minimum value 2: maximalwert halten 3: double max with hold time
					1	Ⓢ	Option byte	0: no option
					2..5	Ⓢ	Hold time	Hold time in seconds (only with type 3)
3	19	Rd		5	<b>Read signal strength check parameter</b>			
					0	Ⓢ	Select signal strength check	0: signal strength not checked 1: observe minimum signal strength
					1	Ⓢ	Minimum signal strength accepted	Minimum signal strength in percent
3	19	Wr		5	<b>Set signal strength check parameter</b>			
					0	Ⓢ	Select signal strength check	0: signal strength not checked 1: observe minimum signal strength
					1..4	Ⓢ	Minimum signal strength accepted	minimum signal strength in percent
1, 2, 3	128	Rd	○	4	<b>Read Unbounded Temperature Range</b>			
					0..3	Ⓢ	Temperature	Output as floating point in the selected temp. scale

Table 6.1 Data Sets in Access Level 0

Module	Index	Read/Write	Cyclic	Length (Bytes)	Byte Index	Type: Table 6.3	Meaning	Description
0	32	Rd		34	<b>Read Status of Current Profile Storage</b>			
					0	⑤	Current profile	Number of current profile
					1	⑤	Flag	Bits 2 <sup>0</sup> ..2 <sup>1</sup> write lock status : 0: user write lock off 1: user write lock on 2: manufacturer write lock on* (*Profile cannot be overwritten by user) Bits 2 <sup>2</sup> ..2 <sup>7</sup> reserved=0
					2..33	⑨	Text	User text as info for profile
0	32	Wr		34	<b>Select Profile Storage + Action as Necessary</b>			
					0	⑤	Profile to be selected	Number of the profile to be selected
					1	⑤	Action bits	Bit 2 <sup>0</sup> read profile from EEPROM Bit 2 <sup>1</sup> profile in EEPROM set to default Bit 2 <sup>2</sup> write profile in the EEPROM Bits 2 <sup>3</sup> .. 2 <sup>4</sup> Change write lock if necessary 0: unchanged 1: manufacturer write lock on* 2: write lock off* 3: user write lock on (*The user can neither activate nor deactivate the manufacturer write lock) Bits 2 <sup>5</sup> .. 2 <sup>7</sup> reserved=0
					2..33	⑨	Text	If Bit 2 <sup>2</sup> =1 the user text will be written into the EEPROM
Please note: Actions are executed in the order READ → INIT → STORE → WRITE LOCK. A write lock profile cannot be released and overwritten in one step.								
1, 2, 3	48	Rd		4	<b>Read Epsilon from Selected Profile</b>			
					0..3	⑧	Epsilon	Epsilon in Percent
1, 2, 3	48	Wr		4	<b>Write Epsilon from Selected Profile</b>			
					0..3	⑧	Epsilon	Epsilon in Percent
Please note: If the profile is write locked, the slave responds to the write command with an error message.								
1, 2, 3	49	Rd		6	<b>Read Noise Averaging from Selected Profile</b>			
					0	⑤	Averaging time	0: off 1: fixed time constant, selectable 2: automatic adjustment
					1	⑤	Option byte	0: no option
				2..5	⑧	Time	Averaging time T <sub>98</sub> in sec.	
1, 2, 3	49	Wr		6	<b>Write Noise Averaging in Selected Profile</b>			
					0	⑤	Averaging time	0: off 1: fixed time constant, selectable 2: automatic adjustment
					1	⑤	Option byte	0: no option
					2..5	⑧	Time	Averaging time T <sub>98</sub> in sec.
Please note: If the profile is write locked, the slave responds to the write command with an error message								

Modul	Index	Read/Write	Cyclic	Length (Bytes)	Byte-Index	Type: Table 6.3	Meaning	Description
1, 2, 3	50	Rd		6	<b>Read Extreme Value Parameter from Selected Profile</b>			
					0	⑤	Select extreme value	0: off 1: hold min. value 2: hold max. value 3: double max with hold time
					1	⑤	Option byte	0: no option
					2..5	⑧	Hold time	hold time in sec. (only Type 3)
1, 2, 3	50	Wr		6	<b>Write Extreme Value Parameter in Selected Profile</b>			
					0	⑤	Select extreme value	0: off 1: hold min. value 2: hold max. value 3: double max with hold time
					1	⑤	Option byte	0: no option
					2..5	⑧	Hold time	hold time in sec. (only Type 3)
Please note: If the profile is write locked, the slave responds to the write command with an error message								
3	51	Rd		5	<b>Read Signal Strength Check Parameter from Selected Profile</b>			
					0	⑤	Select signal strength check	0: signal strength not checked 1: observe minimum signal strength
					1..4	⑧	Minimum signal strength accepted	Minimum signal strength in percent
3	51	Wr		5	<b>Write Signal Strength Check Parameter from Selected Profile</b>			
					0	⑤	Select signal strength check	0: signal strength not checked 1: observe minimum signal strength
					1..4	⑧	Minimum signal strength accepted	Minimum signal strength in percent

Table 6.2 Data Sets in Access Level 1

### 6.1 Data Sets Used:

#### ⑤ Unsigned8

Octet	8	7	6	5	4	3	2	1
1	2 <sup>7</sup>	2 <sup>6</sup>	2 <sup>5</sup>	2 <sup>4</sup>	2 <sup>3</sup>	2 <sup>2</sup>	2 <sup>1</sup>	2 <sup>0</sup>

#### ⑥ Unsigned16

Octet	8	7	6	5	4	3	2	1
1	2 <sup>15</sup>	2 <sup>14</sup>	2 <sup>13</sup>	2 <sup>12</sup>	2 <sup>11</sup>	2 <sup>10</sup>	2 <sup>9</sup>	2 <sup>8</sup>
2	2 <sup>7</sup>	2 <sup>6</sup>	2 <sup>5</sup>	2 <sup>4</sup>	2 <sup>3</sup>	2 <sup>2</sup>	2 <sup>1</sup>	2 <sup>0</sup>

#### ⑦ Unsigned32

Octet	8	7	6	5	4	3	2	1
1	2 <sup>31</sup>	2 <sup>30</sup>	2 <sup>29</sup>	2 <sup>28</sup>	2 <sup>27</sup>	2 <sup>26</sup>	2 <sup>25</sup>	2 <sup>24</sup>
2	2 <sup>23</sup>	2 <sup>22</sup>	2 <sup>21</sup>	2 <sup>20</sup>	2 <sup>19</sup>	2 <sup>18</sup>	2 <sup>17</sup>	2 <sup>16</sup>
3	2 <sup>15</sup>	2 <sup>14</sup>	2 <sup>13</sup>	2 <sup>12</sup>	2 <sup>11</sup>	2 <sup>10</sup>	2 <sup>9</sup>	2 <sup>8</sup>
4	2 <sup>7</sup>	2 <sup>6</sup>	2 <sup>5</sup>	2 <sup>4</sup>	2 <sup>3</sup>	2 <sup>2</sup>	2 <sup>1</sup>	2 <sup>0</sup>

⑧ Floating Point (according to IEEE-754)

Octet	8	7	6	5	4	3	2	1
1	SN	(E) 2 <sup>7</sup>	(E) 2 <sup>6</sup>	(E) 2 <sup>5</sup>	(E) 2 <sup>4</sup>	(E) 2 <sup>3</sup>	(E) 2 <sup>2</sup>	(E) 2 <sup>1</sup>
2	(E) 2 <sup>0</sup>	(M) 2 <sup>-1</sup>	(M) 2 <sup>-2</sup>	(M) 2 <sup>-3</sup>	(M) 2 <sup>-4</sup>	(M) 2 <sup>-5</sup>	(M) 2 <sup>-6</sup>	(M) 2 <sup>-7</sup>
3	(M) 2 <sup>-8</sup>	(M) 2 <sup>-9</sup>	(M) 2 <sup>-10</sup>	(M) 2 <sup>-11</sup>	(M) 2 <sup>-12</sup>	(M) 2 <sup>-13</sup>	(M) 2 <sup>-14</sup>	(M) 2 <sup>-15</sup>
4	(M) 2 <sup>-16</sup>	(M) 2 <sup>-17</sup>	(M) 2 <sup>-18</sup>	(M) 2 <sup>-19</sup>	(M) 2 <sup>-20</sup>	(M) 2 <sup>-21</sup>	(M) 2 <sup>-22</sup>	(M) 2 <sup>-23</sup>

SN = Leading sign (0 = positive number, 1 = negative number)  
 E = Exponent (8 Bit, double complement with +127 Offset)  
 M = Mantissa (23 Bit, (M) 2<sup>0</sup> is always 1 and will not be transferred)

⑨ String

Octet	8	7	6	5	4	3	2	1	
1									1. Zeichen
2									2. Zeichen
n									...

Table 6.3 Data Types

## 6.2 Layout of the configuration telegram

The CellaTemp PZ will be configured with the **special identifier format**. This special identifier format contains specific manufacturer information for each input/output data record. This information corresponds to the module and the index of the CellaTemp PZ.

Structure of the identifier format incl. manufacturer-specific data:

Byte	Bit	Description
1	2 <sup>0</sup>	Length of manufacturer-specific data
	2 <sup>1</sup>	0 = contains no manufacturer-specific data
	2 <sup>2</sup>	1..14 = length of manufacturer-specific data
	2 <sup>3</sup>	15 = no manufacturer-specific data will follow
	2 <sup>4</sup>	Fixed to 0
	2 <sup>5</sup>	Fixed to 0
	2 <sup>6</sup>	Identifying bits for input/output
	2 <sup>7</sup>	00=no I/O, 01=input only, 10=output only, 11=both
2	2 <sup>0</sup>	Length of the I/O data
	2 <sup>1</sup>	0=1 Byte/Word
	2 <sup>2</sup>	63=64 Bytes/Word
	2 <sup>3</sup>	
	2 <sup>4</sup>	
	2 <sup>5</sup>	
	2 <sup>6</sup>	0=Byte, 1=Word
	2 <sup>7</sup>	Data consistency over 0=Bytes/Word, 1=whole length
3	2 <sup>0</sup> ..2 <sup>7</sup>	Module number of the set (Kap. 6)
4	2 <sup>0</sup> ..2 <sup>7</sup>	Index of the set (Kap. 6)

Table 6.4 Configuration Data

The default configuration stored within the CellaTemp PZ may be read out by the master and can be used to boot the slave.

**Default Configuration (spectral pyrometer)**

42H, 83H, 00H, 01H (1. Data set input internal temperature 4 Byte)

42H, 84H, 01H, 01H (2. Data set input measurement temp. 4 Byte)

**Default Configuration (two-colour pyrometer)**

42H, 83H, 00H, 01H (1. Data set input internal temperature 4 Byte)

42H, 84H, 01H, 01H (2. Data set input measurement temp. Mod.1 4Byte)

42H, 84H, 02H, 01H (3. Data set input measurement temp. Mod.2 4Byte)

42H, 84H, 03H, 01H (4. Data set input measurement temp. Mod.3 4Byte)

Of course as an alternative the user may establish his/her own combination of data sets. Doing this requires the build tool (corresponding to the master) and the GSE file.

## 6.3 The GSE-file

```

;=====
; GSE-File for CellaTemp PZ KELLER HCW GMBH
; Auto_Baud_supp, 12MBaud
;
; Stand : 7.9.2001 HM
; File : KELL05CC.GSE
;=====
#Profibus_DP
; Unit-Definition-List:
GSE_Revision=3
Vendor_Name = "KELLER HCW GmbH"
Model_Name = "Cellatemp PZ"
Revision = "V1.0"
Ident_Number = 0x05CC
Protocol_Ident = 0 ; 0=Profibus DP
Station_Type = 0 ; 0=Slave
FMS_supp = 0
Hardware_Release = "/00"
Software_Release = "V 1.x.x"
9.6_supp = 1
19.2_supp = 1
45.45_supp = 1
93.75_supp = 1
187.5_supp = 1
500_supp = 1
1.5M_supp = 1
3M_supp = 1
6M_supp = 1
12M_supp = 1

MaxTsdr_9.6 = 20
MaxTsdr_19.2 = 20
MaxTsdr_45.45 = 20
MaxTsdr_93.75 = 20
MaxTsdr_187.5 = 20
MaxTsdr_500 = 20
MaxTsdr_1.5M = 20
MaxTsdr_3M = 40
MaxTsdr_6M = 80
MaxTsdr_12M = 160

Redundancy = 0
Repeater_Ctrl_Sig = 1 ; Repeater Control-Sig. RS485
; Ausgang
; 24V-Pins als Eingang

24V_Pins = 1
Implementation_Type = "DPC31"
Physical_Interface = 0 ; RS485
Transmission_Delay_9.6 = 0
Transmission_Delay_19.2 = 0
Transmission_Delay_45.45 = 0
Transmission_Delay_93.75 = 0
Transmission_Delay_187.5 = 0
Transmission_Delay_500 = 0
Transmission_Delay_1.5M = 0
Transmission_Delay_3M = 0
Transmission_Delay_6M = 0
Transmission_Delay_12M = 0
Reaction_Delay_9.6 = 0
Reaction_Delay_19.2 = 0
Reaction_Delay_45.45 = 0
Reaction_Delay_93.75 = 0
Reaction_Delay_187.5 = 0
Reaction_Delay_500 = 0
Reaction_Delay_1.5M = 0
Reaction_Delay_3M = 0
Reaction_Delay_6M = 0
Reaction_Delay_12M = 0
End_Physical_Interface

Freeze_Mode_supp = 1 ; Eingänge einfrieren

```

```

Sync_Mode_supp = 0 ; Ausgänge einfrieren
Auto_Baud_supp = 1 ; Automatische Baudrateerkennung
Set_Slave_Add_supp = 0 ; Änderung der Geräteadresse
Min_Slave_Intervall = 1 ; 100us minimaler Slave Zyklus
Modular_Station = 1 ; Modularer Slave
Max_Module = 32 ; Anzahl Module
Max_Input_Len = 48 ; Maximale Länge EingangSEaten
Max_Output_Len = 32 ; Maximale Länge AusgangSEaten
Max_Data_Len = 80 ; Maximale Summe E/A-Daten

; Texte für die Projektierung
PrmText = 1
Text(0) = "No"
Text(1) = "Yes"
EndPrmText

PrmText = 2
Text(0) = "Celsius"
Text(1) = "Fahrenheit"
Text(2) = "Kelvin"
EndPrmText

ExtUserPrmData = 1 "DPV1"
Bit(7) 1 0-1
Prm_Text_Ref = 1
EndExtUserPrmData
ExtUserPrmData = 2 "Profile Storage"
Unsigned8 0 0-9 ; Profilspeicher
EndExtUserPrmData
ExtUserPrmData = 3 "Temperature Unit"
Unsigned8 0 0-2 ; Einheit
Prm_Text_Ref = 2
EndExtUserPrmData

; Gerätespezifische Parametrierung
User_Prm_Data_Len = 5
User_Prm_Data = 0x00,0x01,0x00,0x00,0x00
Max_User_Prm_Data_Len = 32 ; Maximale Länge Parametrierdaten
Ext_User_Prm_Data_Const(0) = 0x00,0x01,0x00,0x00,0x00
Ext_User_Prm_Data_Ref(0) = 1 ; DPV1-Mode enable/disable
Ext_User_Prm_Data_Ref(3) = 2 ; Profilauswahl des Pyrometers
Ext_User_Prm_Data_Ref(4) = 3 ; Temperatur-Einheit

; Modul Definitionen

; 4 Byte (Float) Eingang
Module = "Measurement: Internal Temp." 0x42,0x83,0x00,0x01
1
EndModule

; 4 Byte (Float) Eingang + 1 Byte (Unsigned8) Status
Module = "Measurement: Lambda 1 Temp." 0x42,0x84,0x01,0x01
2
EndModule

; 4 Byte (Float) Eingang + 1 Byte (Unsigned8) Status
Module = "Measurement: Lambda 2 Temp." 0x42,0x84,0x02,0x01
3
EndModule

; 4 Byte (Float) Eingang + 1 Byte (Unsigned8) Status
Module = "Measurement: Quotient Temp." 0x42,0x84,0x03,0x01
4
EndModule

; 4 Byte (Float) Eingang + 1 Byte (Unsigned8) Status
Module = "Measurement: Lambda 1 Extreme" 0x42,0x84,0x01,0x02
5
EndModule

; 4 Byte (Float) Eingang + 1 Byte (Unsigned8) Status
Module = "Measurement: Lambda 2 Extreme" 0x42,0x84,0x02,0x02
6
EndModule

```

```
; 4 Byte (Float) Eingang + 1 Byte (Unsigned8) Status
Module = "Measurement: Quotient Extreme" 0x42,0x84,0x03,0x02
7
EndModule

; 4 Byte (Float) Eingang + 1 Byte (Unsigned8) Status
Module = "Measurement: Quotient Level" 0x42,0x84,0x03,0x03
8
EndModule

; 4 Byte (Float) Eingang+Ausgang
Module = "Parameter: Lambda 1 Epsilon" 0xC2,0x83,0x83,0x01,0x10
9
EndModule

; 4 Byte (Float) Eingang+Ausgang
Module = "Parameter: Lambda 2 Epsilon" 0xC2,0x83,0x83,0x02,0x10
10
EndModule

; 4 Byte (Float) Eingang+Ausgang
Module = "Parameter: Quotient Epsilon" 0xC2,0x83,0x83,0x03,0x10
11
EndModule

; 1 Byte (Unsigned8) AV-Typ + 1 Byte (Unsigned8) AV-Option + 4 Byte
;(Float) Eingang+Ausgang
Module = "Parameter: Lambda 1 Averaging" 0xC2,0x85,0x85,0x01,0x11
12
EndModule

; 1 Byte (Unsigned8) AV-Typ + 1 Byte (Unsigned8) AV-Option + 4 Byte
;(Float) Eingang+Ausgang
Module = "Parameter: Lambda 2 Averaging" 0xC2,0x85,0x85,0x02,0x11
13
EndModule

; 1 Byte (Unsigned8) AV-Typ + 1 Byte (Unsigned8) AV-Option + 4 Byte
;(Float) Eingang+Ausgang
Module = "Parameter: Quotient Averaging" 0xC2,0x85,0x85,0x03,0x11
14
EndModule

; 1 Byte (Unsigned8) Max-Typ + 1 Byte (Unsigned8) Max-Option + 4 Byte
;(Float) Eingang+Ausgang
Module = "Parameter: Lambda 1 Extreme" 0xC2,0x85,0x85,0x01,0x12
15
EndModule

; 1 Byte (Unsigned8) Max-Typ + 1 Byte (Unsigned8) Max-Option + 4 Byte
;(Float) Eingang+Ausgang
Module = "Parameter: Lambda 2 Extreme" 0xC2,0x85,0x85,0x02,0x12
16
EndModule

; 1 Byte (Unsigned8) Max-Typ + 1 Byte (Unsigned8) Max-Option + 4 Byte
;(Float) Eingang+Ausgang
Module = "Parameter: Quotient Extreme" 0xC2,0x85,0x85,0x03,0x12
17
EndModule

; 1 Byte (Unsigned8) Typ + 4 Byte (Float) Limit Eingang+Ausgang
Module = "Parameter: Quotient Level" 0xC2,0x84,0x84,0x03,0x13
18
EndModule

; 4 Byte (Float) Eingang
; To enable a temperature measurement beyond the specific temperature range
; delete the following three semicolons and use the new entry
; "Measurement: Lambda 1 Free Temp." in the configuration of the profibus device.
;Module = "Measurement: Lambda 1 Free Temp." 0x42,0x83,0x01,0x80
;19
;EndModule
```



```
; 4 Byte (Float) Eingang
; To enable a temperature measurement beyond the specific temperature range
; delete the following three semicolons and use the new entry
; "Measurement: Lambda 2 Free Temp." in the configuration of the profibus device.
;Module = "Measurement: Lambda 2 Free Temp." 0x42,0x83,0x02,0x80
;20
;EndModule
```

```
; 4 Byte (Float) Eingang
; To enable a temperature measurement beyond the specific temperature range
; delete the following three semicolons and use the new entry
; "Measurement: Quotient Free Temp." in the configuration of the profibus device.
;Module = "Measurement: Quotient Free Temp." 0x42,0x83,0x03,0x80
;21
;EndModule
```

```
Fail_Safe = 1
Max_Diag_Data_Len = 32 ; Maximale Länge der Diagnose
Modul_Offset = 0 ; Erster Slot beim Projektieren
Slave_Family = 0 ; General
```

```
; DPV1 definitions
DPV1_Slave = 1 ; DPV1 wird unterstützt
C1_Read_Write_supp = 1 ; DS_READ/WRITE für Class 1
C2_Read_Write_supp = 1 ; DS_READ/WRITE für Class 2
C1_Max_Data_Len = 240 ; Max. Datenlänge für azykl. C1
C2_Max_Data_Len = 240 ; Max. Datenlänge für azykl. C2
C1_Response_Timeout = 200 ; Timeout für C1 in 10ms Stufen
C2_Response_Timeout = 200 ; Timeout für C2 in 10ms Stufen
C1_Read_Write_required = 0 ; C1_Read_Write ist notwendig
C2_Read_Write_required = 0 ; C2_Read_Write ist notwendig
C2_Max_Count_Channels = 2 ; Max. Anzahl von C2 Kanälen
Max_Initiate_PDU_Length = 64 ; Max. Länge der C2 Initiate-Req
;Diagnostic_Alarm_supp = 0 ; Diagnose-Alarm in einem Slot
;Process_Alarm_supp = 0 ; Prozess-Alarm in einem Slot
;Pull_Plug_Alarm_supp = 0 ; Modul stecken/ziehen Alarm
;Status_Alarm_supp = 0 ; Status-Alarm in einem Slot
;Update_Alarm_supp = 0 ; Parameter-Update-Alarm
;Manufacturer_Specific_Alarm_supp = 0 ; Herstellerspezifische Alarme
Extra_Alarm_SAP_supp = 0 ; SAP50 für Alarm-Quittungen
Alarm_Sequence_Mode_Count = 0 ; Simultan anstehende Alarme
Alarm_Type_Mode_supp = 0 ; Nur ein Alarm pro Typ
Diagnostic_Alarm_required = 0 ; Alarm-Behandlung ist notwendig
Process_Alarm_required = 0 ; Alarm-Behandlung ist notwendig
Pull_Plug_Alarm_required = 0 ; Alarm-Behandlung ist notwendig
Status_Alarm_required = 0 ; Alarm-Behandlung ist notwendig
Update_Alarm_required = 0 ; Alarm-Behandlung ist notwendig
Manufacturer_Specific_Alarm_required = 0 ; Alarm-Behandlung ist notwendig
DPV1_Data_Types = 0 ; Datentypen aus DPV1
WD_Base_lms_supp = 1 ; lms Timebase für Watchdog
Check_Cfg_Mode = 1 ; Der Slave akzeptiert unter-
; schiedliche Konfigurationen
```

## 7 Integration into the Simatic S7

### 7.1 Integrating the GSE File into the Simatic S7

Prior to inserting CellaTemp PZ to the S7 master system via „Hardware Configuration“, the instrument must be entered into the "Hardware Catalogue".

This is how to do it:

- Install the supplied GSE file to the system via the menu command **Extras > install new GSE file**. A dialog field will appear. Select the disk drive / directory in which the GSE file is to be found.
- The "S7 Hardware Catalogue" must be subsequently updated via **Extras > Update Catalogue**.
- The installed CellaTemp PZ will then appear in the screen "Hardware Catalogue" under "Profibus DP- additional field devices - general".

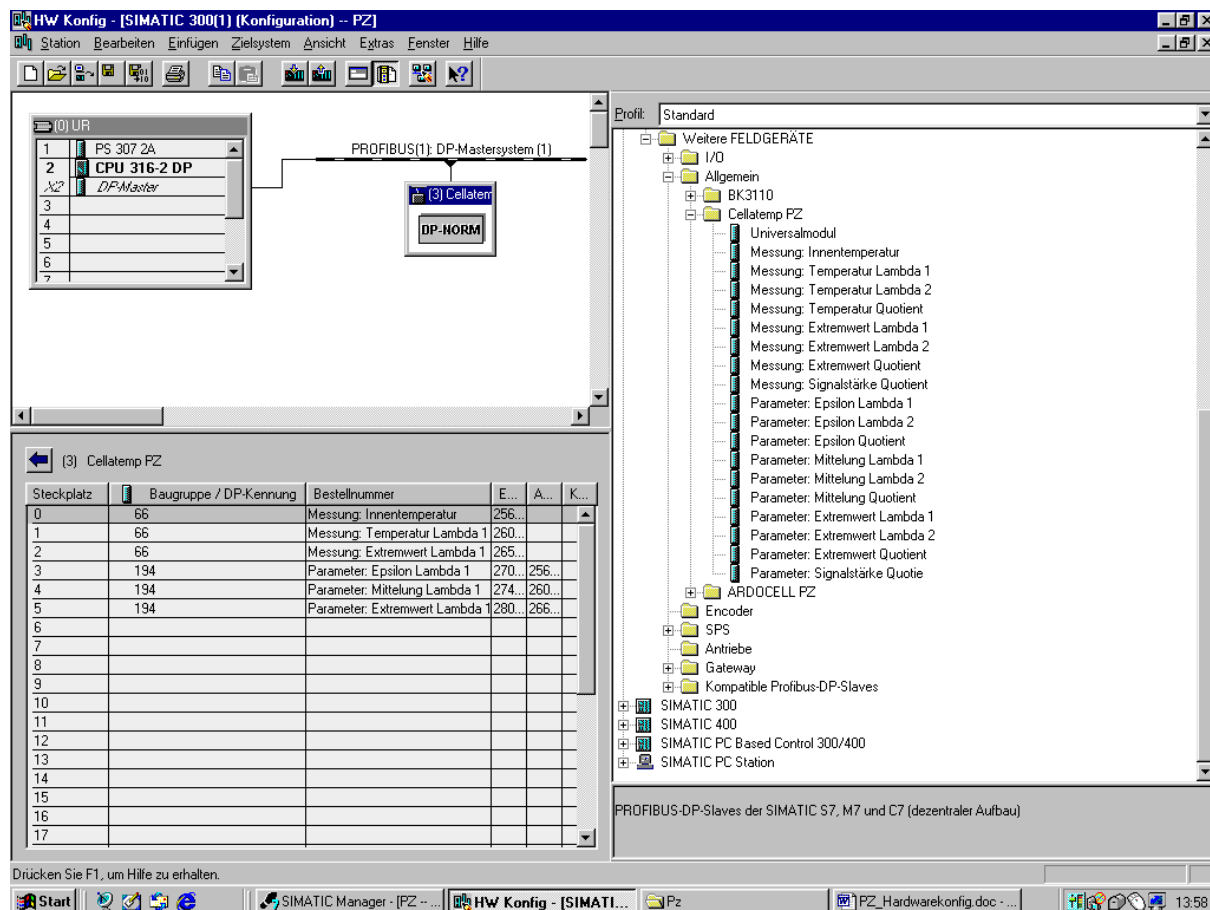

## 7.2 Integrating CellaTemp PZ into a S7 Master System

In our example we selected a CPU 316-2 DP as a master system. When the DP master is placed, the S7 automatically draws a line which represents the master system. By “dragging and dropping” place the CellaTemp PZ at the end of the line.

Because a DP master system is always connected to a PROFIBUS sub-network, STEP 7 automatically displays dialog fields for defining sub-network features and the PROFIBUS address when placing DP components. Indicate the PROFIBUS address which you have selected and set on the backside of the pyrometer. Subnetwork features such as transmission rate are shown in Chapter 5.8.

**Note:** The pyrometer will assume the assigned address the very first time the instrument is connected to the 24 V supply voltage. The power supply must be disconnected prior to any subsequent change made to the device address.

Confirm settings with „OK“. A symbol for the CellaTemp PZ will be attached to the master system.

### 7.3 Configuration of Modular CellaTemp PZ

The CellaTemp PZ is a modular DP slave device.

In the lower part of the station screen a table shows details of the modular DP slave such as DP identification and slot.

With modular DP slaves, the possible modules are arranged in the screen “Hardware Catalog” below the corresponding DP slave “Family”.

The following modules can be integrated into the CellaTemp PZ:

Measurement:	Internal Temperature
Measurement:	Temperature Lambda 1
Measurement:	Temperature Lambda 2
Measurement:	Temperature Quotient
Measurement:	Extreme Value Lambda 1
Measurement:	Extreme Value Lambda 2
Measurement:	Extreme Value Quotient
Measurement:	Signal Strength Quotient
Parameter:	Epsilon Lambda 1
Parameter:	Epsilon Lambda 2
Parameter:	Epsilon Quotient
Parameter:	Averaging Lambda 1
Parameter:	Averaging Lambda 2
Parameter:	Averaging Quotient
Parameter:	Extreme Value Lambda 1
Parameter:	Extreme Lambda 2
Parameter:	Extreme Value Quotient
Parameter:	Signal Strength Quotient

**Please note:**

Maximum number of bytes which can be output 32 Byte

For a spectral pyrometer (PZ 10 – PZ 31), we recommend that you integrate the following modules:

- Measurement: internal temperature
- Measurement: temperature Lambda 1
- Parameter: Epsilon Lambda 1
- Parameter: Average Lambda 1

For a two-colour pyrometer (PZ 40 – PZ 60), we recommend that you integrate the following modules:

- Measurement: Internal temperature
- Measurement: Temperature Quotient
- Parameter: Epsilon Quotient
- Parameter: Average Quotient

To integrate a module into the DP slave, drag the module and drop it on to the configuration table (lower part of the station screen) and then double-click the corresponding line. The master system will suggest I/O addresses; however, these addresses can be customised by the user within system limits.

**Note: Select only such modules which correspond to the functional range of the specific CellaTemp PZ model (->5.8) so that they can actually be utilised.**

Now load your "Hardware Configuration" into the S7 master system.

#### 7.4 Parameters in Siematic STEP 7

The interface for measurement values and parameters within the S7 program are the configured I/O addresses.

The data of an integrated module are "**consistent data**", i.e. data which belong together in regard to content and may not be separated from each other.

You will require the SFC 14 "DPRD\_DAT" or SFC 15 "DPWR\_DAT" in order to consistently access either three or more than four bytes of a DP slave.

These Step7 standard functions are called in the following function blocks:

FC\_measuring values (FC101)  
FC\_parameter\_reading (FC102)  
FC\_parameter\_writing (FC103)  
FC\_PARA\_reading\_5Byte (FC104)  
FC\_PARA\_writing\_5Byte (FC105)

The E/A address of the integrated module is accessed as input to these function blocks.

Please Note:

The FC104 and FC105 functions have the purpose of reading/writing 5 byte modules. These modules contain parameters. For example signal strength. You must use FC104 and FC105 to read/write the parameters contained in these modules.

KELLER has configured the communication for **one** CellaTemp PZ in the FB 10 of the sample program. The measurement values and parameters are deposited in the DB 10. The organisation block (OB) in the program represents the interface between the operating system of the CPU and the user program. When connecting or disconnecting the CellaTemp PZ from Profibus, those system OB's are processed which diagnose the incident in question. If you have not programmed the OB's, the CPU will go into the STOP operational mode.

Further information is available via the S7 online assistance or in the Siemens user manuals.

## **8 Maintenance**

### **8.1 Cleaning the pyrometer lens**

A false reading will be given when the lens is dirty. Therefore check the lens periodically and clean it, if necessary.

Dust can be removed by simply blowing it away or by using a soft brush. If the lens is quite dirty, use a very mild liquid detergent and rinse carefully with clear water. Apply as little pressure as possible to the lens to avoid scratches.

Make sure to turn off the pyrometer prior to connecting or disconnecting the coupler connector (e.g. when cleaning). Failure to do so may result in damage to the instrument!

#### **Please note:**

**The pyrometer must be protected against high ambient temperatures, high air humidity, high voltage and strong electro-magnetic fields. Never hold the lens directly into the sun.**

## 9 Technical Data PZ 10

**Measuring ranges  
(adjustable in partial ranges):**

0 to 1000 °C

**Sensor:**

thin-film thermopile

**Spectral sensitivity:**

8 to 14  $\mu\text{m}$

**Focussing range:**

0.15 to 0.3 m (close-up lens)

0.3 m to  $\infty$  (standard lens)

**Distance to target size  
ratio:**

38 : 1 (close-up lens)

40 : 1 (standard lens)

**Response time  $t_{90}$ :**

$\leq 100$  ms

**Resolution:**

$\leq 0.5$  K

(if smoothing is  $\geq 30$  ms)

**Linearization:**

digital via microcontroller

**Measuring uncertainty:**

1 % of range and but at least

2 K

(at  $\varepsilon = 1.0$  and  $T_a 23$  °C)

**Repeatability:**

1 K

**Sighting device:**

through-the-lens sighting with  
target marking

**Ambient operating  
temperature range:**

0 to 60 °C

**Storage temperature  
range:**

-20 to 70 °C

**Permissible humidity:**

95% r.H. max.

(non-condensing)

**Temperature coefficient  
with reference to 23 °C:**

$\leq 0.1\text{K} / \text{K}$  (to  $T_a \leq 200$  °C)

$\leq 0.05\% / \text{K}$  (to  $T_a \geq 200$  °C)

of measured value

**Interface:**

PROFIBUS DP with extension for DPV1 Certified by the PNO (Profibus user's organisation)

Certificate No.: Z00704

max. transmission rate:

12 MBaud

**Device address:**

0 to 99

adjustable about switches

**Power supply requirements:**

22 - 27 V DC /  $\leq 80$  mA

Ripple:  $\leq 200$  mV

**Dimensions:**

$\phi 65 \times 180$  mm

**Housing material:**

aluminium

**Connection:**

terminal clamp

(PROFIBUS Norm)

**Weight:**

$\leq 0.5$  kgs

**Protection:**

IP 65 according to DIN 40050

**Adjustable parameters:**

**retrievable measured values:**

temperature spectral

channel 1

device temperature

**Adjustable parameters:**

Emissivity Coefficient

Smoothing function

Peak-picker

**Optional accessories:**

calibration certificate:

according to ISO 9001

calibration certificate:

according to DKD

large variety of mounting devices, digital displays, software, etc.



### 9.1 Target Diagram PZ 10

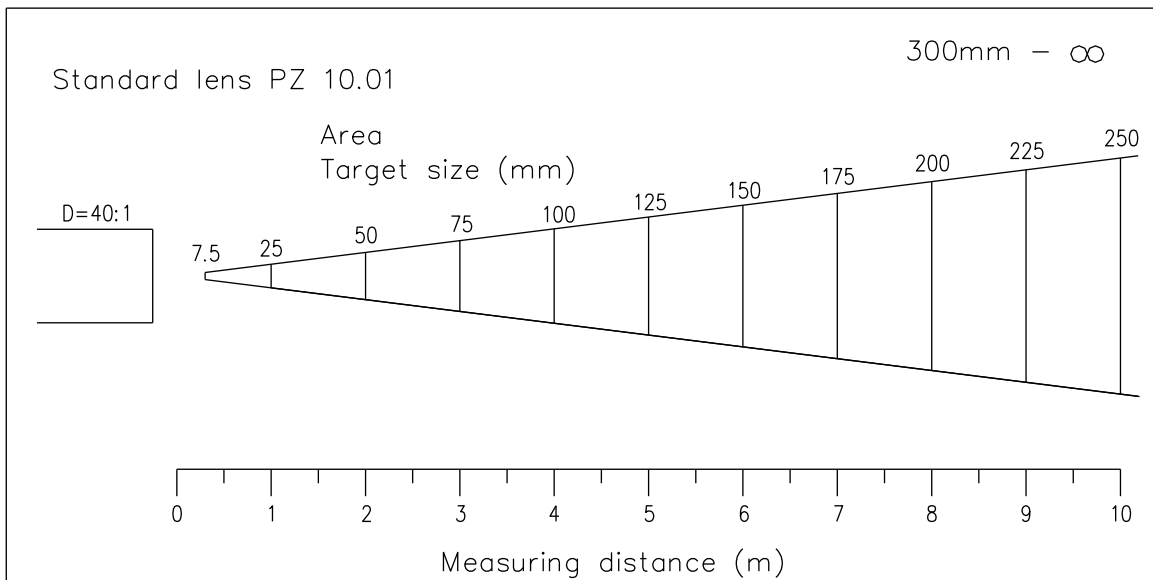
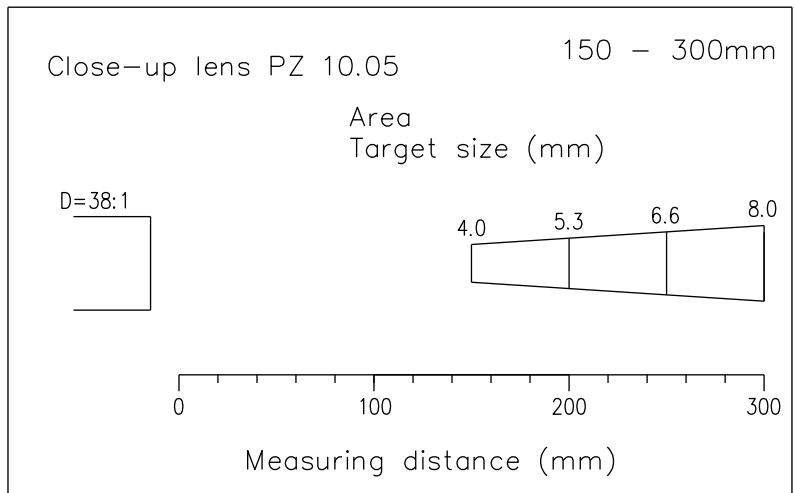

## 10 Technical Data PZ 15

### Measuring ranges (adjustable in partial ranges):

1000 to 1000 °C (AF 401)  
300 to 1300 °C (AF 402)

### Sensor:

thin-film thermopile

### Spectral sensitivity:

4.46 to 4.82  $\mu\text{m}$

### Focussing range:

0.6 to  $\infty$  (AF 401)  
0.3 m to  $\infty$  (AF 402)

### Distance to target size ratio:

55 : 1 (95%) (AF 401)  
40 : 1 (90%) (AF 402)

### Response time $t_{90}$ :

$\leq 100$  ms

### Resolution:

$\leq 1.5$  K  
(at  $\varepsilon = 1.0$  and  $T_a 23$  °C and  
smoothing  $t_{98} = 5$  sec. )

### Linearization:

digital via microcontroller

### Measuring uncertainty:

1 % of range and but at least  
2 K  
(at  $\varepsilon = 1.0$  and  $T_a 23$  °C and  
smoothing  $t_{98} = 5$  sec. )

### Repeatability:

3 K

### Sighting device:

through-the-lens sighting with  
target marking

### Ambient operating temperature range:

0 to 60 °C

### Storage temperature range:

-20 to 70 °C

### Permissible humidity:

95% r.H. max.  
(non-condensing)

### Temperature coefficient with reference to 23 ° C:

$\leq 0.05\text{K} / \text{K}$   
of measured value

### Interface:

PROFIBUS DP with extension  
for DPV1 Certified by  
the PNO (Profibus user's  
organisation)  
Certificate No.: Z00704

max. transmission rate:  
12 MBaud

### Device address:

0 to 99  
adjustable about switches

### Power supply requirements:

22 - 27 V DC /  $\leq 80$  mA  
Ripple:  $\leq 200$  mV

### Dimensions:

$\phi 65 \times 180$  mm

### Housing material:

aluminium

### Connection:

terminal clamp  
(PROFIBUS Norm)

### Weight:

$\leq 0.5$  kgs

### Protection:

IP 65 according to DIN 40050

### Adjustable parameters:

#### retrievable measured values:

temperature spectral  
channel 1  
device temperature

### Adjustable parameters:

Emissivity Coefficient  
Smoothing function  
Peak-picker

### Optional accessories:

calibration certificate:  
according to ISO 9001

calibration certificate:  
according to DKD

large variety of mounting  
devices, digital displays,  
software, etc.

### 10.1 Target Diagram PZ 15

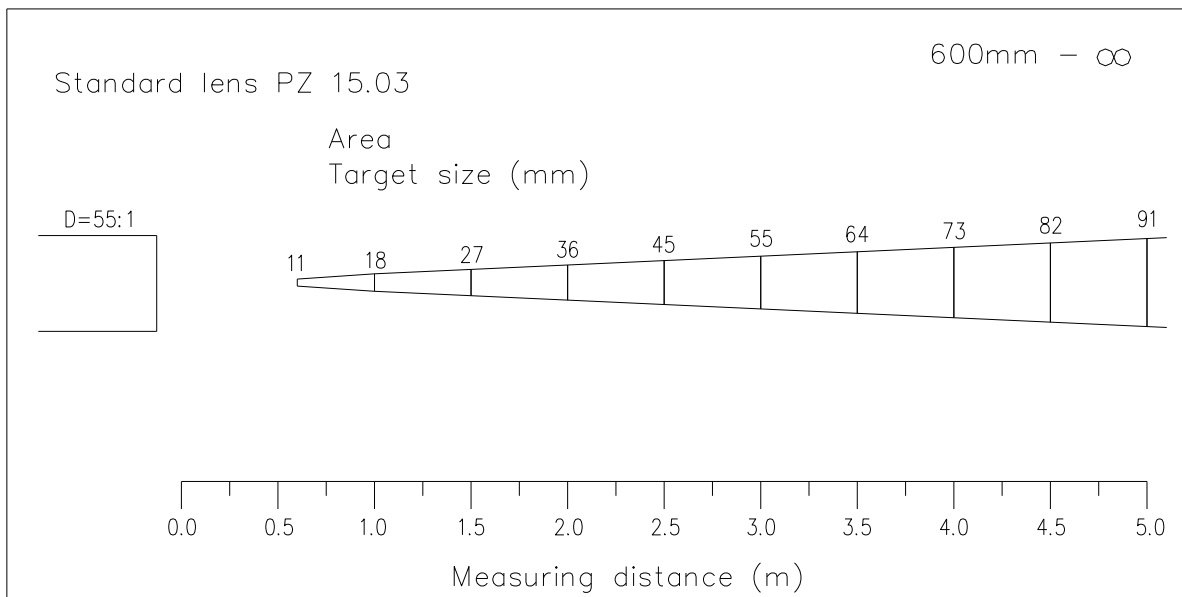

**PZ15 AF 401**

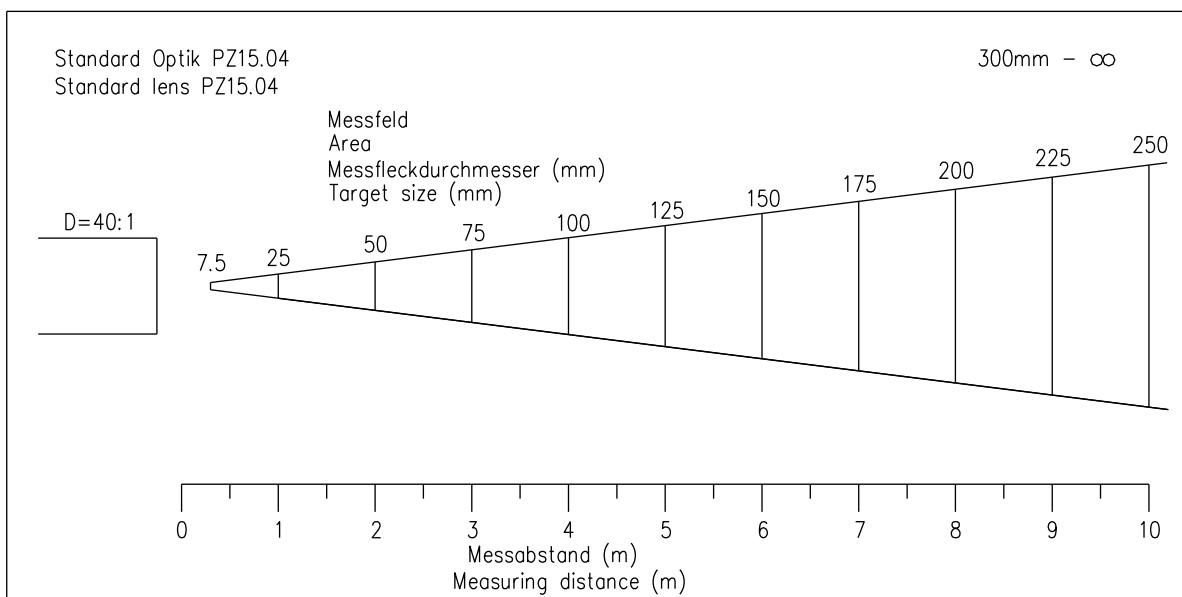

**PZ15 AF 402**

## 11 Technical Data PZ 20

**Measuring ranges (adjustable in partial ranges):**

250 to 2000 °C  
350 to 2500 °C

**Sensors:**  
photo diode

**Spectral sensitivity:**  
1.1 to 1.7 µm

**Focussing range:**  
0.2 to 0.4 m (close-up lens)  
0.4 m to ∞ (standard lens)  
0.2 m to ∞ (wide-angle lens)  
1.2 m to ∞ (telephoto lens)

**Distance to target-size ratio:**

Close-up	140:1
Stand. lens	150:1
Wide angle	32:1
Tel. lens	200:1

**Response time  $t_{98}$ :**  
≤ 40 ms for  $T \geq 750$  °C

**Linearization:**  
digital via microcontroller

**Measuring Uncertainty:**  
0.75 % of measured value or 2K  
(at  $\varepsilon = 1.0$  and  $T_a 23$  °C)

**Repeatability:**  
1 K

**Resolution:**  
≤ 1 K  
(if smoothing is  $\geq 80$  ms)

**Sighting device:**  
through-the-lens sighting with target marking

**Ambient operating temperature range:**  
0 to 60 °C

**Storage temperature range:**  
-20 to 70 °C

**Permissible humidity:**  
95% r.H. max.  
(non-condensing)

**Temperature coefficient with reference to 23 °C:**  
0.25 K / K (for  $T < 500$  °C)  
0.05 % / K (for  $T > 500$  °C)  
of measured value

**Interface:**  
PROFIBUS DP with extension for DPV1 Certified by the PNO (Profibus user's organisation) Certificate No.: Z00704

max. transmission rate:  
12 MBaud

**Device address:**  
0 to 99  
adjustable about switches

**Power supply requirements:**  
22 - 27 V DC / ≤ 80 mA  
Ripple: ≤ 200 mV

**Dimensions:**  
φ 65 x 200 mm

**Housing material:**  
aluminium

**Connection:**  
terminal clamp  
(PROFIBUS Norm)

**Weight:**  
≤ 0.8 kg

**Protection:**  
IP 65 according to DIN 40050

**Adjustable parameters:**

**retrievable measured values:**

temperature spectral  
cannel 1  
device temperature

**Adjustable parameters:**

Emissivity Coefficient  
Smoothing function  
Peak-picker

**Optional accessories:**

calibration certificate  
according to ISO 9001

calibration certificate according to DKD

large variety of mounting  
devices digital displays,  
software, etc.

### 11.1 Target Diagram PZ 20

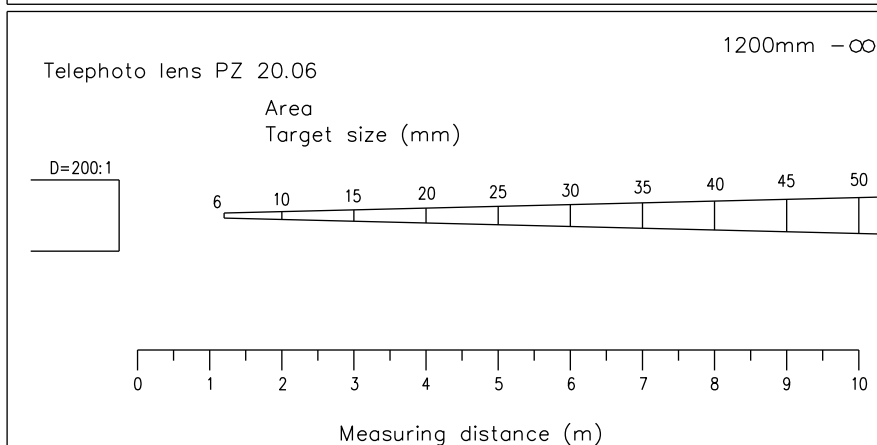
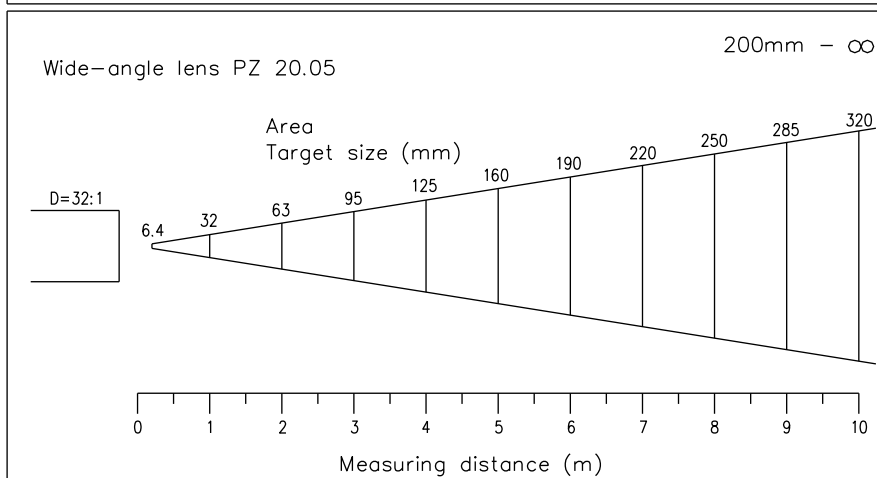
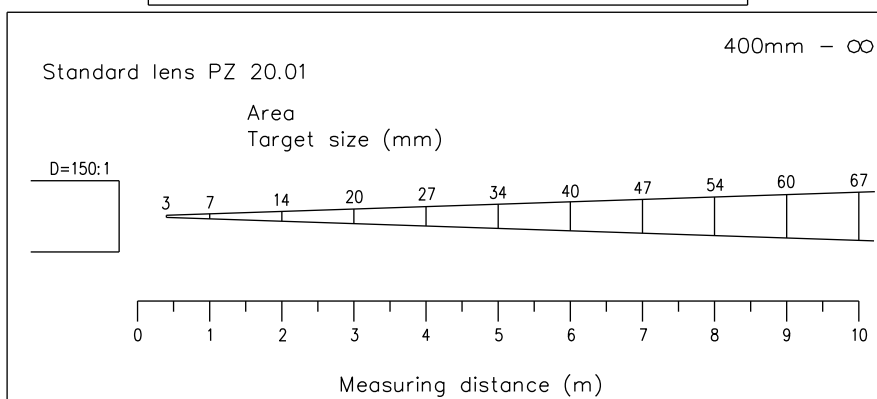
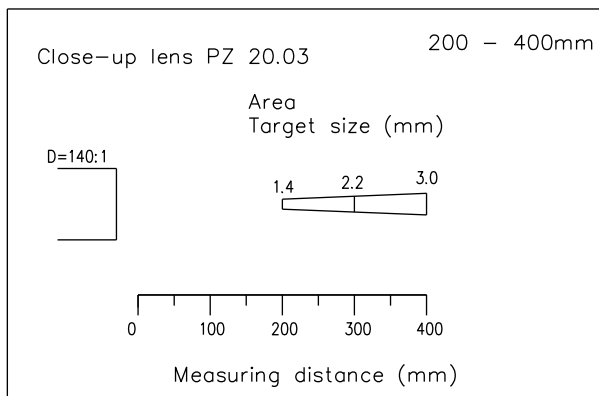

## 12 Technical Data PZ 30

**Measuring ranges (adjustable in partial ranges):**

500 to 2500 °C  
800 to 3000 °C

**Sensors:**  
photo diode

**Spectral sensitivity:**  
0.8 to 1.1 μm

**Focussing range:**  
0.2 to 0.4 m (close-up lens)  
0.4 m to ∞ (standard lens)  
0.2 m to ∞ (wide-angle lens)  
1.2 m to ∞ (telephoto lens)

**Distance to target-size ratio:**

Close-up	140:1
Stand. lens	175:1
Wide angle	35:1
Tel. lens	240:1

**Response time t<sub>98</sub>:**  
≤ 40 ms for T ≥ 750 °C

**Linearization:**  
digital via microcontroller

**Measuring Uncertainty:**  
0.75 % of measured value or 2K  
(at ε = 1.0 and T<sub>a</sub> 23 °C)

**Resolution:**  
≤ 1 K  
(if smoothing is ≥ 80 ms)

**Repeatability:**  
1 K

**Sighting device:**  
through-the-lens sighting with target marking

**Ambient operating temperature range:**  
0 to 60 °C

**Storage temperature range:**  
-20 to 70 °C

**Permissible humidity:**  
95% r.H. max.  
(non-condensing)

**Temperature coefficient with reference to 23 °C:**  
0.25 K / K (for T < 500 °C)  
0.05 % / K (for T > 500 °C)  
of measured value

**Interface:**  
PROFIBUS DP with extension for DPV1 Certified by the PNO (Profibus user's organisation)  
Certificate No.: Z00704

max. transmission rate:  
12 MBaud

**Device address:**  
0 to 99  
adjustable about switches

**Power supply requirements:**  
22 - 27 V DC / ≤ 80 mA  
Ripple: ≤ 200 mV

**Dimensions:**  
φ 65 x 200 mm

**Housing material:**  
aluminium

**Connection:**  
terminal clamp  
(PROFIBUS Norm)

**Weight:**  
≤ 0.8 kg

**Protection:**  
IP 65 according to DIN 40050

**Adjustable parameters:**

**retrievable measured values:**

temperature spectral  
cannel 1  
device temperature

**Adjustable parameters:**

Emissivity Coefficient  
Smoothing function  
Peak-picker

**Optional accessories:**

calibration certificate  
according to ISO 9001

calibration certificate according to DKD

large variety of mounting devices digital displays, software, etc.

## 12.1 Target Diagram PZ 30

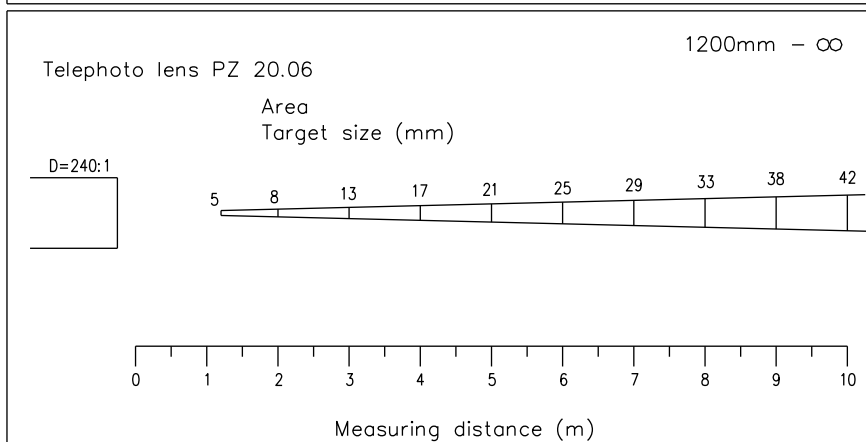
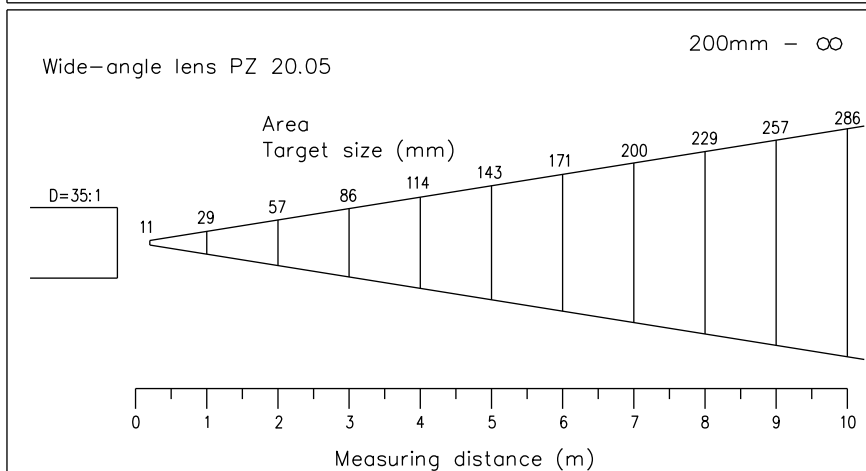
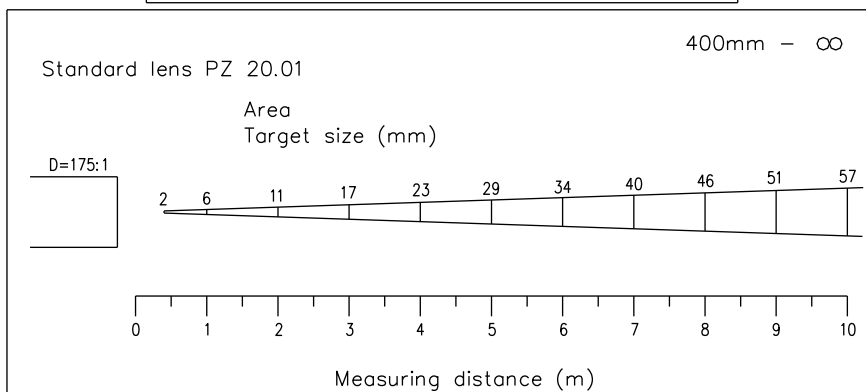
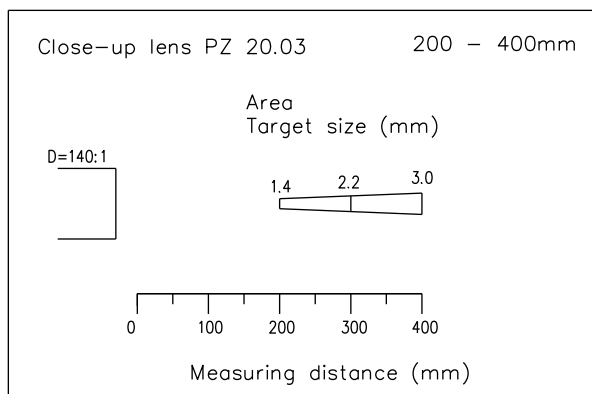

## 13 Technical Data PZ 35

**Measuring ranges (adjustable in partial ranges):**

600 to 2500 °C

**Sensors:**

photo diode

**Spectral sensitivity:**

0.85 to 0.91 μm

**Focussing range:**

0.2 to 0.4 m (close-up lens)

0.4 m to ∞ (standard lens)

0.2 m to ∞ (wide-angle lens)

1.2 m to ∞ (telephoto lens)

**Distance to target-size ratio:**

Close-up 140:1

Stand. lens 175:1

Wide angle 35:1

Tel. lens 240:1

**Response time t<sub>98</sub>:**

≤ 40 ms for T ≥ 700 °C

**Linearization:**

digital via microcontroller

**Measuring Uncertainty:**

0.5 % of measured value  
(at ε = 1.0 and T<sub>a</sub> 23 °C)

**Repeatability:**

1 K

**Resolution:**

≤ 0.2 K

(at ε = 1.0 and T<sub>a</sub> 23 °C)

**Sighting device:**

through-the-lens sighting with target marking

**Ambient operating temperature range:**

0 to 60 °C

**Storage temperature range:**

-20 to 70 °C

**Permissible humidity:**

95% r.H. max.

(non-condensing)

**Temperature coefficient with reference to 23 °C:**

0.04 % / K of measured value

**Interface:**

PROFIBUS DP with extension for DPV1 Certified by the PNO (Profibus user's organisation)

Certificate No.: Z00704

max. transmission rate:

12 MBaud

**Device address:**

0 to 99

adjustable about switches

**Power supply requirements:**

22 - 27 V DC / ≤ 80 mA

Ripple: ≤ 200 mV

**Dimensions:**

φ 65 x 200 mm

**Housing material:**

aluminium

**Connection:**

terminal clamp (PROFIBUS Norm)

**Weight:**

≤ 0.8 kg

**Protection:**

IP 65 according to DIN 40050

**Adjustable parameters:**

**retrievable measured values:**

temperature spectral  
cannel 1  
device temperature

**Adjustable parameters:**

Emissivity Coefficient  
Smoothing function  
Peak-picker

**Optional accessories:**

calibration certificate according to ISO 9001

calibration certificate according to DKD

large variety of mounting devices digital displays, software, etc.



### 13.1 Target Diagram PZ 35

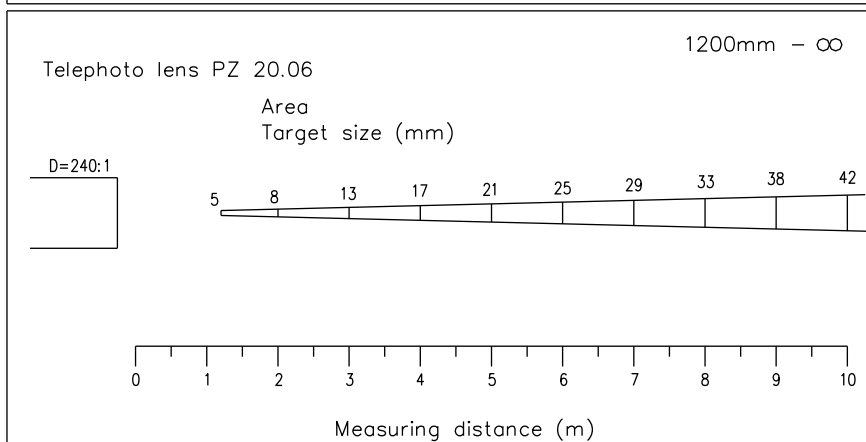
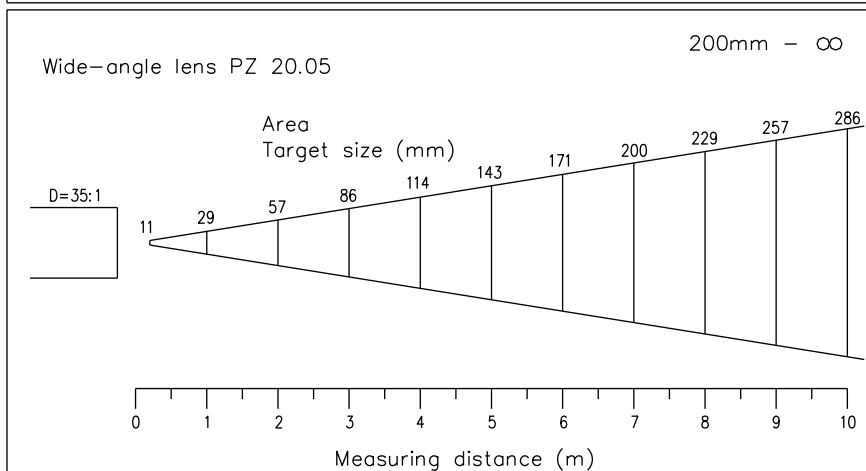
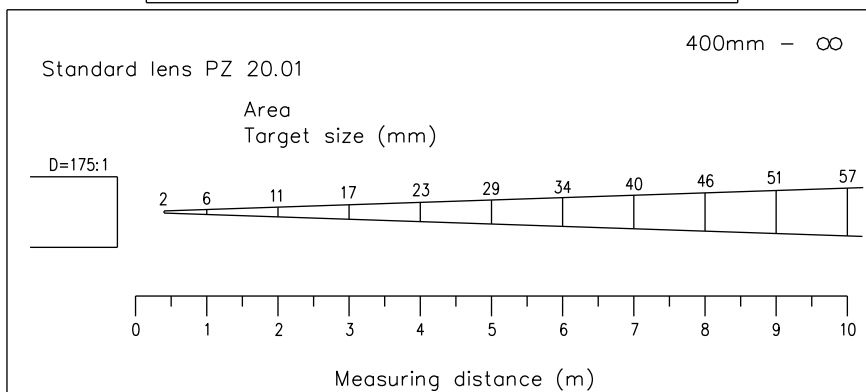
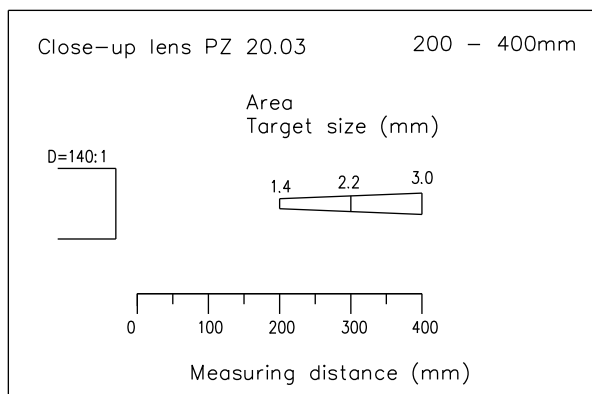

## 14 Technical Data PZ 27 AF 410

### Measuring ranges (adjustable in partial ranges):

100 to 800 °C (Ta=0 to 30 °C)  
120 to 800 °C (Ta=0 to 50 °C)

### Sensors:

photodiode

### Spectral sensitivity:

1.8 to 2.2 µm

### Focussing range:

0.3 m to ∞

### Distance to target-size ratio:

40 : 1  
(at 90 % enclosed energy)  
35 : 1  
(at 95 % enclosed energy)

### Response time $t_{98}$ :

≤ 40 ms for  $T \geq 120$  °C  
≤ 60 ms for  $T \geq 100$  °C

### Linearization:

digital via microcontroller

### Measuring Uncertainty:

0.75 % of measured value,  
at least 5 K;  
(at  $\varepsilon = 1.0$  and Ta 23 °C  
at smoothing  $t_{98} \geq 3$  sec.)

### Repeatability:

2 K  
at smoothing  $t_{98} \geq 3$  sec.

### Resolution:

≤ 0.8 K  
at smoothing  $t_{98} \geq 3$  sec.

### Sighting device:

through-the-lens sighting with  
target marking

### Ambient operating temperature range:

0 to 50 °C

### Storage temperature range:

-20 to 70 °C

### Permissible humidity:

95% r.H. max.  
(non-condensing)

### Temperature coefficient with reference to 23 °C:

0,25 K / K (for  $T < 500$  °C)  
0,05 % / K (for  $T \geq 500$  °C)  
of measured value  
(at  $\varepsilon = 1.0$  and Ta 23 °C)

### Interface:

PROFIBUS DP with extension  
for DPV1 Certified by the  
PNO (Profibus user's organi-  
sation) Certificate  
No.: Z00704

max. transmission rate:  
12 MBaud

### Device address:

0 to 99  
adjustable about switches

### Power supply require- ments:

22 - 27 V DC / ≤ 80 mA  
Ripple: ≤ 200 mV

### Dimensions:

φ 65 x 200 mm

### Housing material:

aluminium

### Connection:

terminal clamp  
(PROFIBUS Norm)

### Weight:

≤ 0.8 kg

### Protection:

IP 65 according to DIN 40050

### Adjustable parameters:

#### retrievable measured values:

temperature spectral  
cannel 1  
device temperature

#### Adjustable parameters:

Emissivity Coefficient  
Smoothing function  
Peak-picker

#### Optional accessories:

calibration certificate  
according to ISO 9001

calibration certificate  
according to DKD

large variety of mounting  
devices digital displays,  
software, etc.

### 14.1 Target diagram PZ 27 AF 410

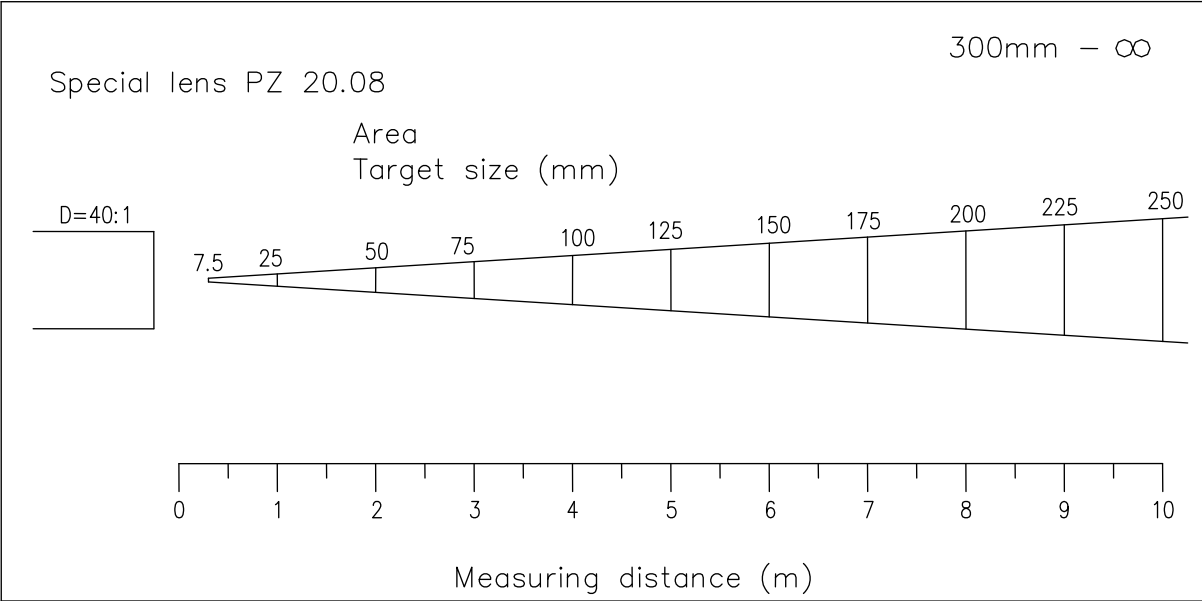

## 15 Technical Data PZ 27 AF 421 - 423

### Measuring ranges (adjustable in partial ranges):

150..1200 °C (at  $\varepsilon > 0,5$ )  
180°C for  $\varepsilon > 0,1$   
)

### Sensors:

photodiode

### Spectral sensitivity:

1.8 to 2.2  $\mu\text{m}$

### Focussing range:

PZ27AF421 0.4m ...  $\infty$   
PZ27AF422 0.2...0.4m  
PZ27AF423 1.2m ...  $\infty$

### Distance to target-size ratio:

PZ27AF421 60:1  
PZ27AF422 56:1  
PZ27AF423 96:1  
(at 90 % enclosed energy)

### Response time $t_{98}$ :

$\leq 40$  ms for  $T \geq 150^\circ\text{C}$   
(at  $\varepsilon = 1.0$ ; smoothing off)

### Linearization:

digital via microcontroller

### Measuring Uncertainty:

0.75 % of measured value,  
at least 5 K;  
(at  $\varepsilon = 1.0$  and  $T_A = 23^\circ\text{C}$   
at smoothing  $t_{98} \geq 300$  ms)

### Repeatability:

2 K  
at smoothing  $t_{98} \geq 300$  ms

### Resolution:

$\leq 1.0$  K  
(at  $\varepsilon = 1.0$ ,  $T_A = 23^\circ\text{C}$  and  
at smoothing  $t_{98} \geq 300$  ms)

### Sighting device:

through-the-lens sighting with  
target marking

### Ambient operating temperature range:

0 to 50 °C

### Storage temperature range:

-20 to 70 °C

### Permissible humidity:

95% r.H. max.  
(non-condensing)

### Temperature coefficient with reference to 23 °C:

0,25 K / K (for  $T < 500^\circ\text{C}$ )  
0,05 % / K (for  $T \geq 500^\circ\text{C}$ )  
of measured value  
 $T_A = 23^\circ\text{C}$

### Interface:

PROFIBUS DP with extension  
for DPV1 Certified by the  
PNO (Profibus user's organi-  
sation) Certificate  
No.: Z00704

max. transmission rate:  
12 MBaud

### Device address:

0 to 99  
adjustable about switches

### Power supply require- ments:

22 - 27 V DC /  $\leq 80$  mA  
Ripple:  $\leq 200$  mV

### Dimensions:

$\phi$  65 x 200 mm

### Housing material:

aluminium

### Connection:

terminal clamp  
(PROFIBUS Norm)

### Weight:

$\leq 0.8$  kg

### Protection:

IP 65 according to DIN 40050

### Adjustable parameters:

#### retrievable measured values:

temperature spectral  
cannel 1  
device temperature

#### Adjustable parameters:

Emissivity Coefficient  
Smoothing function  
Peak-picker

#### Optional accessories:

calibration certificate  
according to ISO 9001

calibration certificate  
according to DKD

large variety of mounting  
devices digital displays,  
software, etc.

### 15.1 Field of View Diagrams for PA 29 AF 421 – 423

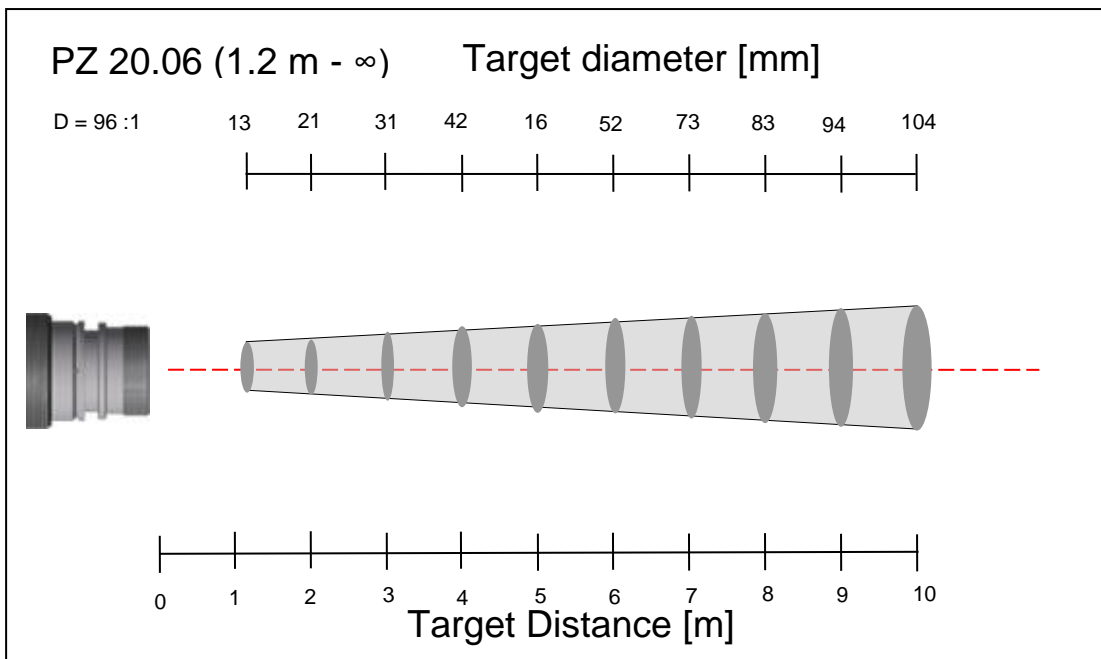
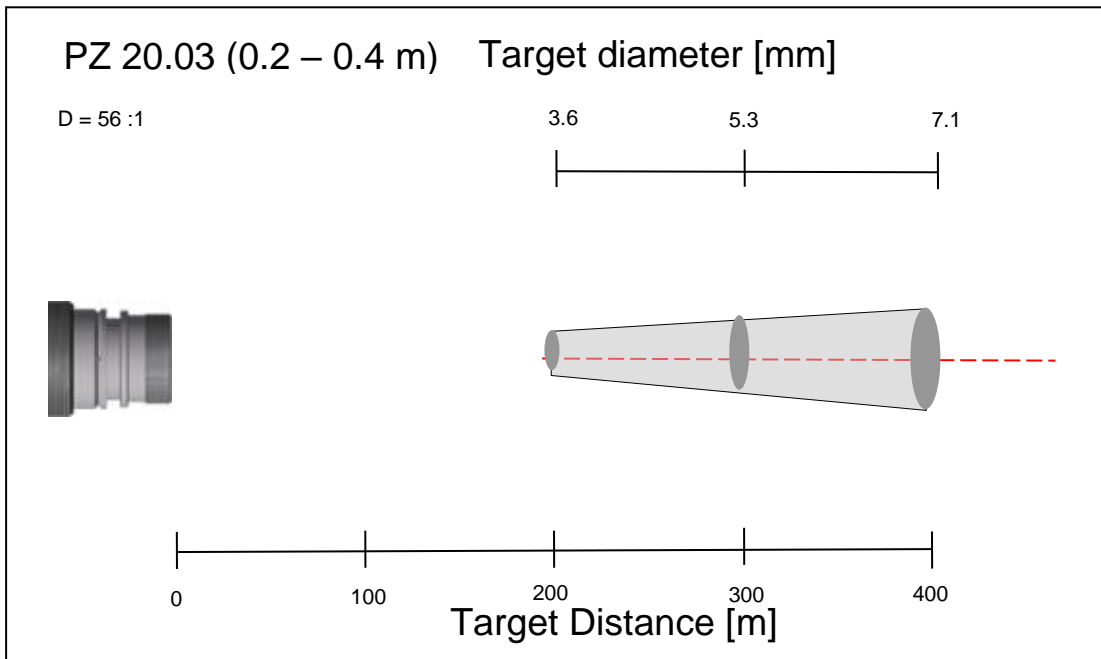

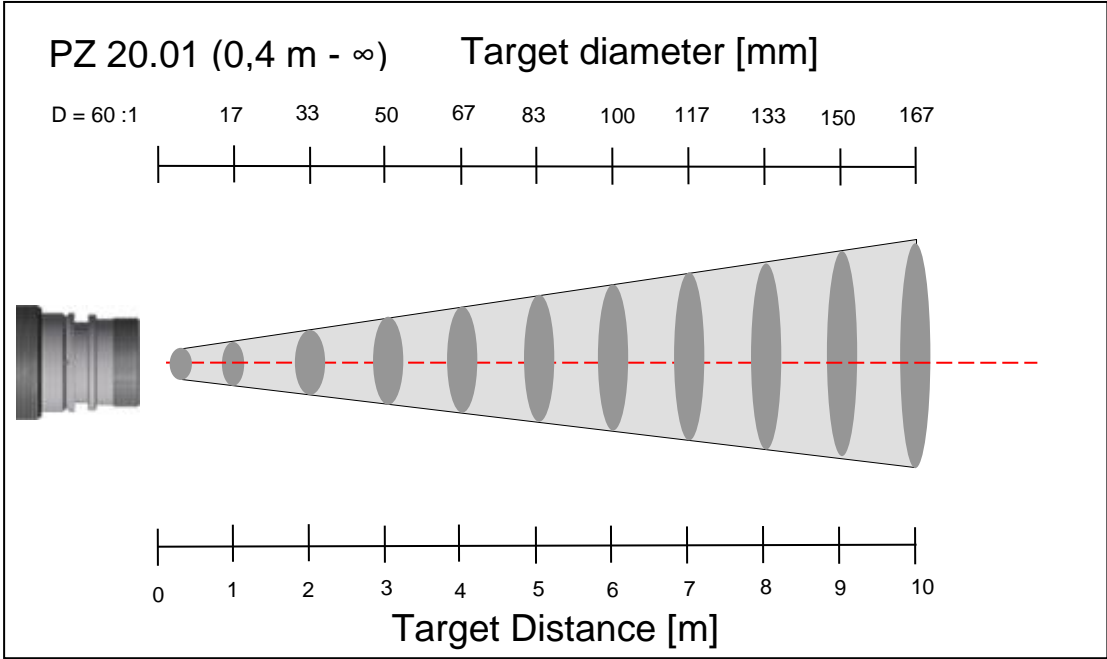

## 16 Technical Data PZ 21 / 31

**Measuring ranges (adjustable in partial ranges):**

**PZ 21:** 350 to 2000 °C  
**PZ 31:** 800 to 2500 °C

**Sensors:**  
photo diode

**Spectral sensitivity:**  
**PZ 21:** 1.1 to 1.7 µm  
**PZ 31:** 0.8 to 1.1 µm

**Focussing ranges M30:**  
0.15 m to ∞ (standard lens)  
0.40 m to ∞ (long distance lens)  
0.07 m to 0.1 (close-up lens)

**Distance to target size ratio M30:**

80 : 1 (standard lens)  
120 : 1 (long-distance lens)  
50 : 1 (short-distance lens)

**Focussing ranges M16:**  
0.12 m to ∞ (standard lens)  
33 ... 44 mm (close-up lens)

**Distance to target size ratio M16:**

100 : 1 (standard lens)  
50 : 1 (short-distance lens)

**Fibre optic waveguide:**

quartz fibre, can be screwed off at both sides, length and design are variable

**Response time t<sub>98</sub>:**

**PZ 21:** ≤ 40 ms for T ≥ 1000 °C  
**PZ 31:** ≤ 40 ms for T ≥ 1200 °C

**Resolution:**

≤ 1 K  
(if smoothing is ≥ 80 ms)

**Linearization:**

digital via microcontroller

**Measuring uncertainty:**

1 % of measured value  
(at ε = 1.0 and T<sub>a</sub> 23 °C)

**Repeatability:**

2 K

**Sighting device:**

aiming spot

**Ambient operating temperature range:**

sensor: -20 to 250 °C  
fibre optic cable: -20 to 85 °C  
optional up to 250 °C  
electronic: 0 to 60 °C

**Storage temperature range:**

sensor: -20 to 250 °C  
fibre optic cable: -20 to 85 °C  
optional up to 250 °C  
electronic: -20 to 70 °C

**Permissible humidity:**

95% r.H. max.  
(non-condensing)

**Temperature coefficient with reference to 23 °C:**

0.25 K / K (for T < 500 °C)  
0.05 % / K (for T > 500 °C)  
of measured value

**Interface:**

PROFIBUS DP with extension for DPV1 Certified by the PNO (Profibus user's organisation) Certificate No.: Z00704

max. transmission rate:  
12 MBaud

**Device address:**

0 to 99  
adjustable about switches

**Power supply requirements:**

22 - 27 V DC / ≤ 100 mA  
if the Laser spot is switched on, respectively  
Ripple: ≤ 200 mV

**Dimensions:**

sensor: φ 30 x 75 mm  
(length depending on the measuring distance)  
electronic: φ 65 x 160 mm

**Housing material:**

aluminium  
sensor: high-grade steel

**Connection:**

terminal clamp  
(PROFIBUS Norm)

**Weight:**

≤ 0.6 kg

**Protection:**

IP 65 according to DIN 40050

**Adjustable parameters retrievable measured values:**

temperature spectral  
cannel 1  
device temperature

**Adjustable parameters:**

Emissivity Coefficient  
Smoothing function  
Peak-picker

**Optional accessories:**

calibration certificate:  
according to ISO 9001

calibration certificate:  
according to DKD

large variety of mounting devices, digital displays, software, etc.

## 16.1 Target Diagram PZ 21 / 31

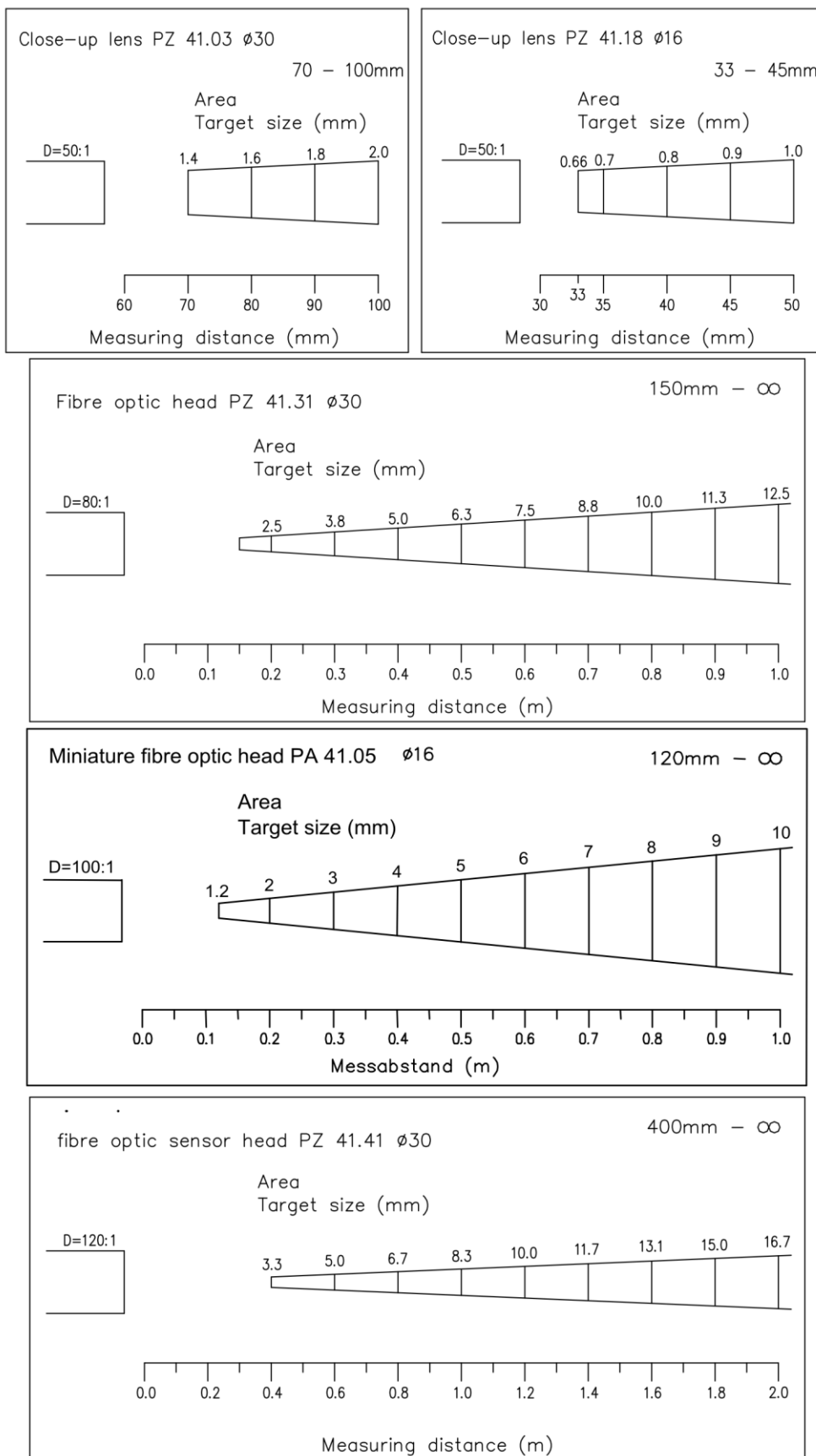



## 17 Technical Data PZ 40

### Measuring ranges

(adjustable in partial ranges):

700 to 1600 °C  
900 to 2400 °C  
1000 to 3000 °C

### Extended measuring ranges

for  $\epsilon > 0.5$ :

650 to 1600 °C  
800 to 2400 °C  
900 to 3000 °C

### Sensor:

photodiode

### Spectral sensitivity:

0.95 / 1.05  $\mu\text{m}$

### Distance to target-size ratio:

$T_{\text{anf}}$	$\approx 700^\circ\text{C}$	$> 900^\circ\text{C}$
Close-up	75:1	140:1
Stand. lens	80:1	150:1
Wide angle	17:1	35:1
Tel. lens	120:1	240:1

### Focussing range:

0.2 to 0.4 m (close-up lens)  
0.4 m to  $\infty$  (standard lens)  
1.2 m to  $\infty$  (telephoto lens)  
0.2 m to  $\infty$  (wide-angle lens)

### Response time $t_{98}$ :

$\leq 100$  ms

### Resolution:

$\leq 1.5$  K  
(if smoothing is  $\geq 80$  ms and  $T_a = 23^\circ\text{C}$ )

### Linearization:

digital via microcontroller

### Measuring uncertainty:

1 % of measured value  
(at  $\epsilon = 1.0$  and  $T_a 23^\circ\text{C}$ )

### Repeatability:

2 K

### Sighting device:

through-the-lens sighting with target marking

### Ambient operating Temperature range:

0 to  $60^\circ\text{C}$

### Storage temperature range:

$-20$  to  $70^\circ\text{C}$

### Permissible humidity:

95% r.H. max.  
(non-condensing)

### Temperature coefficient with reference to $23^\circ\text{C}$ :

0.05 % of measured value

### Interface:

PROFIBUS DP with extension for DPV1 Certified by the PNO (Profibus user's organisation) Certificate No.: Z00704

max. transmission rate:  
12 MBaud

### Device address:

0 to 99  
adjustable about switches

### Power supply requirements:

22 - 27 V DC /  $\leq 80$  mA  
Ripple:  $\leq 200$  mV

### Dimensions:

$\phi 65 \times 200$  mm

### Housing material:

aluminium

### Connection:

terminal clamp  
(PROFIBUS Norm)

### Weight:

$\leq 0.8$  kg

### Protection:

IP 65 according to DIN 40050

### Adjustable parameters:

#### retrievable measured values:

temp. spectral channel 1  
temp. spectral channel 2  
temp. quotient  
signalstrength quotient  
device temperature

### Adjustable parameters:

Setting of  $\frac{\epsilon_1}{\epsilon_2}$

Setting of the  $\epsilon$  factor (spektral channel)  
Smoothing function  
Peak-picker  
Cutoffsignal strength

### Optional accessories:

calibration certificate:  
according to ISO 9001

calibration certificate:  
according to DKD

large variety of mounting devices digital displays, software, etc.

### 17.1 Target Diagram PZ 40

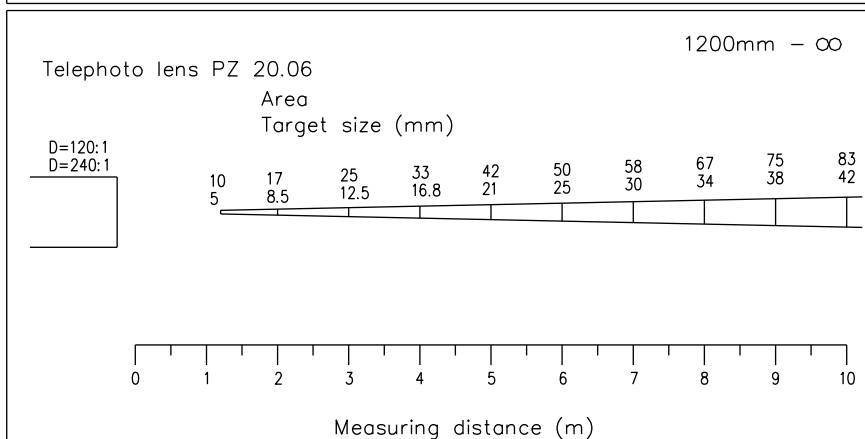
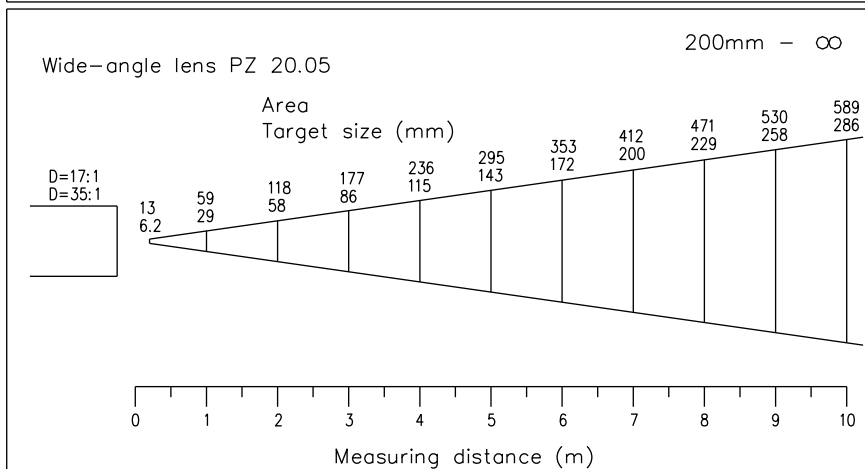
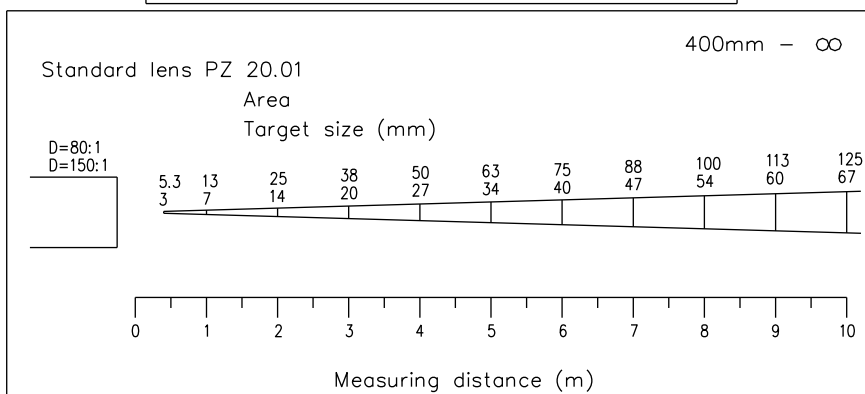
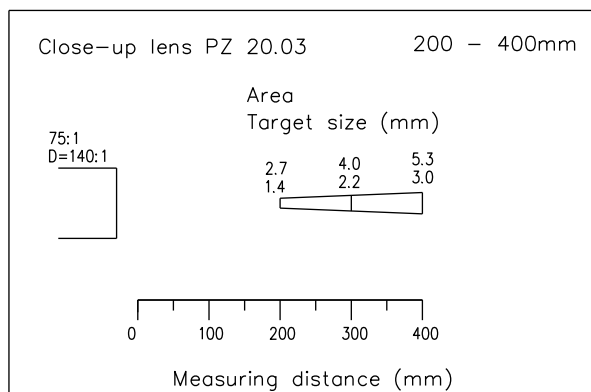

## 18 Technical Data PZ 41

Measuring ranges (adjustable in partial ranges): 700 – 1800 °C 900 to 2400 °C 1000 to 3000 °C	Measuring uncertainty: 1,5 % of measured value (at $\varepsilon = 1.0$ and $T_a 23\text{ °C}$ )	Dimensions: sensor: $\phi$ 30 x 75 mm (length depending on the measuring distance) electronic: $\phi$ 65 x 160 mm
Extended measuring ranges for $\varepsilon > 0.5$ : 800 to 2400 °C 900 to 3000 °C	Repeatability: 3 K	Housing material: aluminium sensor: high-grade steel
Sensor: photodiode	Sighting device: Laser spot	Connection: terminal clamp (PROFIBUS Norm)
Spectral sensitivity: 0.95 / 1.05 $\mu\text{m}$	Ambient operating temperature range: sensor: - 20 to 250 °C fibre optic cable:- 20 to 85 °C optional up to 250 °C electronics: 0 to 60 °C	Weight: $\leq 0.8\text{ kg}$
Focussing ranges: 0.15 m to $\infty$ (PZ 41.31/61) 0.40 m to $\infty$ (PZ 41.41/51) 0.07m to 0.1 m (PZ 41.03) 0.12 m to $\infty$ (PA 41.05) 0.12 m to $\infty$ (PZ 41.29) 0.033 m to 0.045 m (PZ 41.18/19)	Storage temperature range: sensor: - 20 to 250 °C fibre optic cable: - 20 to 85 °C optional up to 250 °C electronics: -20 to 70 °C	Protection: IP 65 according DIN 40050
Distance to target size ratio: 80 : 1 (PZ 41.31/61) 120 : 1 (PZ 41.41/51) 50 : 1 (PZ 41.03) 50 : 1 (PZ 41.29) 100 : 1 (PA 41.05) 50 : 1 (PA 41.05)* 50 : 1 (PZ 41.18/19)	Permissible humidity: 95% r.H. max. (non-condensing)	Adjustable parameters:  retrievable measured values: temp. spectral channel 1 temp. spectral channel 2 temp. quotient signalstrength quotient device temperature
Fibre optic waveguide: quartz fibre, can be screwed off at both sides, length and design are variable	Temperature coefficient with reference to 23 °C : 0.05 % of reading / K	Adjustable parameters:  $\frac{\varepsilon_1}{\varepsilon_2}$ Setting of $\varepsilon_2$ Setting of the $\varepsilon$ factor (spektral channel) Smoothing function Peak-picker Cutoffsignal strength
Response time $t_{98}$ : $\leq 100\text{ ms}$	Interface: PROFIBUS DP with extension for DPV1 Certified by the PNO (Profibus user's organisation) Certificate No.: Z00704	Optional accessories: calibration certificate: according to ISO 9001  calibration certificate: according to DKD
Resolution: $\leq 2.0\text{ K}$ (if smoothing is $\geq 80\text{ ms}$ and $T_a 23\text{ °C}$ )	max. transmission rate: 12 MBaud	large variety of mounting devices, digital displays, soft- ware, etc.
Linearization: digital via microcontroller	Device address: 0 to 99 adjustable about switches	
*measure range 700 -1800 °C	Power supply: 22 - 27 V DC / $\leq 80\text{ mA}$ or $\leq 180\text{ mA}$ if the laser spot is switched on, respectively Ripple $\leq 200\text{ mV}$	

## 18.1 Target Diagram PZ 41

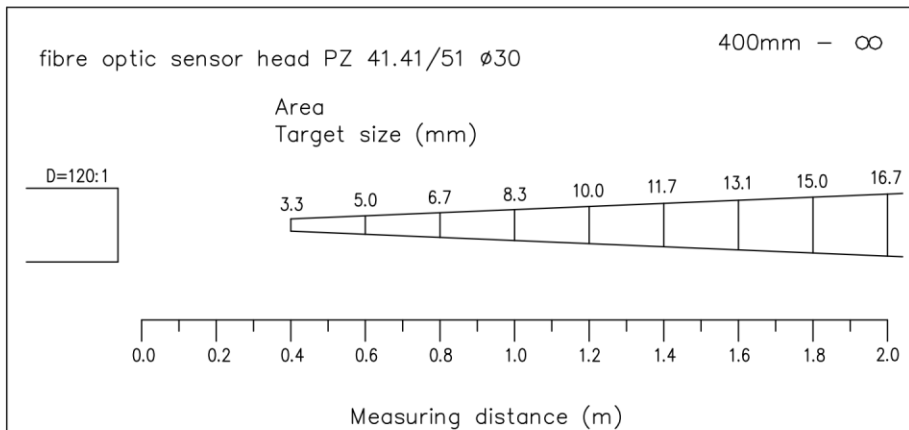
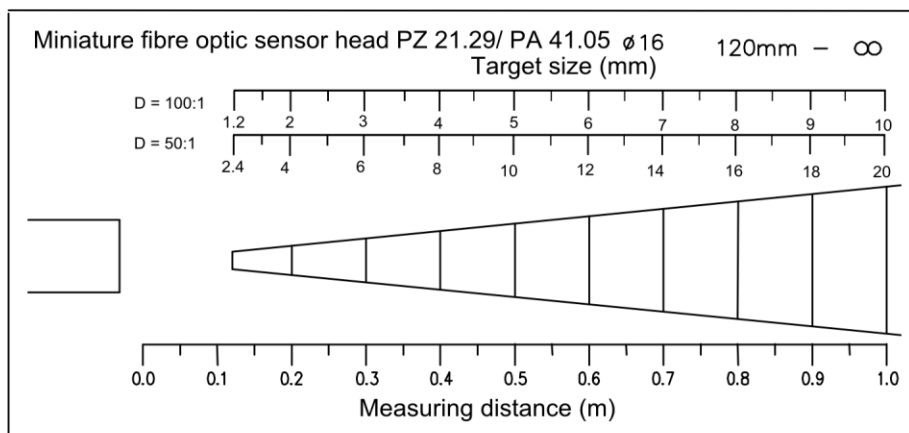
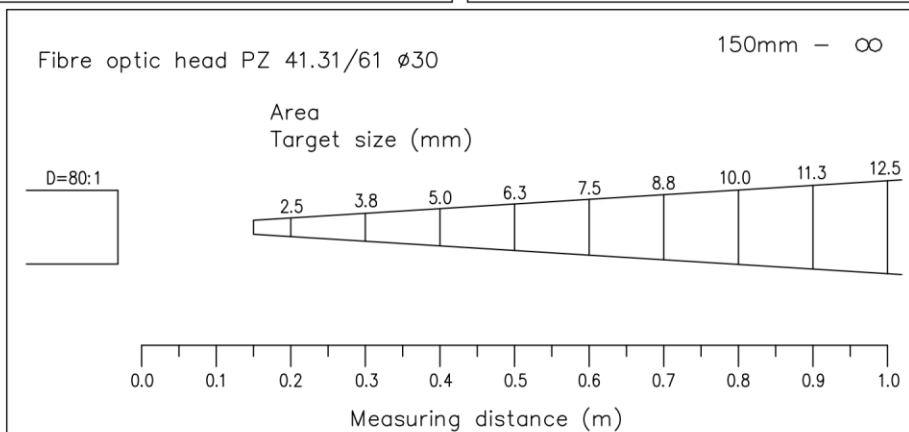
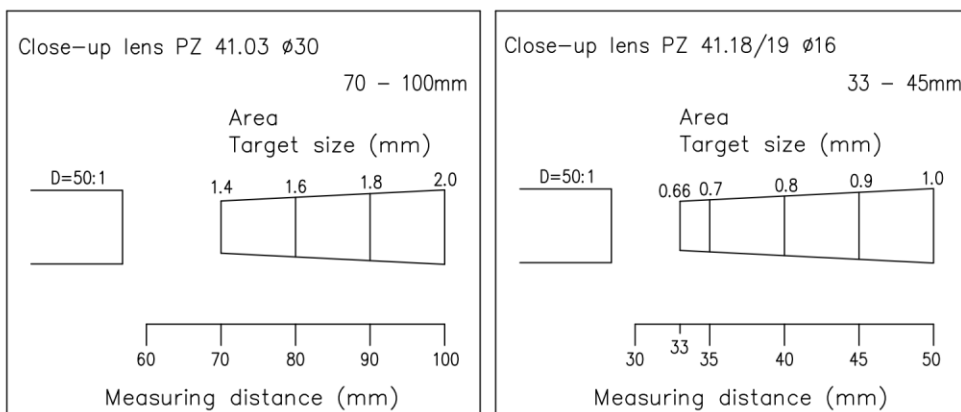

## 19 Technical Data Technical Data PZ 50

**Measuring ranges (adjustable in partial ranges):**  
500 to 1400 °C

**Sensor:**  
photodiode

**Spectral sensitivity:**  
0.95 µm / 1.55 µm

**Focussing ranges:**  
0.2 to 0,4 m (close-up lens)  
0.4 m to ∞ (standard lens)  
0.2 m to ∞ (wide - angle lens)  
1.2 m to ∞ (telephoto lens)

**Distance to target size ratio:**

75 : 1 (close-up lens)  
80 : 1 (standard lens)  
15 : 1 (wide - angle lens)  
120 : 1 (telephoto lens)

**Response time  $t_{98}$ :**  
≤ 100 ms

**Resolution:**  
≤ 1.5 K  
(if smoothing is ≥ 80 ms and  $T_a = 23\text{ °C}$ )

**Linearization:**  
digital via microcontroller

**Measuring uncertainty:**  
1.0 % of measured value  
(at  $\varepsilon = 1.0$  and  $T_a 23\text{ °C}$ )

**Repeatability:**  
2 K

**Sighting device:**  
through-the-lens sighting with target marking

**Ambient operating temperature range:**  
0 to 60 °C

**Storage temperature range:**  
- 20 to 70 °C

**Permissible humidity:**  
95% r.H. max.  
(non-condensing)

**Temperature coefficient with reference to 23 °C:**  
0.05 % of reading / K

**Interface:**  
PROFIBUS DP with extension for DPV1 Certified by the PNO (Profibus user's organisation) Certificate No.: Z00704

max. transmission rate:  
12 MBaud

**Device address:**  
0 to 99  
adjustable about switches

**Power supply requirements:**  
22 - 27 V DC / ≤ 80 mA  
Ripple: ≤ 200 mV

**Dimensions:**  
φ 65 x 200 mm

**Housing material:**  
aluminium

**Connection:**  
terminal clamp  
(PROFIBUS Norm)

**Weight:**  
≤ 0.8 kg

**Protection:**  
IP 65 according to DIN 40050

**Adjustable parameters:**

**retrievable measured values:**

temp. spectral channel 1  
temp. spectral channel 2  
temp. quotient  
signalstrength quotient  
device temperature

**Adjustable parameters:**

Setting of  $\frac{\varepsilon_1}{\varepsilon_2}$   
Setting of the  $\varepsilon$  factor (spektral channel)  
Smoothing function  
Peak-picker  
Cutoffsignal strength

**Optional accessories:**  
calibration certificate:  
according to ISO 9001

calibration certificate:  
according to DKD

large variety of mounting devices, digital displays, software, etc.

### 19.1 Target diagram PZ 50

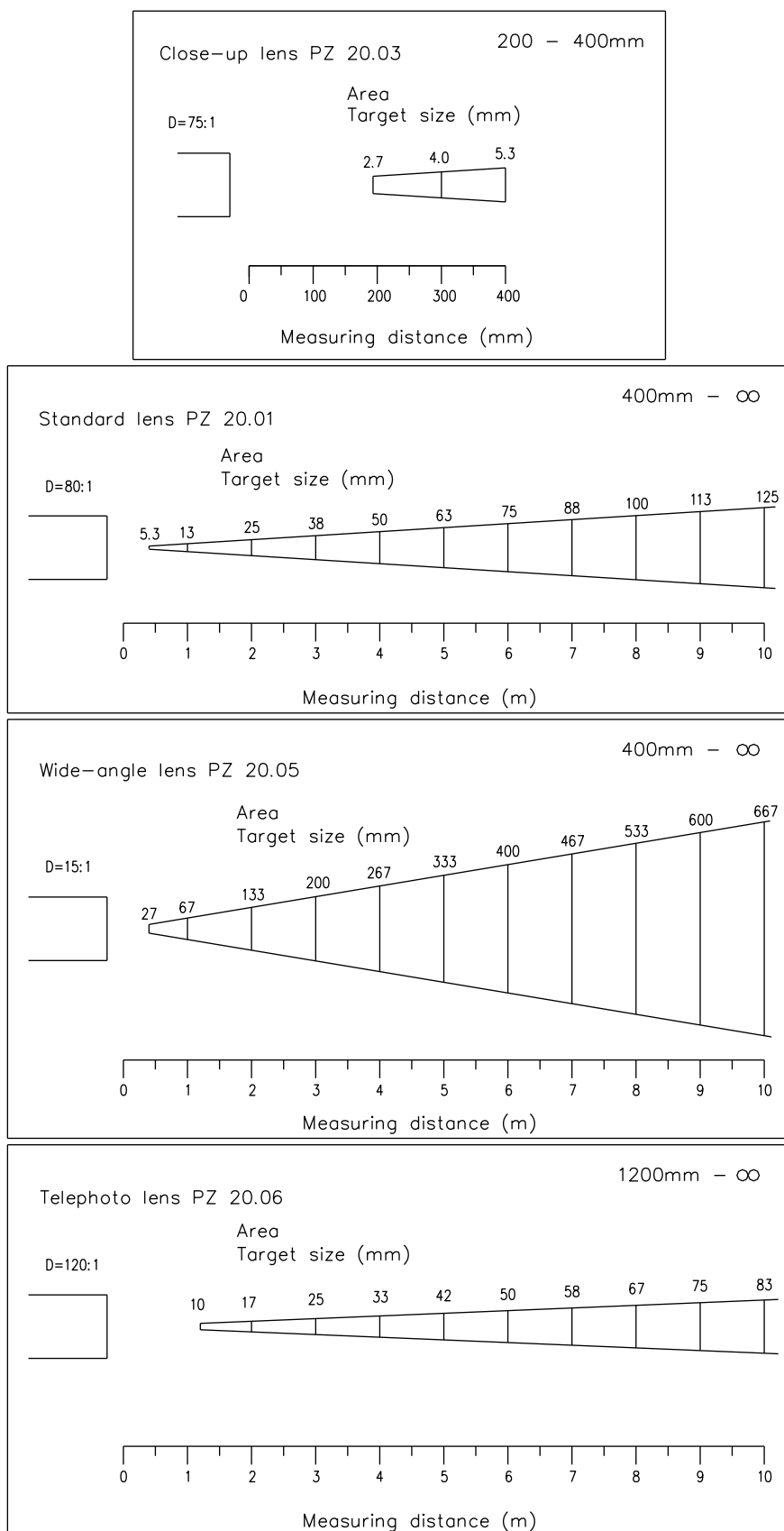

## 20 Technical Data PZ 60

**Measuring ranges (adjustable in partial ranges):**

300 to 800 °C at  $\varepsilon > 50\%$   
at 385 °C at  $\varepsilon > 10\%$   
(and  $T_u = 23\text{ °C}$ )

**Sensor:**  
photodiode

**Spectral sensitivity:**  
1.2 - 1.7  $\mu\text{m}$  / 1.7 - 2.2  $\mu\text{m}$

**Focussing ranges:**  
0.30 m to  $\infty$

**Distance to target size ratio:**  
45 : 1 (@ 90 % of maximum detectable energy)

**Response time  $t_{98}$ :**  
 $\leq 100\text{ ms}$  for  $T \geq 350\text{ °C}$   
(at  $\varepsilon = 1,0$ ; smoothing off)

**Resolution:**  
 $\leq 1.0\text{ K}$   
(if smoothing is  $\geq 80\text{ ms}$  and  $T_a = 23\text{ °C}$ )

**Linearization:**  
digital via microcontroller

**Measuring uncertainty:**  
1.0 % of measured value  
(at  $\varepsilon = 1.0$  and  $T_a 23\text{ °C}$ )

**Repeatability:**  
2 K

**Sighting device:**  
through-the-lens sighting with target marking

**Ambient operating temperature range:**  
0 to 45 °C

**Storage temperature range:**  $\leq 0.8\text{ kg}$   
- 20 to 70 °C

**Permissible humidity:**  
95% r.H. max.  
(non-condensing)

**Temperature coefficient with reference to 23 °C:**  
0.07 % of reading / K

**Interface:**  
PROFIBUS DP with extension for DPV1 Certified by the PNO (Profibus user's organisation) Certificate No.: Z00704

max. transmission rate:  
12 MBaud

**Device address:**  
0 to 99  
adjustable about switches

**Power supply requirements:**  
22 - 27 V DC /  $\leq 80\text{ mA}$   
Ripple:  $\leq 200\text{ mV}$

**Dimensions:**  
 $\phi 65 \times 200\text{ mm}$

**Housing material:**  
aluminium

**Connection:**  
terminal clamp  
(PROFIBUS Norm)

**Weight:**

**Protection:**  
IP 65 according to DIN 40050

**Adjustable parameters:**

**retrievable measured values:**

temp. spectral channel 1  
temp. spectral channel 2  
temp. quotient  
signalstrength quotient  
device temperature

**Adjustable parameters:**

Setting of  $\frac{\varepsilon_1}{\varepsilon_2}$   
Setting of the  $\varepsilon$  factor (spektral channel)  
Smoothing function  
Peak-picker  
Cutoffsignal strength

**Optional accessories:**  
calibration certificate:  
according to ISO 9001

calibration certificate:  
according to DKD

large variety of mounting devices, digital displays, software, etc.

### 20.1 Target diagram PZ 60

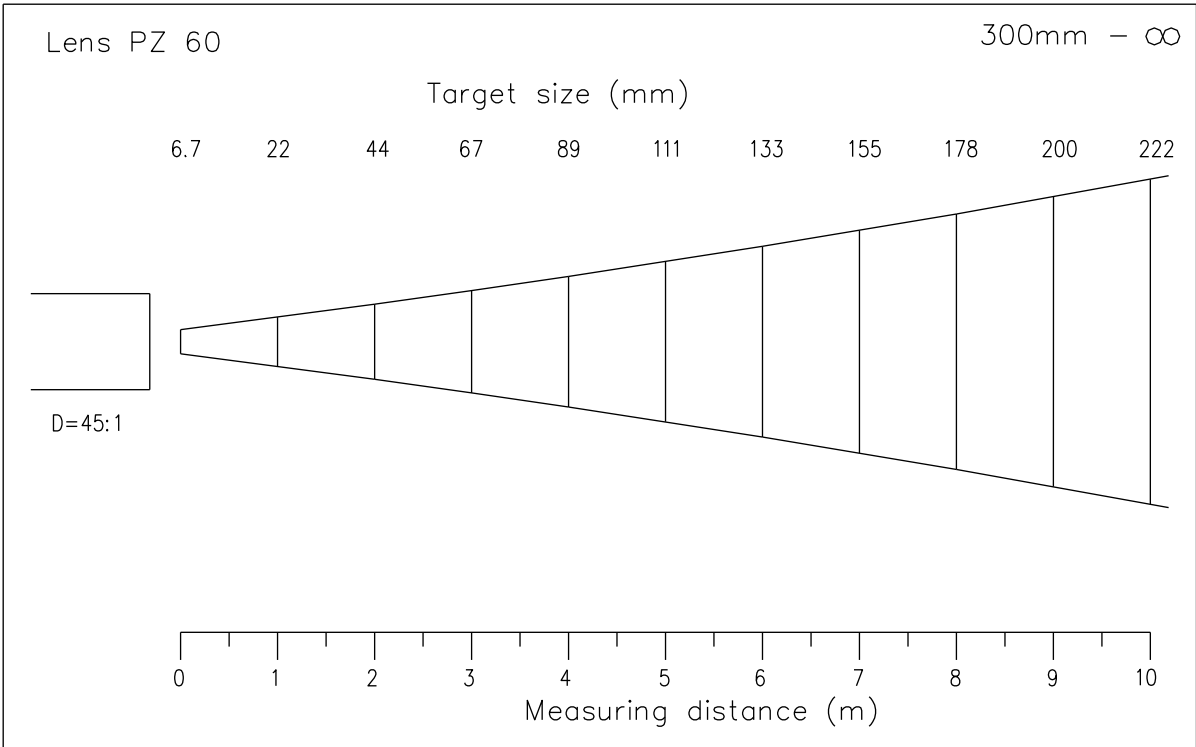



## 21 Dimensional Drawings

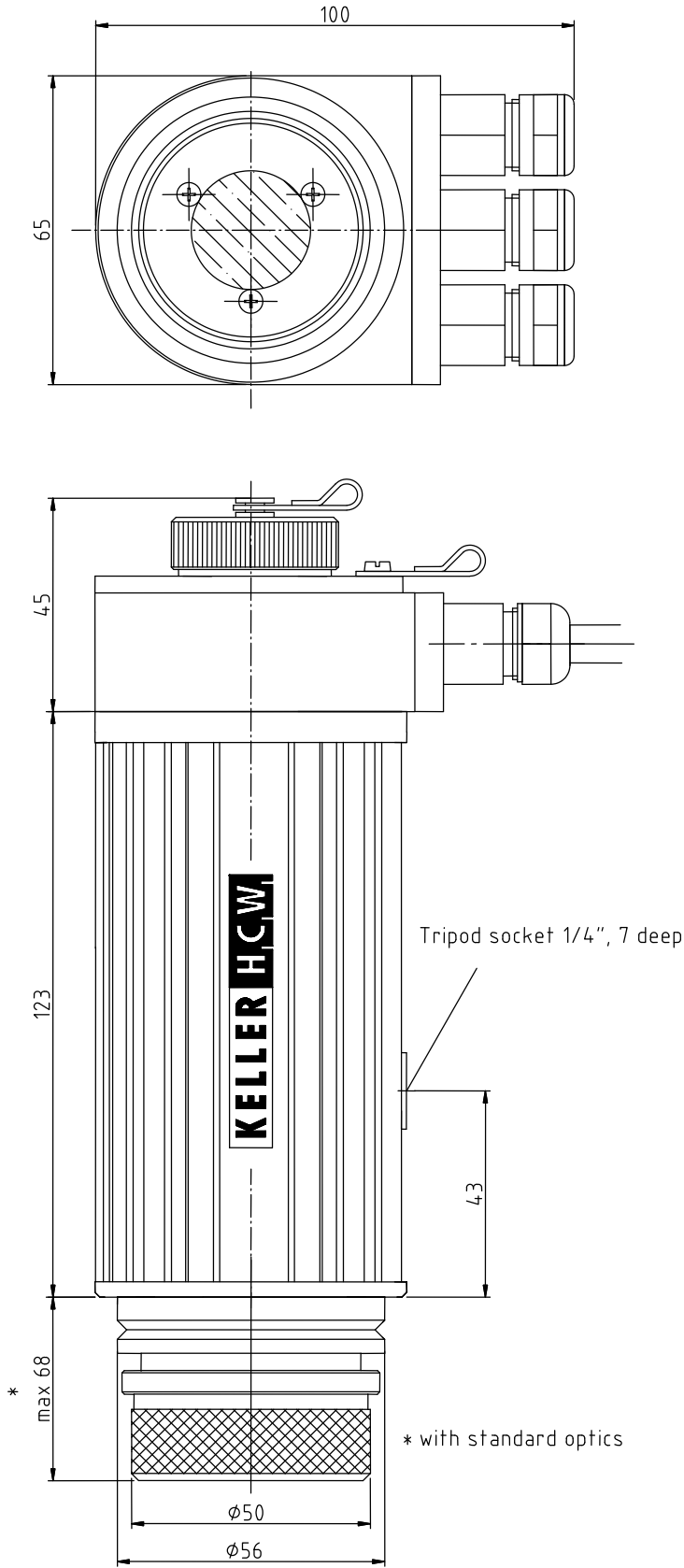

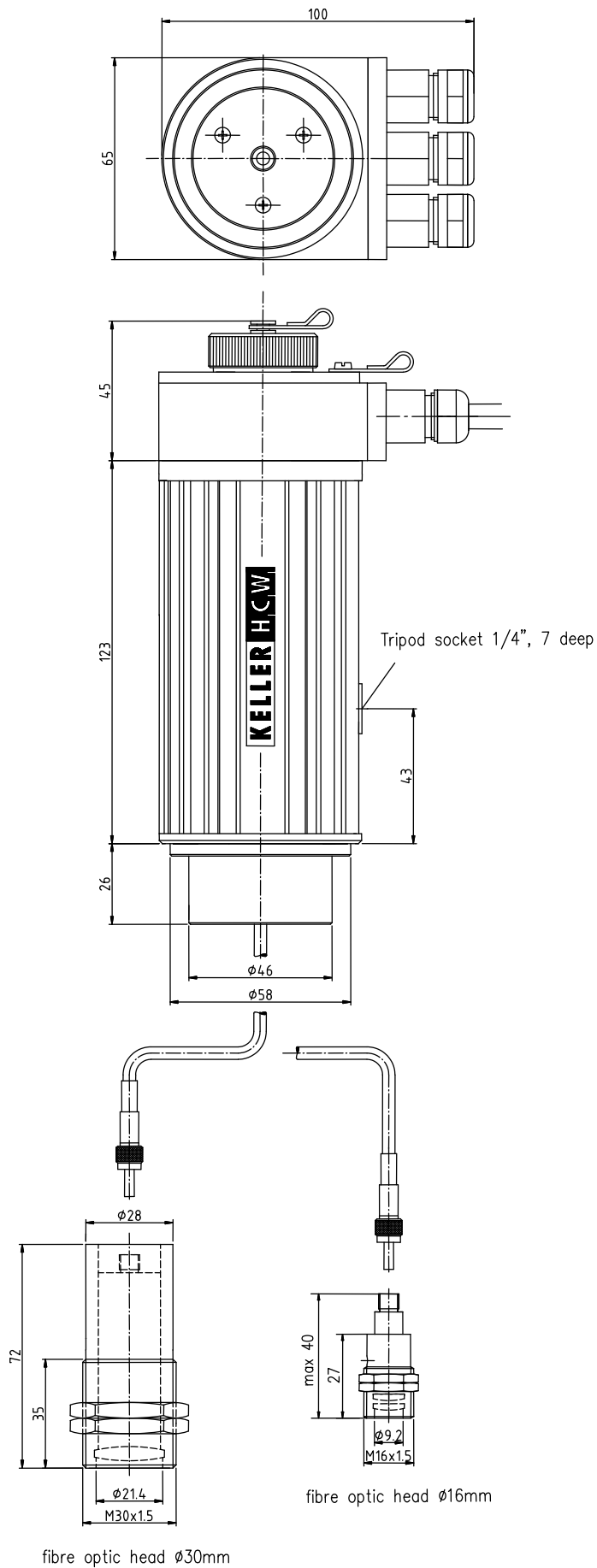

## 22 Terminal Pin Assignment

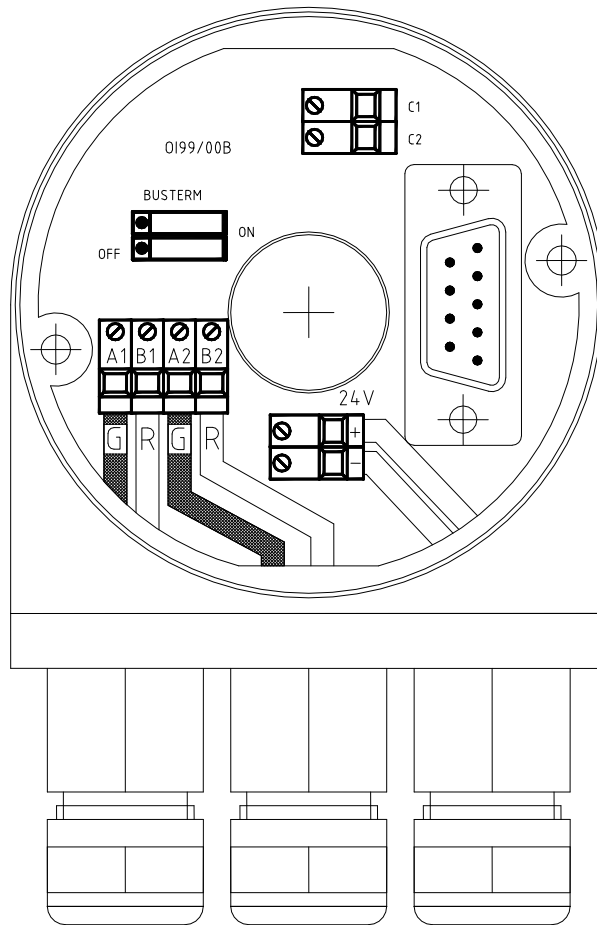

Profibus cable length (standard 5 m ) ID No. 119 214

### 22.1 Recommendation of mounting

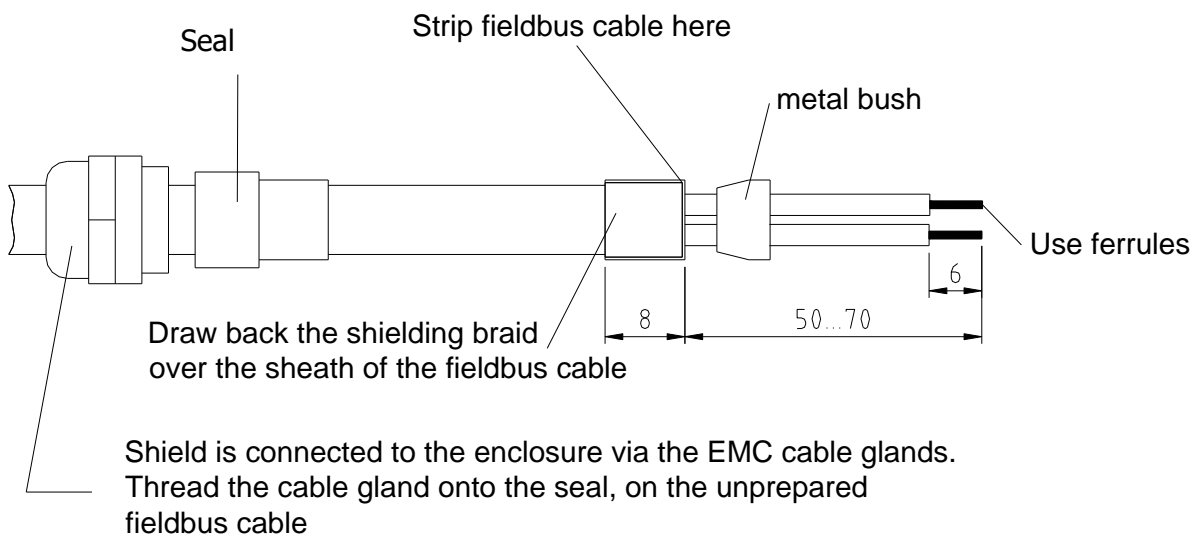

## 23 Glossary

<b>Automatic print</b>	After connecting the power supply the pyrometer starts transmitting the measured values via the serial interface automatically.
<b>Cycle timer</b>	The cycle time for the temperature output via the serial interface
<b>Distance to target size ratio</b>	Describes the ratio between the pyrometer to-object distance and the target diameter.
<b>Double Max Memory</b>	Short temperature peaks will be held for an adjustable holding time.
<b>Emissivity</b>	Ratio between the real radiation intensity of the object to the maximum theoretically possible radiation intensity at the same temperature. The epsilon needs to be adjusted at the pyrometer to correct the measured value.
<b>Hold time</b>	Old time for the mode „double peak picker holding time“
<b>Two-colour pyrometer</b>	Special kind of pyrometer which records two measurements at the same time at two different wavelengths and by means of this ratio calculates the object temperature.
<b>One colour pyrometer</b>	Radiation pyrometer, which determines the temperature by receiving a certain intensity of infrared radiation.

## 24 Shipping, Packaging and Disposal

### Inspecting your shipment

Unpack and inspect the entire shipment immediately upon receipt to make sure it is complete and undamaged.

If the container/package shows visible signs of damage, please refuse the shipment. If this is not possible, accept the shipment on the condition that the freight carrier's delivery record is noted with the extent of the damage in order to file a claim.

### Concealed damages

Should you discover a concealed loss or damage, report it to KELLER and to the freight carrier immediately. If the period for filing claims has expired, you will no longer be able to make any claims for compensation of damage or loss.

### Packaging

The packages used by KELLER are made of carefully selected, environmentally compatible materials and are thus recyclable.

### Disposal of used apparatus

Used electrical and electronic equipment often contain valuable components. The owner/user may either return such an instrument to the manufacturer for disposal, or he must dispose of it himself in a professional and nonpolluting manner.

KELLER HCW will not be held accountable for any inappropriate disposal carried out by the user/owner of KELLER HCW instruments.







