

 **IO-Link**



Pyrometer
CellaCombustion
PK 62, PK 72, PK 73, PK 74

Ident no.: 1118585 06/2022

Content

| | | |
|-------|--|----|
| 1 | General | 5 |
| 1.1 | Information about this manual | 5 |
| 1.2 | Explanation of symbols | 5 |
| 1.3 | Liability and Warranty | 5 |
| 1.4 | Copyright | 6 |
| 2 | Safety | 6 |
| 2.1 | Intended use | 6 |
| 2.2 | User's responsibility | 6 |
| 2.3 | Safety requirements | 6 |
| 2.4 | Electromagnetic Compatibility | 7 |
| 3 | Determination and use | 7 |
| 3.1 | Typical measuring points | 7 |
| 4 | Models | 8 |
| 4.1 | Flame temperature measurement | 8 |
| 4.2 | CO ₂ -Measurement | 9 |
| 5 | Function | 9 |
| 5.1 | Analogue output | 9 |
| 5.2 | Switching threshold OUT1 | 10 |
| 5.2.1 | Output signal | 10 |
| 5.2.2 | Upper threshold delay | 11 |
| 5.2.3 | Lower threshold delay | 11 |
| 5.2.4 | Switching functions | 12 |
| 5.2.5 | Internal signal processing for the switching threshold | 12 |
| 5.3 | Switching threshold OUT2 (PK 62) | 12 |
| 5.3.1 | Dirt alert (PK 62) | 13 |
| 5.3.2 | Sync-pulse (PK 62) | 14 |
| 5.3.3 | Inner device temperature (PK 62) | 14 |
| 5.3.4 | Output signal (PK 62) | 14 |
| 5.3.5 | Upper threshold delay (PK 62) | 14 |
| 5.3.6 | Lower threshold delay | 14 |
| 5.4 | Setting the emissivity ratio (two-colour mode, PK 62) | 14 |
| 5.5 | Emissivity of materials (one-colour mode) | 15 |
| 5.6 | Transmission factor (one-colour mode) | 16 |
| 5.7 | IO-Link | 16 |

| | | |
|------|---|----|
| 6 | Electrical connection | 17 |
| 6.1 | CellaCombustion PK 62 | 17 |
| 6.2 | CellaCombustion PK 72 / PK 73 / PK 74 | 18 |
| 7 | Shielding and Grounding | 19 |
| 7.1 | Equipotential bonding | 19 |
| 8 | Operating controls and display | 20 |
| 9 | Menu PK 62 | 21 |
| 9.1 | Process value display | 21 |
| 9.2 | Analogue output | 21 |
| 9.3 | Digital threshold OUT1 | 22 |
| 9.4 | Digital threshold OUT2 | 23 |
| 9.5 | Two-colour mode | 24 |
| 9.6 | One-colour mode | 25 |
| 9.7 | Advanced Features | 26 |
| 10 | Menu explanation PK 62 | 27 |
| 10.1 | Analogue output | 27 |
| 10.2 | Switching threshold OUT1 | 27 |
| 10.3 | Switching threshold OUT2 | 28 |
| 10.4 | Measurement acquisition (two-colour mode) | 29 |
| 10.5 | Measurement acquisition (one-colour mode) | 30 |
| 10.6 | Advanced Features | 30 |
| 11 | Menu PK 72 / PK 73 / PK 74 | 31 |
| 11.1 | Process value display | 31 |
| 11.2 | Digital threshold OUT1 | 31 |
| 11.3 | Digital threshold OUT2 | 32 |
| 11.4 | Advanced Features | 33 |
| 12 | Menu explanation PK 72 / PK 73 / PK 74 | 34 |
| 12.1 | Digital threshold OUT1 | 34 |
| 12.2 | Analogue output OUT2 | 34 |
| 12.3 | Advanced Features | 35 |
| 13 | Setup | 36 |
| 13.1 | PK 62 (Flame temperature measurement) | 36 |
| 13.2 | PK 72 / PK 73 / PK 74 (CO ₂ measurement) | 37 |

| | | |
|------|--|----|
| 14 | Operating parameters..... | 38 |
| 14.1 | Setting parameters – general information..... | 38 |
| 14.2 | Damping function..... | 39 |
| 14.3 | Peak hold function..... | 40 |
| 14.4 | DTD function (Discontinuous Temperature Detection at PK 62)..... | 41 |
| 14.5 | Reset all parameters to factory settings..... | 43 |
| 15 | Operation..... | 43 |
| 15.1 | Ambient temperature..... | 43 |
| 15.2 | Error indications..... | 44 |
| 16 | Theory of Non-Contact Temperature Measurements..... | 44 |
| 16.1 | Advantages fo Non-Contact Temperature Measurement..... | 44 |
| 16.2 | Measurements an Black Bodies (Cavity Radiators)..... | 45 |
| 16.3 | Measurements of Real Radiators..... | 45 |
| 17 | Maintenance..... | 46 |
| 17.1 | Cleaning the pyrometer lens..... | 46 |
| 18 | Shipping, packaging and disposal..... | 47 |
| 18.1 | Inspection after shipping..... | 47 |
| 18.2 | Packaging..... | 47 |
| 18.3 | Disposal of the old devices..... | 47 |
| 19 | Accessories and mountings..... | 47 |
| 20 | General technical data..... | 48 |
| 21 | Device-specific technical data and field of view diagrams..... | 49 |
| 22 | Factory settings..... | 52 |
| 23 | Copyright..... | 55 |

1 General

1.1 Information about this manual

The Operating Manual shall enable the user to properly install the pyrometer and the required accessories.

Before starting installation, be sure to read and understand this entire manual, in particular the chapter on safety! The instructions contained in this manual, especially those concerning safety, as well as site specific regulations governing UV radiation must be complied with at all times. It is imperative to comply with the safety instructions and the accident protection regulations valid for the area of application.

1.2 Explanation of symbols

Important safety-related references in this manual are marked with a symbol.

ATTENTION

This symbol points out guidelines. If you do not observe them, the device might be damaged, malfunctioning or even fail to operate.

CAUTION

This symbol points out hints and information which should be heeded for efficient and trouble-free operation

- ▶ Action
This symbol instructs the operator to take action.
- > Reaction, Result
This symbol indicates the result of the action taken.

1.3 Liability and Warranty

All information compiled in this manual is in accordance with applicable regulations. The statements made are based on state-of-the-art technology and reflect our extensive knowledge and many years of experience.

-  Always carefully read this Operating Manual before beginning any work on or with the instrument, especially prior to installation and initial setup! The Manufacturer shall not be held liable for any damages or malfunctions arising from a disregard of the warnings and instructions contained herein.

1.4 Copyright

This Operating Manual should be treated as confidential. It is solely intended for use by persons involved with the instrument. This manual may not be made available to a third party without prior Manufacturer's consent. Please contact the Manufacturer if the need should arise.

2 Safety

This chapter outlines all important safety aspects to be considered for optimum employee protection and to ensure safe and reliable operations.

2.1 Intended use

The pyrometer is solely intended for use as described in this manual. Operational safety can only be ensured when the instrument is used for its intended purpose.



The use of the pyrometer for any other purpose beyond what is specified in this manual is prohibited. Using the instrument in any other manner will be considered as improper.

The manufacturer is only liable for damage that occurs during correct use. The prerequisite for any liability, however, is that the cause of the damage is due to a defective product and the defect in the product was caused by the manufacturer.

2.2 User's responsibility

The pyrometer may only be used when it is in perfect working condition.

2.3 Safety requirements

The instrument operates at low voltage (18 – 34 V DC). The power supply unit must conform to directive EN50178, SELV, PELV.

2.4 Electromagnetic Compatibility

The devices comply with the essential safety requirements of the Electromagnetic Compatibility Directive 2014/30/EU (EMC Act).

When connecting a power supply unit, make sure that it also conforms to these standards. Radio interference may arise if the pyrometer is interconnected with such peripheral devices which have not been properly interference-suppressed. This may necessitate additional interference suppression measures.

3 Determination and use

The pyrometers of the CellaCombustion series have been developed for non-contact temperature measurement in coal-fired power plants, waste incineration plants and other incinerators.

3.1 Typical measuring points

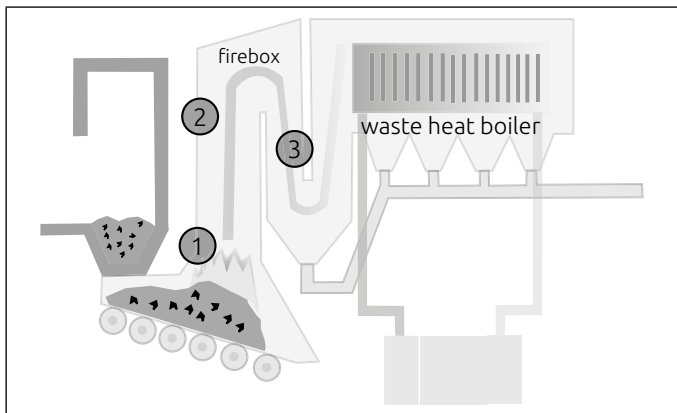

Measuring point 1: PK 62

Measuring point 2 and 3: near the wall:

PK 72 / PK 74

in the middle of the firebox: PK 73

4 Models

| Model | Temp. range | Focus distance | Measuring field size | LED spot light |
|-----------------------------|---------------|----------------|----------------------|----------------|
| Two-colour pyrometer | | | | |
| PK 62 AF 1 | 700 - 1700 °C | 1,5 m | Ø 21 mm | no |
| One-colour pyrometer | | | | |
| PK 72 AF 1 | 400 - 2000 °C | 0,4 m | Ø 7 mm | no |
| PK 73 AF 1 | 500 - 2500 °C | 0,4 m | Ø 7 mm | no |
| PK 74 AF 1 | 250 - 1700 °C | 0,4 m | Ø 7 mm | no |

4.1 Flame temperature measurement

CellaCombustion Pyrometer PK 62 for flame temperature measurement. An important aspect for optimising the combustion and for minimising the pollutant emissions in combustion plants is the knowledge of the firing chamber temperature. This can be determined in different ways. One method is the measurement of the flame temperature. The CellaCombustion PK 62 measures the temperature of the particles of a sooting flame.

The PK 62 is a two-colour pyrometer which calculates the particle temperature of the flame on the basis of the "Rössler Algorithm" from the "black temperature" of the spectral measuring value and the colour temperature of the two-colour measurement value. With this method the optical thickness of the flame and visible depth of the pyrometer are considered for calculation. This special measuring and analysing method delivers correct measuring values regardless of size and concentration of the particles. The optical density of the flame is additionally calculated by the pyrometer. It can be read on the display and transmitted to the controller via interface for further analysis of the flame characteristics or for determining the degree of absorption of the flame.

The two-colour measuring method detects the infrared radiation at two different wavelengths and calculates the quotient from the values obtained. This measuring method is suitable for measurements of objects that are partially (either sporadically or permanently) covered by other objects or a protective screen to reduce infrared radiation as well as dirt and gas in the atmosphere. Furthermore, the two-colour measuring method can be used if the object to be measured is smaller than the measuring field of the pyrometer.

4.2 CO₂ measurement

CellaCombustion Pyrometer PK 72 / PK 73 / PK 74 for the temperature measurement of hot CO₂ gases

Another method is the measurement of the temperature of the hot CO₂ combustion gases. The CellaCombustion PK 72 / PK 73 / PK 74 carries out the measurement at a special wavelength at which hot, carbon-containing combustion gases have a high optical density and thus good radiation properties.

The emissivity of the exhaust gas depends on the wavelength and temperature. As the temperature rises, the absorption band widens towards the long-wave range. For measuring hot exhaust gases in the centre of the combustion chamber, therefore, use the PK 73.

In the area close to the wall, the temperatures are significantly lower than in the centre of the combustion chamber. If this is the preferred temperature to be measured, the PK 72 / PK 74 must be used.

Since gas is not a surface reflector, but a volume emitter, a pyrometer determines an average value over the measuring depth. The measuring depth depends on the CO₂ concentration and temperature of the hot gas.



See the chapter entitled „Commissioning“ on page 36 for the parameterization of the devices.

5 Function

The pyrometer measures the temperature without contact to target.

The sensor is provided with an analog output and one (PK 72, PK 73, PK 74) or two (PK 62) open-collector switching outputs. The instrument's display panel shows the measured temperature.

- Analogue output 0/4 - 20 mA
- OUT1: Switching signal dependent on the set temperature (PK 62, PK 72, PK 73, PK 74)
- OUT2: Switching threshold dirt alert, sync-pulse or inner device temperature (PK 62)

5.1 Analogue output

The pyrometer is equipped with an analogue output 0/4...20 mA. The maximum load is 500 Ω . The output current is linear to the measured temperature. The source must be defined before the current output can be used. The following sources are available:

- PK 62: [R0] \rightarrow [R0S] = 9U0t.
- PK 72/PK 73/PK 74: [R0] \rightarrow [R0S] = SP E c.

Within the overall measuring range, the required measuring range can be set to $^{\circ}\text{C}$ or $^{\circ}\text{F}$ using parameter [R0 _] (scale beginning) and parameter [R0 ^] (scale end). There is also the possibility, to switch OUT2 between 0 - 20 mA and 4 - 20 mA.

Scale beginning [R0] \rightarrow [R0 _]

Scale end [R0] \rightarrow [R0 ^]

Change 0/4 - 20 mA [R0] \rightarrow [R004] = 0 - 20 / 4 - 20

First, the beginning of the scale [R0 _] in $^{\circ}\text{C}$ or F is entered, then the end of the scale [R0 ^]. By changing [R0 _] also changes [R0 ^], so that the range remains the same. If [R0 _] is increased so far, that the range can not be adhered to, as [R0 ^] would otherwise exceed the maximum, [R0 ^] is kept at its maximum. If [R0 _] is then reduced again, [R0 ^] is also immediately reduced again. The minimum span is given in the technical data of the respective device.

5.2 Switching threshold OUT1

OUT1 changes its switching status when the configured upper and lower thresholds [d ISP, d I r P] are exceeded. The source d IS defines the signal at the output Out1.

Two sources are available:

- Two-colour mode: [d I] \rightarrow [d IS] = SP E c. (PK 62, PK 72/PK 73/PK 74)
- One-colour mode: [d I] \rightarrow [d IS] = 9U0t. (PK 62)

First set the upper temperature value of the switching point [d ISP]. The temperature can be defined in $^{\circ}\text{C}$ or $^{\circ}\text{F}$ according to the unit setting. Then set the lower threshold [d I r P]. When you adjust the upper threshold [d ISP]

the lower threshold $[d_{LRP}]$ will change accordingly. The span remains the same. If $[d_{LSP}]$ is lowered to a value where the span cannot be maintained (as $[d_{LRP}]$ would then fall below its minimum value), the $[d_{LRP}]$ is kept with its minimum value.

If $[d_{LSP}]$ subsequently increases again, $[d_{LRP}]$ also immediately increases. The minimum distance between $[d_{LSP}]$ and $[d_{LRP}]$ is 2 K.

5.2.1 Output signal

The following switching functions can be selected:

- Normally open contact: $[d_I] \rightarrow [d_{IFN}] = NO$ (normally open)
- Normally closed contact: $[d_I] \rightarrow [d_{IFN}] = NC$ (normally closed)

5.2.2 Upper threshold delay

Once the sensor has detected a temperature which exceeds the switching threshold $[d_{LSP}]$ the time delay $[d_{LDS}]$ starts running. When this delay period has elapsed, the output OUT1 activates switching. This status is maintained until the lower threshold $[d_{LRP}]$ is violated. If this occurs before the time delay has elapsed, the delay will reset. This function can be used, for example, to suppress spurious impulse signals at the output.

- Upper threshold delay: $[d_I] \rightarrow [d_{LDS}] = 0 \dots 10 \text{ sec.}$

5.2.3 Lower threshold delay

- The output impulse can be lengthened to make sure that the output impulse is correctly identified, e.g. by a downstream control system.
- Lower threshold delay: $[d_I] \rightarrow [d_{LDR}] = 0 \dots 10 \text{ sec.}$

5.2.4 Switching functions

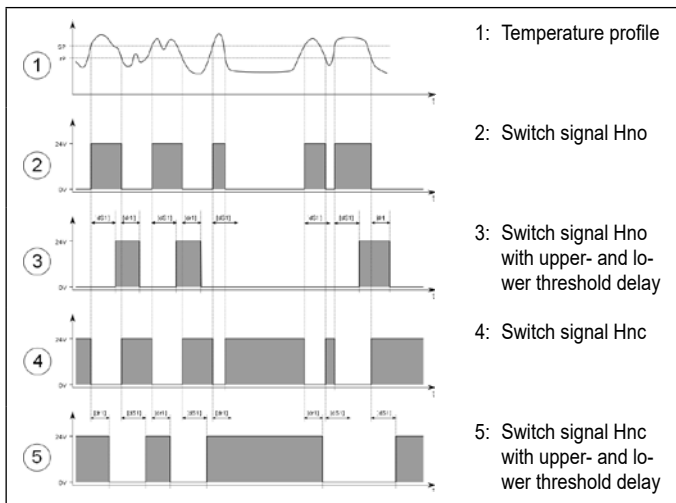

5.2.5 Internal signal processing

Temperature

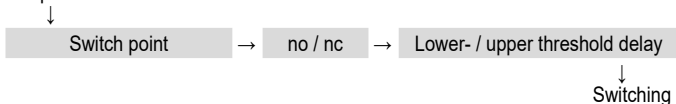

5.3 Switching threshold OUT2 (PK 62)

OUT2 changes its switching mode in relation to the set function.

The following functions are available as a source for OUT2:

- Dirt alert
- Sync-pulse
- Inner device temperature

5.3.1 Dirt alert (PK 62)

A dirt alert function is available to ensure a safe measurement for the PK 62 pyrometer. The dirt alert function warns the user if, for example, the lens, an attached protective glass or the sighting cone of the pyrometer gets dirty during a measurement.

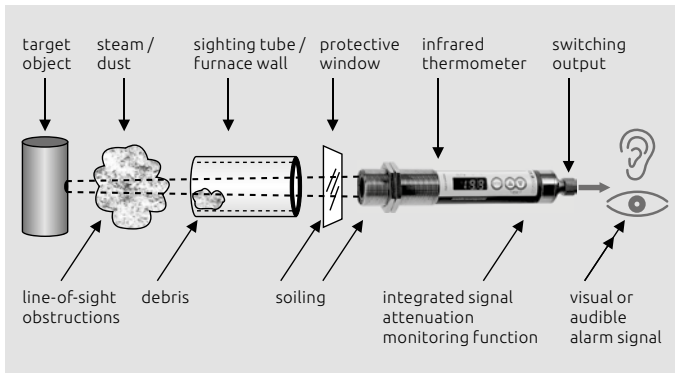

The dirt alert is activated with parameter [d2] → [d2.5] → d, r t. The dirt alert is a warning function. This warning will become active when the set threshold [Q] → [Q.d.r.t]. During measurements of discontinuous processes this warning is only active when the target object is detected by the pyrometer and the threshold is violated.

! The parameter [d, r t] dirt alert should be set to a signal intensity of 0.5 x. The pyrometer will stop to calculate the ratio temperature when the disconnection threshold [Q] → [Q.L, N].

! The current signal strength can be displayed with parameter Q signal strength [Q] → [Q.S, E].

5.3.2 Sync-pulse (PK 62)

With active memory function $\text{d} \text{E} \text{d}$, a sync pulse is generated when the threshold is violated. Further details are given in chapter 13.4).

5.3.3 Inner device temperature (PK 62)

If the internal temperature of 75 °C is exceeded, the switching mode of switching output OUT2 changes according to its configuration. When the internal temperature is < 70 °C, the switching output OUT 2 switches back to its original state.

5.3.4 Output signal (PK 62)

The following switching functions can be selected for dirt alert, signal strength and inner device temperature:

- Normally open contact $[\text{d} \text{E}] \rightarrow [\text{d} \text{E} \text{F} \text{r}] = \text{r} \text{o}$ (normally open)
- Normally closed contact $[\text{d} \text{E}] \rightarrow [\text{d} \text{E} \text{F} \text{r}] = \text{r} \text{c}$ (normally closed)

5.3.5 Upper threshold delay (PK 62)

Once the sensor has detected a temperature which exceeds the switching threshold $[\text{d} \text{E} \text{S} \text{P}]$ the time delay $[\text{d} \text{E} \text{d} \text{S}]$ starts running. When this delay period has elapsed, the output OUT1 activates switching. This status is maintained until the lower threshold $[\text{d} \text{E} \text{r} \text{P}]$ is violated. If this occurs before the time delay has elapsed, the delay will reset. This function can be used, for example, to suppress spurious impulse signals at the output..

- Upper threshold delay: $[\text{d} \text{E}] \rightarrow [\text{d} \text{E} \text{d} \text{S}] = 0 \dots 10.0 \text{ sec.}$

5.3.6 Lower threshold delay

The output impulse can be lengthened to make sure the output impulse is correctly identified, e.g. by a downstream control system.

Lower threshold delay: $[\text{d} \text{E}] \rightarrow [\text{d} \text{E} \text{d} \text{r}] = 0 \dots 10.0 \text{ sec.}$

5.4 Setting the emissivity ratio (two-colour mode, PK 62)

The difference between measured temperature and true temperature can be compensated by changing the emissivity ratio. Make this adjustment for selective interferences or when the emissivity for wavelength 1 and wavelength 2 will be different because of the material that is being measured.

- Emissivity ratio [E] → [E P] = 80 - 120 %



The pyrometer has a quick adjustment feature to set the emissivity ratio. In process value mode, the value can be set directly with the keys ▲ or ▼. It is not necessary to access the menu. When simultaneously pressing the MODE key, the display shows the current measuring temperature while the emissivity coefficient continues to be adjusted in the background. This is an easy way to determine the emissivity when the object temperature is known. The changed values are directly adopted.

EN

5.5 Emissivity of materials (one-colour mode)

The pyrometer reacts to the thermal energy (infrared radiation) emitted by an object. The ability to radiate heat depends on the type of material and its surface properties. A description of the calculation of emissivity is in Chapter 16/ Page 41. The ability of a body to emit infrared radiation is expressed by a material constant called emissivity coefficient or just emissivity. This coefficient lies between 0 and 100 %. A body with ideal radiation (black body) has a coefficient of 100 %. At the same temperature, bodies with real radiation emit a lower radiation. Therefore, the emissivity coefficient is < 100%. For this reason, adjust the emissivity coefficient of the target object on the pyrometer to be able to determine the exact temperature. With the configured lower emissivity coefficient, the pyrometer automatically compensates for the lower radiation.

- Emissivity: [S] → [S P S] = 10...110%



For the emissivity, the pyrometer has a quick adjustment function. In the process value display the value can directly be entered by using the ▲ or ▼ button without changing to the menu. When simultaneously pressing the MODE key, the display shows the current measuring temperature while the emissivity coefficient continues to be adjusted in the background. This is an easy way to determine the emissivity when the object temperature is known. The modified values are directly adopted.



Change the emissivity only when the measuring mode "one-colour" is active.

Measuring mode one-colour mode [R o] → [R o S] = [S P E c.]

5.6 Transmission factor (one-colour mode)

Besides the emissivity correction, a pyrometer must be adjusted for the transmission properties of any supplementary lens and/or protective window screwed onto the pyrometer. Set the pyrometer for the specific transmission factor (a percentage value) which is indicated either in the product's data sheet or on the lens itself. If you are not using any auxiliary lens or protective window, set the parameter to 100.0.

- Transmission factor [S] → [Set RU] = 1000

5.7 IO-Link

This device has an IO-Link communication interface, which requires an IO-Link-capable module (IO-Link master) for operation. The IO-Link interface allows direct access to process and diagnostic data and offers the possibility to parameterize the device during operation.

The IODDs required for configuring the IO-Link device as well as detailed information on process data set-up, diagnostic functions and parameter addresses are available in the download area at www.keller-msr.de/pyrometer.



A 3-wire cable port Class A (Type A) must be used for IO-Link operation.

6 Electrical connection

6.1 CellaCombustion PK 62

⚠ ATTENTION

The pyrometer may only be installed by a skilled, qualified electrician. Do not connect the instrument while the voltage supply source is turned on. Please observe international safety regulations at all times.

EN

- ▶ Switch to neutral and verify absence of voltage
- ▶ Connect the instrument according to the following schematic:

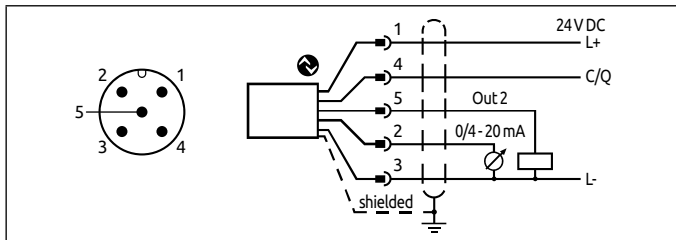

| | | |
|-------|------------|--|
| Pin 1 | BN (brown) | L+ (Power supply 24V DC) |
| Pin 4 | BK (black) | Open Collector switching output; $I_{\max} = 150 \text{ mA}$ OUT1 or IO-Link |
| Pin 5 | GY (grey) | Open Collector switching output; $I_{\max} = 150 \text{ mA}$ OUT2 |
| Pin 2 | WH (white) | Analogue output; 0/4 ... 20mA |
| Pin 3 | BU (blue) | L- (Shield) |



The pyrometer must be protected against high voltage and strong electromagnetic fields. Use a shielded cable, connecting it via connector casing to the device housing.



Use a flyback diode when switching inductive loads.

6.2 CellaCombustion PK 72 / PK 73 / PK 74

⚠ ATTENTION

The pyrometer may only be installed by a skilled, qualified electrician. Do not connect the instrument while the voltage supply source is turned on. Please observe international safety regulations at all times.

- ▶ Switch to neutral and verify absence of voltage
- ▶ Connect the instrument according to the following schematic:

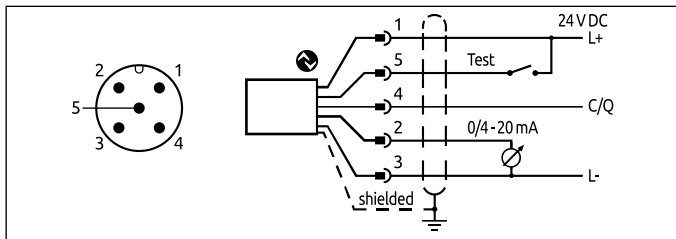

| | | |
|-------|------------|--|
| Pin 1 | BN (brown) | L+ (Power supply 24V) |
| Pin 5 | GY (grey) | Test Input |
| Pin 4 | BK (black) | Open Collector switching output; $I_{\max} = 150 \text{ mA}$ or IO-Link |
| Pin 2 | WH (white) | Analogue output; 0/4 ... 20mA |
| Pin 3 | BU (blue) | L- (Shield) |



The pyrometer must be protected against high voltage and strong electromagnetic fields. Use a shielded cable, connecting it via connector casing to the device housing.



Use a flyback diode when switching inductive loads.



If the diagnostics function is not used, connect the diagnostics input (Pin 5) to minus. As an alternative, use a 4-pole cable box where Pin 5 is not assigned.

7 Shielding and Grounding

7.1 Equipotential bonding

The pyrometer housing is connected to the shielding via the cable connector!

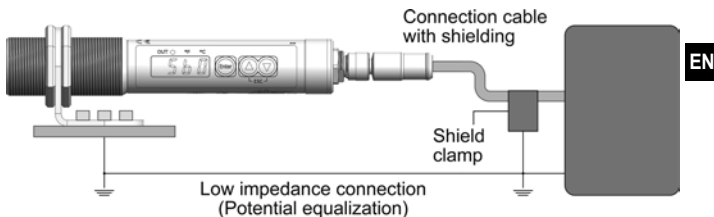

Differences in ground potentials might cause an equalising current to flow between devices through a cable shielded at both ends. In this case, be sure to install an additional equipotential bonding line.

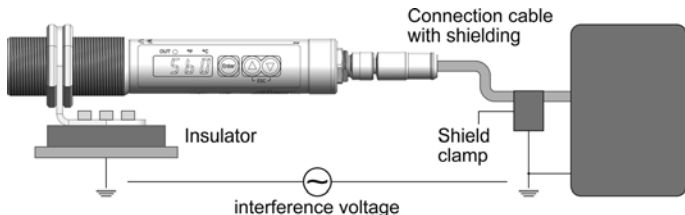

To avoid an equalising current, the pyrometer can be mounted electrically insulated. The shielding must be connected to the plant's earthing system.



If the pyrometer is installed without an insulator and without potential equalisation, the interference voltage may not exceed 32V.

8 Operating controls and display

The pyrometer features a 4-digit display, 3 control keys and 3 LEDs. The instrument's display panel shows the measured temperature.

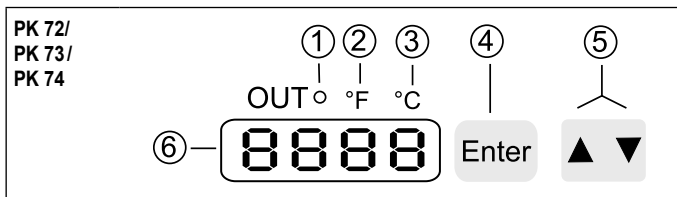
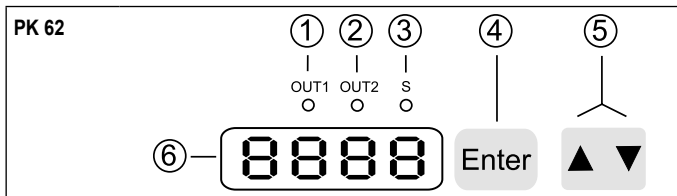

| | PK 62 | PK 72 / PK 73 / PK 74 |
|---|---|--|
| 1 bis 3: Indicator-LEDs | LED 1: indicates switching output OUT1 LED 2: indicates switching output OUT2 LED 3: signal strength | LED 1: indicates switching output of the respective output LED 2: temperature in °F LED 3: temperature in °C |
| 4: Control key Enter | Select parameter and confirm setting | |
| 5: Control key up and down | Adjust configuration parameters | |
| 6: Alphanumeric display, 4-digit | Indicates temperature value Indicates parameters and configuration Indicates overload at switching output | |

9 Menu PK 62

9.1 Process value display

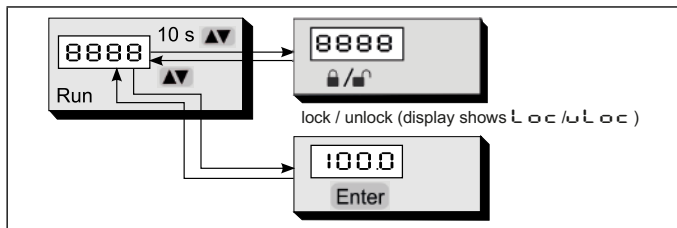

9.2 Analogue output

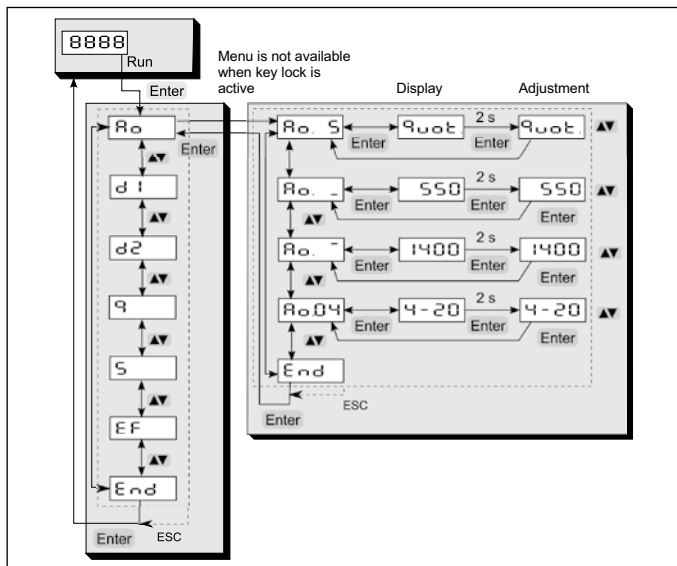

9.3 Digital threshold OUT1

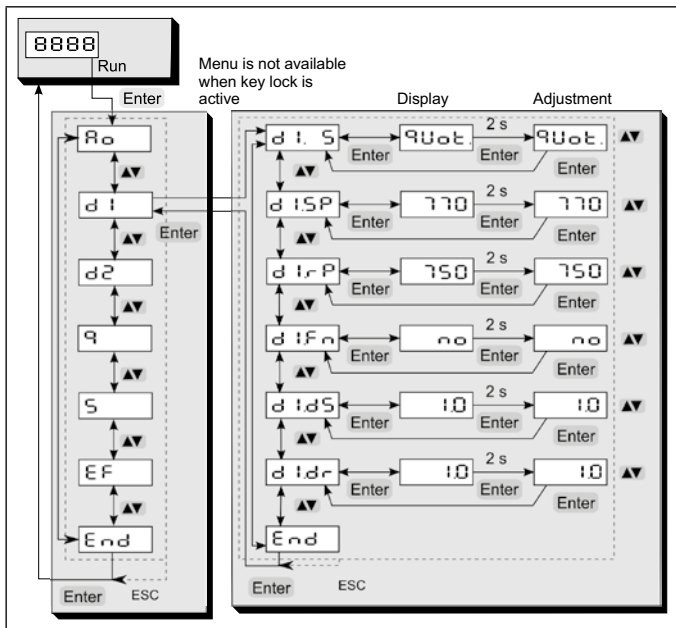

9.4 Digital threshold OUT2

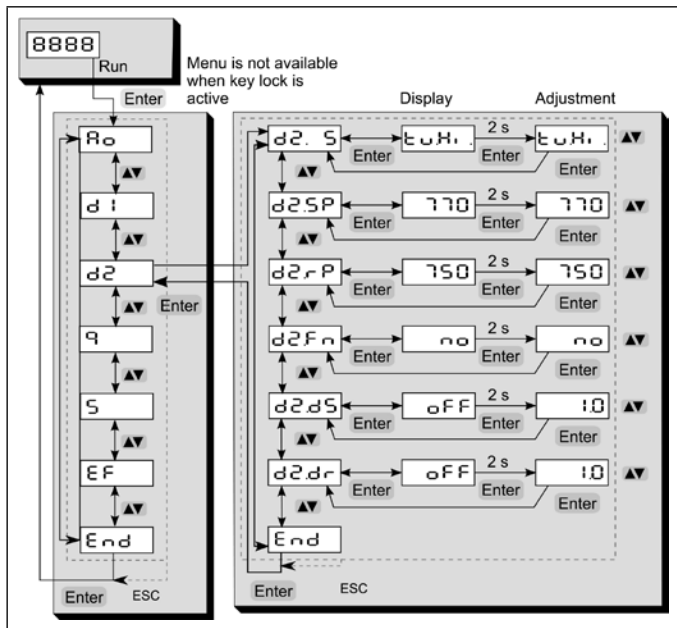

9.5 Two-colour mode

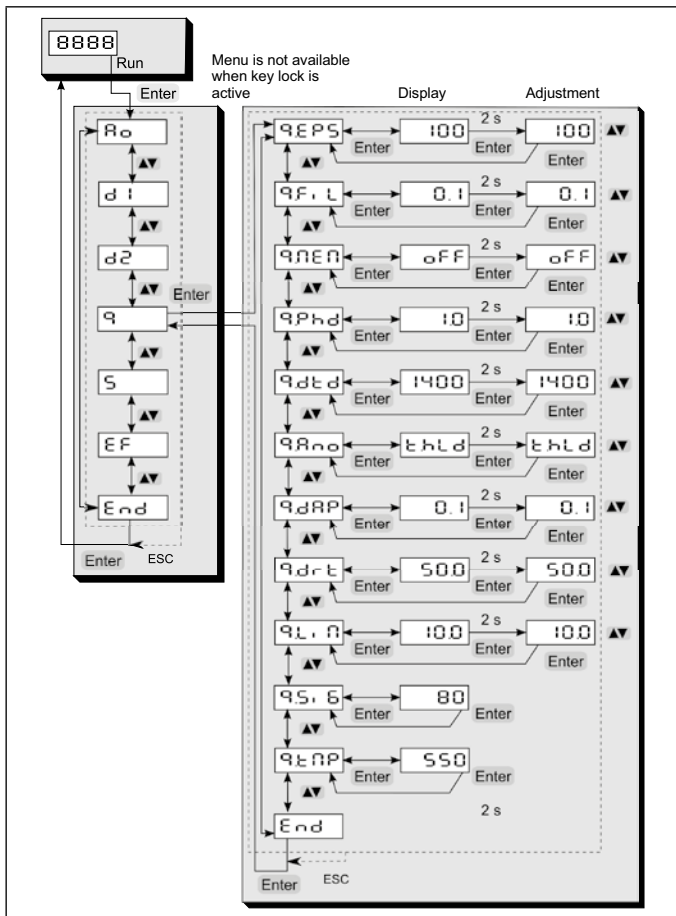

9.6 One-colour mode

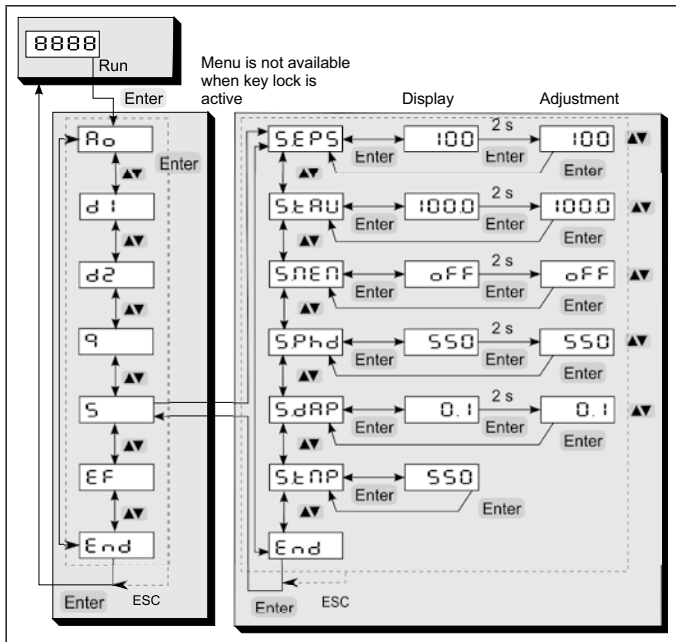

9.7 Advanced Features

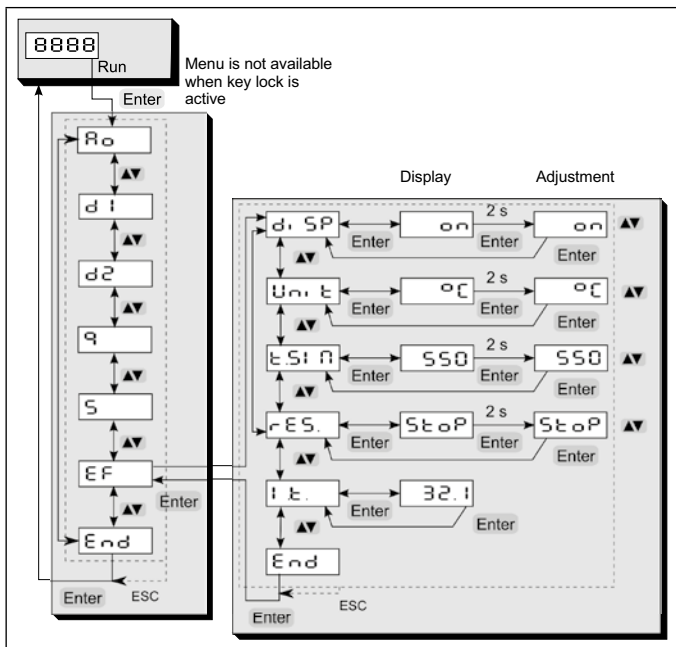

10 Menu explanation PK 62

10.1 Analogue output

| Parameter | Function | Explanation |
|-------------------|----------------------------------|--|
| R ₀ S | Select source | 9U0E . two-colour mode SPEC . one-colour mode (the selected temp. reading source will be shown on the display) |
| R ₀ _ | Define lower limit of temp. span | Analogue start value for scaling |
| R ₀ ^ | Define upper limit of temp. span | Analogue end value for scaling |
| R ₀ 04 | Analogue output 0/4 -20 mA | 0 -20 mA scaling Analogue output 4- 20 mA scaling Analogue output |
| E n d | End | |

EN

10.2 Switching threshold OUT1

| Parameter | Function | Explanation |
|-----------|-------------------------|--|
| d I S | OUT1 source | 9U0E . two-colour mode SPEC . one-colour mode |
| d I S P | OUT1 Upper threshold | Upper threshold which activates OUT1 |
| d I r P | OUT1 Lower threshold | Lower threshold which activates OUT1 |
| d I F n | Output function | n c normally closed n o normally open |
| d I d S | Upper threshold delay | Value in sec (≤ 10 sec in steps of 0.1) |
| d I d r | Lower threshold delay | Value in sec (≤ 10 sec in steps of 0.1) |
| E n d | End | |

10.3 Switching threshold OUT2

| Parameter | Function | Explanation |
|-----------|------------------------------|---|
| d2S | OUT2 source | 900E . two-colour mode SPEC . one-colour mode E0h . inner device temperature dirt . dirt alert Sync . sync-pulse* |
| d2SP | OUT2 950 Upper threshold | Upper threshold which activates OUT2 |
| d2rP | OUT2 930 Lower threshold | Lower threshold which activates OUT2 |
| dIFn | Output function | nc normally closed no normally open |
| d1dS | Upper threshold delay OFF | Value in sec (≤ 10 sec in steps of 0.1) |
| d1dr | Lower threshold delay OFF | Value in sec (≤ 10 sec in steps of 0.1) |
| End | End | |

* Function at OUT2 only available with DTD function

10.4 Messwerterfassung Quotient

| Parameter | Function | Explanation |
|-----------|--|--|
| 9EP5 | Ratio correction | Ratio correction 80- 120 % |
| 9F.L | Smoothing filter for min/ max memory [#] | OFF no smoothing time t_{98} 0-10 sec in 0.1 sec steps |
| 9NE0 | Min/max memory | OFF off PHLD Peak hold function dtd DTD function |
| 9Phd | Hold time peak hold function* | time t_{98} in seconds (in steps of 0.1 sec) |
| 9dtd | DTD limit** | See chapter 13.4 |
| 9Rno | Display mode during sampling time | $\bar{t} = 0$ show lower limit of temp. range during running measurement $\bar{t} hld$. Hold previous temp. reading during running measurement |
| 9dAP | Damping after min/max memory* | OFF off time t_{98} 0-999,9 sec in 0.1 sec steps |
| 9dr t | Pollution warning level | Value in % 0.1 - 100 % |
| 9L. 0 | switch-off threshold | Value in % 0.1 - 100 % |
| 9FLn | Soot factor | Value off, 0.5 - 2.5 |
| 9FLd | Q- Flame density | Calculated flame density, 0 - 10 |
| 9S. 6 | Q- signal intensity | Calculated signal intensity in % |
| 9tNP | Q- temperature reading | Two colour/ratio temperature reading |
| E nd | End | |

[#] The filtering affects the temperature reading and the signal intensity of the two-colour mode.

* Only available with peak hold function

** Only available with DTD function

10.5 Measurement acquisition (one-colour mode)

| Parameter | Function | Explanation |
|-----------|--------------------------------|---|
| SEPS | Emissivity factor | Emissivity 10 - 110 % |
| SEAU | Transmission factor | 10 - 100 % (see chapter 5.17) |
| SEEN | Max/min memory | OFF off PHLD Peak hold function |
| SPhd | Hold time peak hold function * | Time sec (in 0.1 sec steps) |
| SDAP | Damping after min/max memory * | OFF off Time in sec (in 0.1 sec steps) |
| SENP | One-colour temperature reading | One-colour temperature reading |
| End | End | |

* Menu item only if Peakhold is activated

10.6 Advanced Features

| Parameter | Function | Explanation |
|-----------|------------------------|---|
| d. SP | Process value display | On current temperature value OFF run is shown in the display |
| Unit | Temperature unit | °C °F |
| ESN | Temperature simulation | A temperature can be simulated |
| RES | Factory settings | Reset to factory settings |
| i. t. | Internal temperature | |
| End | End | |

11 Menu PK 72 / PK 73 / PK 74

11.1 Process value display

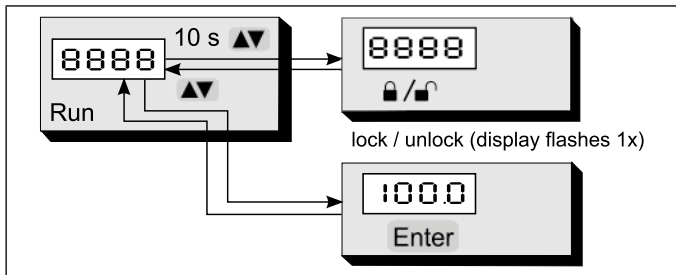

EN

11.2 Digital output OUT1

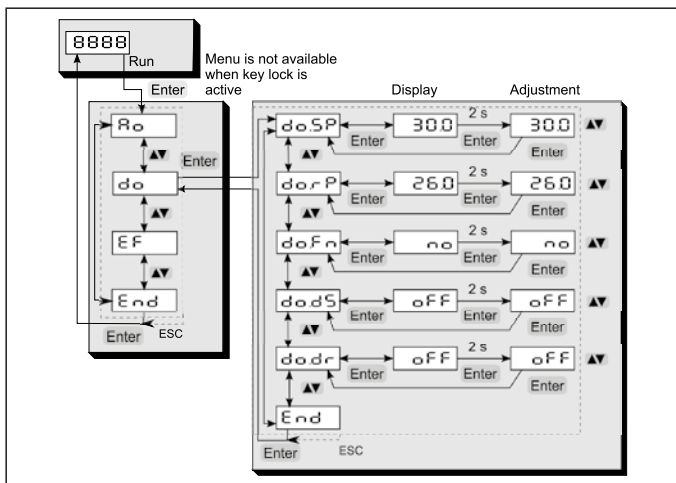

11.3 Analogue output OUT2

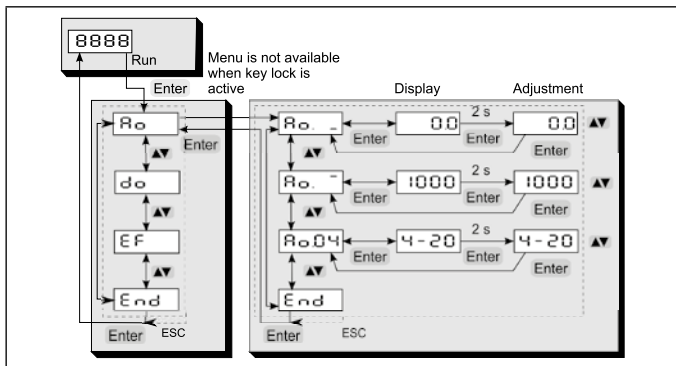

11.4 Advanced Features

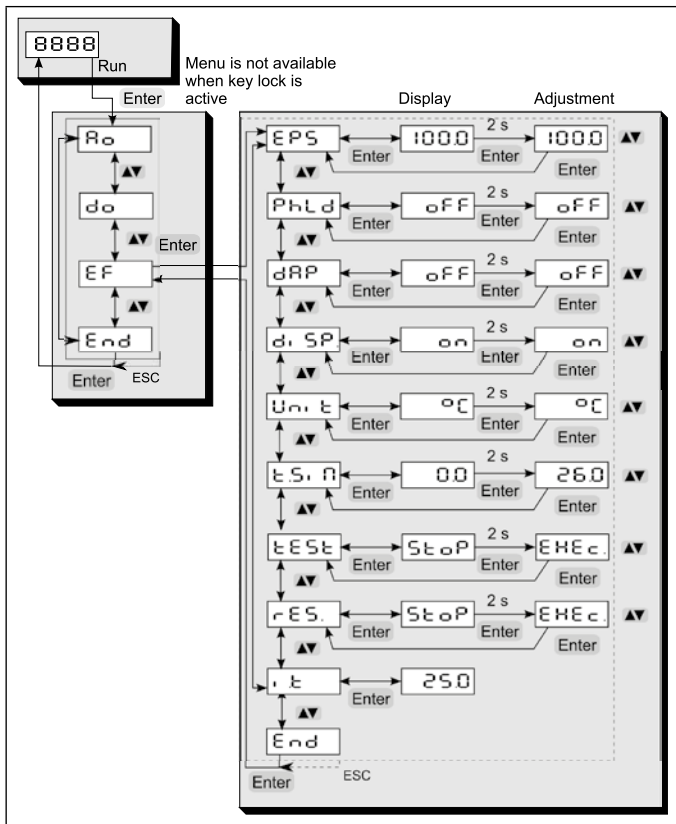

12 Menu explanation PK 72 / PK 73 / PK 74

12.1 Digital output OUT1

| Parameter | Function | Comments |
|-------------------------------|-----------------------|--|
| d _o S _P | OUT1 Upper threshold | Upper threshold which activates OUT1 |
| d _o r _P | OUT1 Lower threshold | Lower threshold which activates OUT1 |
| d _o F _n | Output function | n _o normally opened n _c normally closed |
| d _o d _S | Upper threshold delay | Value in sec (≤ 10 sec in steps of 0.1 sec) |
| d _o d _r | Lower threshold delay | Value in sec (≤ 10 sec in steps of 0,1 sec) |
| E _n d | End | |

12.2 Analogue output OUT2

| Parameter | Function | Comments |
|-------------------|---------------------------------|--|
| R _a - | OUT2 Beginning of range | Analogue start value for the range |
| R _a - | OUT 2 End of range | Analogue end value for the range |
| R _a 04 | Analogue output 0/ 4 - 20 mA | 0 - 20 mA Scaling Analogue output 4 - 20 mA Scaling Analogue output |
| E _n d | End | |

12.3 Advanced Features

| Parameter | Function | Comments |
|-----------|------------------------|---|
| EPS | Emissivity | Correction of the radiation properties of the measured object (10...110%) |
| PHLD | Peak hold function | Configuration of the peak hold function (OFF/ 0,1 - 999,9 s) |
| DRP | Damping | Damping for the temperature display, switching output and analogue output (OFF/ 0,1 - 999,9 s) |
| di SP. | Process value display | Specifies what is displayed in the process value display ON → current temperature value OFF → run is shown in the display |
| Unit | Temperature unit | Temperature displayed in °F or °C |
| TSN | Temperature simulation | A temperature can be simulated (affects on OUT1 and OUT2) |
| TEST | Test function | Activates diagnostics for self-test (10 sec. timeout) |
| RES | Factory settings | Reset to factory settings |
| IT | Internal temperature | Displays the current internal temperature |
| End | End | |

13 Setup

13.1 PK 62 (Flame temperature measurement)

By default, the PK 62 is configured for the two-colour measurement.

The pyrometer must be aligned so that the maximum signal strength [Q.Si6] is shown in the display.

To align the pyrometer it is recommended to use the internally calculated signal strength.

For this purpose, the pyrometer must be parameterised in such a way that the signal strength is shown in the display.

► Two-colour: [9] → [9.5, 6]

> the current signal strength is shown in the display.

The pyrometer must be aligned so that the maximum signal strength is shown in the display.

The PK 62 monitors the signal strength. If the signal strength drops too much due to dust, steam, smoke or contamination of the protective window, this is indicated by LED 3.

| | |
|-----------------|---|
| LED 3 lights up | Measurement OK |
| LED 3 flashes | Signal strength below the set threshold – measurement is critical |
| LED 3 off | The signal strength is too low, a measurement is not possible |

For the flame measurement, the soot factor of the flame must be set. This factor is determined by the flame type.

As a first approximation, the parameter should be set to 1.2. If necessary, the device can be set to the real flame type. For this purpose, a reference measurement is carried out, e.g. with a thermocouple, and the PK 62 is set to the reference temperature by way of the soot factor.

► Two-colour: [9] → [9F Ln] → [1.2]

When using protective windows, the transmission of the window must be adjusted for the spectral channel. The value to be set can be found in the specification of the window.

- ▶ Lambda 1: [S] → [SETAU] = 760
(Setting when using the sapphire window from KELLER)

It is strongly recommended to use only approved protective windows specified by the manufacturer, which remain neutral regarding the wavelengths. If you use commercial glass there is a risk of a faulty measurement due to selective influences.



The protective window offered by the manufacturer is made of sapphire. The transmission for the lambda value 1 is 76%. The emissivity ratio does not need to be changed.

13.2 PK 72 / PK 73 / PK 74 (CO₂ measurement)

The pyrometer must be aligned so that the maximum temperature is shown on the display. The pyrometer uses the intensity of infrared radiation for the non-contact temperature measurement. In order to obtain exact measured values, the emissivity must be set.

The emissivity is set as follows.

- ▶ Press [▲ or ▼]
- > the value of the selected emissivity is displayed, for example [1000]
- ▶ Press [▲ or ▼] until the desired emissivity is shown

Press [Enter] or wait for 3 seconds

>> The current temperature value is displayed. The pyrometer now works with this configured emissivity until it is changed again.

Emissivity determination by contact measurement

The temperature is measured with a thermocouple and simultaneously determined with the pyrometer. The emissivity is set so that both instruments display the same measured value.

14 Operating parameters

When you reset/adjust the operating parameters the instrument remains in run mode. It continues to operate, using the current parameter settings, until you have finished configuring by pressing [Enter].

14.1 Setting parameters – general information

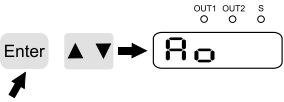
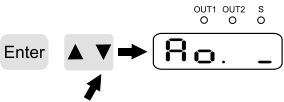
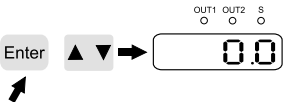
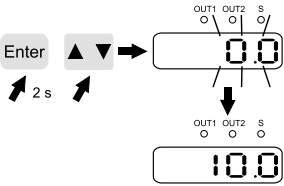
| | |
|---|--|
| <p>1 Select parameter</p> <p>▶ Press [Enter] to access the main menu.</p> |  |
| <p>2 Select output function</p> <p>Press key [▼] until the required output function or the Advanced Features is displayed.</p> |  |
| <p>3 Show parameter value</p> <p>▶ Press [Enter]</p> <p>> Current parameter value is displayed. *</p> |  |
| <p>* The pyrometer will display the parameter value for 30 sec. After that the display will once again indicate the measurement as a percentage.</p> | |
| <p>4 Change parameter value</p> <p>▶ Press ENTER for 2 seconds,</p> <p>> display flashes continuously</p> <p>▶ Press [▲] or [▼] to change the parameter</p> |  |

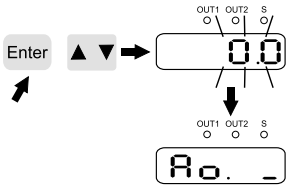
| | |
|---|---|
| <p>5 Confirm parameter value</p> <ul style="list-style-type: none"> ▶ Press [Enter] > The display indicates the parameter. The new value has been saved and will take effect. |  |
| <p>Adjust additional parameters</p> <ul style="list-style-type: none"> ▶ Start again with step 2. | |
| <p>Exit operating parameters layer</p> <ul style="list-style-type: none"> ▶ Wait 30 seconds <p>or</p> <ul style="list-style-type: none"> ▶ Press [▲] or [▼] to change to the parameter E_{nd}. Then press [Enter] to change to the functional menu. | |



The instrument features a keylock. Activate/deactivate the keylock as follows:

- ▶ Press key [▲▼] simultaneously and hold them down for 10 sec.
- > The display shows Loc or uLoc for 1 second to signalize the change.



If you press both keys [▲▼] only briefly, you will exit the layer (ESC function).

14.2 Damping function

When the target object's temperature is erratic, the damping function smoothens these temperature fluctuations in order to stabilize the measuring signal. The greater the time constant [dRP], the lower the effect of these fluctuations on the yielded temperature reading.

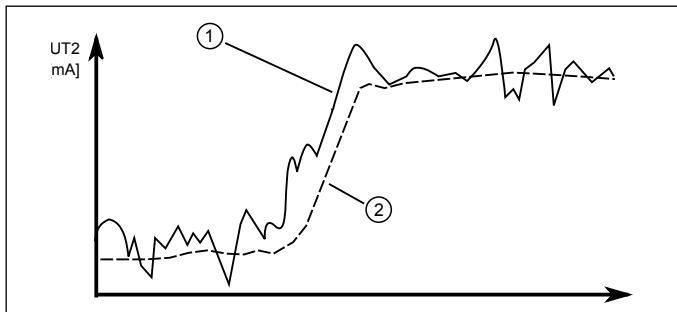

- 1: Output signal without smoothing function
- 2: Output signal with smoothing function

14.3 Peak hold function

It might often be desirable to determine the peak temperature during a defined time period, for example when the objects to be measured move past the pyrometer, resulting in temperature readings which would appear to be cyclical. In this mode, the displayed temperature reading will not drop between targeted objects. The peak temperature reading will be held for a preset time period.

The hold time [PHLD] can be set from 0.1 to 999.9 sec. The maximum temperature sampled during the defined hold time will be saved. It makes sense to choose a hold time which is approximately 1.5 times as long as the cycle of the moving targets. This avoids temperature drops. Rising temperatures are still recognised at once.

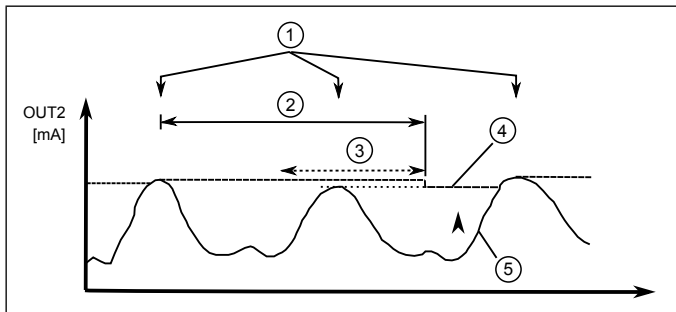

- 1: Measuring object in front of pyrometer
- 2: Hold time
- 3: Measurement time of the second internal peak value memory
- 4: Measuring readings with peak hold function
- 5: Measuring readings without peak hold function

14.4 DTD function (Discontinuous Temperature Detection at PK 62)

This function serves to automatically detect the temperature during manufacturing processes with discontinuous or intermittent material flow. For example, thus can determine the temperature of bolts with variable lengths, that move acyclic along the pyrometer. A temperature threshold has to be defined for this purpose. The measurement starts when the object temperature is higher than the set threshold.

• [9] → [97E 7] = [d t d]

The measurement stops when the threshold is violated and the maximum value is available at the analogue output.



The reset point is 5 K below the parameterised threshold.

In parallel, a sync pulse is given to OUT2. OUT2 is switching when the threshold is exceeded, depending on the parameters set. If the value falls below the threshold, OUT2 returns to its previous state.

• [d 2] → [d 25] = [5 4 n c]

It can further be set which temperature is displayed or available at the output during the measurement.

- $[d2] \rightarrow [9800] = [t h l d]$ During the measurement the previous reading is available at the temperature output.
- $[d2] \rightarrow [9800] = [t 0]$ During the measurement the temperature is set to the lower limit of the temperature range.

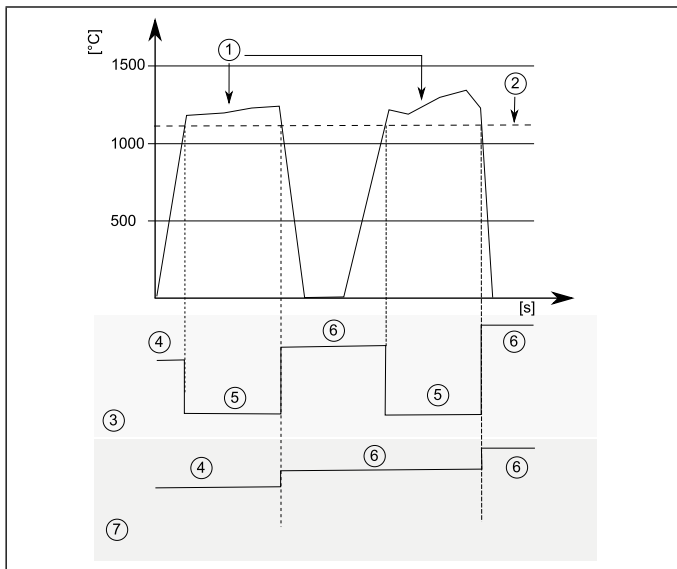

- 1: Measuring object in front of pyrometer
- 2: Limit $[d t d]$
- 3: Temperature output $[9800] = [t 0]$
- 4: Previous reading
- 5: Lower limit of temperature range
- 6: New reading
- 7: Temperature output $[9800] = [t h l d]$

14.5 Reset all parameters to factory settings

▶ [$r \ E \ S$] select in menu advanced functions

▶ Press [ENTER]

> The display shows [STOP]

▶ Hold [ENTER] for 2 seconds

> Display flashes for 2 seconds

▶ Press [\blacktriangle]

> The display shows [$E \ H \ E \ c \ .$]

▶ Press [ENTER]

> The display shows the current temperature



After a reset to factory settings configure the emissivity coefficient [$E \ P \ S$] again (\rightarrow 10 Setup) to obtain exact measuring results.

15 Operation

After connecting the supply voltage the pyrometer will be automatically initialized and will perform a self-diagnosis. After approx. 0.5 sec the sensor is ready to operate and the instrument runs the signal processing.

The parameters for the PK 62 are described in chapter 10 from page 27 and for the PK 72 / PK 73 / PK 74 in chapter 12 from page 34.

15.1 Ambient temperature

The maximum permissible ambient operating temperature for the pyrometer is 65 °C. If the instrument is used in ambient temperatures above 65 °C, it must be either cooled or shielded from excess radiant heat by means of a deflector plate.

15.2 Error indications

| | |
|--|--|
| Overload output | The corresponding LED OUT 1 will flash at 4 Hz. The display shows "5 C !" at 2 Hz. |
| Overtemperature | Display $\square \text{E}$ alternately shows overtemperature and measurement reading at = 0.5 Hz. The corresponding LED flashes at 4 Hz when the output is switched off. |
| Incorrect connection of supply voltage | LED OUT 1 flashes at 2 Hz. |
| Supply voltage \leq approx. 16 V | LED, display, switching output and analogue output are deactivated. (When voltage \geq 16 V the device switches on and the switching outputs are activated). |
| Temperature below lower threshold | The display shows UL . |
| Temperature above upper threshold | The display shows OL . |

16 Theory of Non-Contact Temperature Measurements

All materials radiate thermal energy in all states of aggregation above absolute zero. This radiation is mainly caused by atomic or molecular oscillations.

This temperature radiation is only a limited sector within the total electromagnetic radiation spectrum. It extends from the visible range starting at wavelengths of approx. 0.5 μm to the infrared range with wavelengths of more than 40 μm . Radiation pyrometers detect infrared radiation for non-contact temperature measurement.

16.1 Advantages of Non-Contact Temperature Measurement

- Non-contact temperature detection means cost-effective temperature measurement because this technique only requires a single investment in an instrument without any follow-up costs for consumables such as thermocouples.
- This method enables temperature detection of moving objects - quick temperature measurements within milliseconds - for example at automatic welding processes.

- Small objects with medium and high temperatures can also be easily and accurately measured.
- When measuring materials with low specific heat, a non-contact method does not induce heat loss which would distort the temperature reading (as is the case with contact temperature probes). Non-contact temperature detection is ideal with corrosive molten materials for which the use of thermocouples is hardly feasible.
- Last but not least it is also possible to measure the temperature of voltage-carrying objects.

16.2 Measurements at Black Bodies (Cavity Radiators)

A black body or a black radiator is used to calibrate radiation pyrometers. This black body is designed in a way that its radiation does not

depend on material characteristics, but only on its temperature. A black body emits at any wavelength the maximum energy possible for the specific temperature. Real bodies do not have this ability. In other words, a black body completely absorbs the radiation without reflection or transmission losses. The spectral emissivity coefficient $\epsilon(\lambda)$ of a black body is equal to 1 or 100 %. The emissivity coefficient indicates the ratio of radiation of a real body (target) to the radiation of an ideal black body.

$$\epsilon(\lambda) = \frac{M}{M_S}$$

$\epsilon(\lambda)$: Emissivity coefficient of the object's surface (targeted spot) at wavelength λ

M: radiant energy actually emitted by a real object

M_S : radiant energy emitted by a black body (perfect radiator)

Most burning, annealing and hardening furnaces emit a radiation of nearly 1, which corresponds to the conditions of a black body if the aperture through which the measurement is made is relatively small.

16.3 Measurements of Real Radiators

Real radiation sources are characterized by the relation of the emitted radiation to the radiation of a black body with the same temperature. Measurements outside a furnace - which applies to all other self-contained targets - always show a reading which is too low. Considerable errors can occur at targets with reflecting, polished or bright surfaces, e.g. molten steel and metal without oxide layer and ceramic materials. Exact results can only be obtained when the emissivity coefficient is correctly adjusted on the pyrometer.

The spectral emissivity coefficient of a body does not represent an exact material constant, but is also largely dependent on the surface properties (→ 16 Ways to determine emissivity).

17 Maintenance

17.1 Cleaning the pyrometer lens

A false temperature reading will be given when the lens is dirty. Therefore, check the lens periodically and clean it, if necessary.

Dust can be removed by simply blowing it away or by using a soft brush. A special lens cleaning cloth is ideal, but any soft, clean, lint-free cloth will be suitable.

If the lens is quite dirty, use a very mild liquid detergent and rinse carefully with clear water while holding the device pointed down.

Apply as little pressure as possible to avoid scratching the lens.

18 Shipping, packaging and disposal

18.1 Inspection after shipping

Unpack and inspect the entire shipment immediately upon receipt to make sure it is complete and undamaged. If the container/package shows visible signs of damage, please refuse the shipment. If this is not possible, accept the shipment on the condition that the freight carrier's delivery record is noted with the extent of the damage in order to file a claim. Should you discover a concealed loss or damage, report it to the shipper or freight carrier immediately. If the period for filing claims has expired, you will no longer be able to make any claims for compensation of damage or loss.

18.2 Packaging

The packages used are made of carefully selected, environmentally compatible materials and are thus recyclable. Please ensure that they are disposed of in an ecologically sound manner.

18.3 Disposal of the old devices



Old electrical and electronic devices frequently still contain valuable materials. These devices can be returned for disposal to the manufacturer or they must be disposed properly by the user. For the improper disposal of the device by the user, the company KELLER HCW is not responsible.

19 Accessories and mountings

| Device | Type | Ident no. |
|----------------|--------------------|-----------|
| Shielded cable | VK 02/L AF 1: 5 m | 1043813 |
| Shielded cable | VK 02/L AF 2: 10 m | 1047718 |
| Mounting | PK 15-004 | 1079848 |
| Mounting | PK 15-005 | 1080257 |

20 General technical data

| | |
|--------------------------|--|
| Load | max. 500 Ω |
| Switching output OUT1/2 | Open Collector outputs 24 V, \leq 150 mA switch point [$^{\circ}$ C]/ reset point [$^{\circ}$ C], hysteresis \geq 2 K, Switch-on-/Switch-off-delay, NC/ NO |
| IO-Link revision | V1.1, downward compatible to V1.01 |
| SIO mode | yes, supported |
| Transmission rate | COM2 (38.400 Baud) |
| Storage temperature | -20 - 80 $^{\circ}$ C |
| Permissible humidity | 95 % r.H. max. (non condensing) |
| Power requirement | 24 V DC +10 % / -20 % Ripple \leq 200 mV |
| Housing material | Stainless steel |
| Weight | approx. 0.4 kg |
| Connectivity | 5-pin connection M12 (A coded) |
| Protection | IP 65 according to DIN 40050 with screwed plug |
| Configuration parameters | Emissivity ratio 80 - 120 % Emissivity ϵ 10 - 110 % Smoothing function t_{98} - before Max/min memory 0.1 - 10 s - after Max/min memory 0.1 - 999.9 s Peak hold function 0.1 - 999.9 s DTD function |

21 Device-specific technical data and field of view diagrams

| PK 62 AF 1 | |
|---------------------------|---|
| Temperature range | 700 - 1700 °C |
| Sensor | Double Si |
| Spectral sensitivity | 0.80 / 1.05 μm |
| Focus distance | 1500 mm |
| Target spot diameter | 21 mm |
| Analogue output | 0(4) - 20 mA linear, switchable, scalable (≥ 50 K) |
| Resolution current output | 0.2 K + 0.03 % of selected range |
| Resolution temp. reading | 1 K |
| Response time t_{90} | ≤ 10 ms |
| Repeatability | 2 K |
| Measurement uncertainty | 1.0 % of temp. reading [°C] |
| Temperature coefficient | 0.05 %/K of temp. reading / K (deviation to $T_u = 23$ °C) |
| Ambient temperature | 0 - 65 °C |
| Current consumption | ≤ 50 mA at 24 V DC without load current |
| Dimensions | M30 x 210 mm (without plug) |

EN

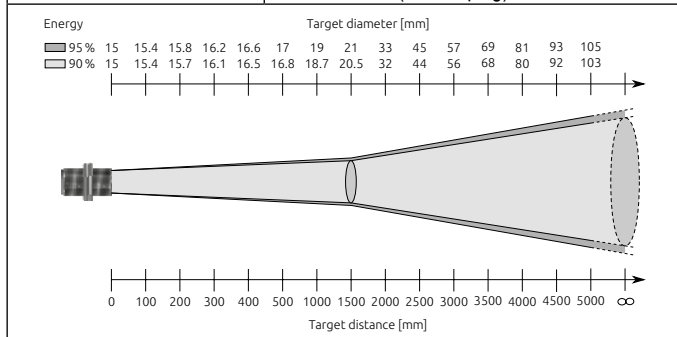

| PK 72 AF 1 / PK 74 AF 1 | |
|--------------------------------------|--|
| Temperature range | 400 - 2000 °C / 250 - 1700 °C |
| Sensor | Thermopile |
| Spectral sensitivity | CO ₂ (4.475 μm +/- 0.13 μm) |
| Focus distance | 400 mm |
| Target spot diameter | 7 mm |
| Analogue output | 0(4) - 20 mA linear, switchable, scalable (≥ 50 K) |
| Resolution current output | 0.2 K + 0.03 % of selected range |
| Resolution temp. reading | 1 K |
| Response time t ₉₀ | ≤ 60 ms |
| Repeatability [#] | 4 K |
| Measurement uncertainty [#] | 1.0 % of temp. reading [°C] |
| Temperature coefficient [#] | 0.04 %/K of temp. reading / K (deviation to Tu = 23 °C) |
| Ambient temperature | 0 - 65 °C |
| Current consumption | ≤ 50 mA bei 24 V DC without load current |
| Dimensions | M30 x 200 mm (without plug) |

| Energy | Target diameter [mm] | | | | | | | | | | | | | | | |
|--------|----------------------|------|------|------|---|----|----|----|----|------|----|-----|-----|-----|-----|--|
| 95% | 18.2 | 15.7 | 13.1 | 10.6 | 8 | 15 | 21 | 28 | 34 | 41 | 47 | 113 | 178 | 244 | 309 | |
| 90% | 18.2 | 16.8 | 12.6 | 9.8 | 7 | 13 | 20 | 26 | 32 | 38,5 | 45 | 108 | 171 | 234 | 297 | |

Target distance [mm]

[#] Data apply to a thermally stabilised state and object temperatures ≥ 400 °C.

| PK 73 AF 1 | |
|--------------------------------------|---|
| Temperature range | 500 - 2500 °C |
| Sensor | Thermopile |
| Spectral sensitivity | 4.6 - 4.9 μm |
| Focus distance | 400 mm |
| Target spot diameter | 7 mm |
| Analogue output | 0(4) - 20 mA linear, switchable, scalable (≥ 50 K) |
| Resolution current output | 0.2 K + 0.03 % of selected range |
| Resolution temp. reading | 1 K |
| Response time t_{90} | ≤ 60 ms |
| Repeatability [#] | 4 K |
| Measurement uncertainty [#] | 1.0 % of temp. reading [°C] |
| Temperature coefficient [#] | 0.04 %/K of temp. reading / K (deviation to $T_u = 23$ °C) |
| Ambient temperature | 0 - 65 °C |
| Current consumption | ≤ 50 mA bei 24 V DC without load current |
| Dimensions | M30 x 200 mm (without plug) |

| Energy | Target diameter [mm] | | | | | | | | | | | | | | | |
|--------|----------------------|------|------|------|----|----|----|----|----|----|----|-----|-----|-----|-----|--|
| 95% | 18.2 | 16.7 | 15.1 | 13.6 | 12 | 20 | 27 | 35 | 42 | 50 | 57 | 133 | 208 | 284 | 359 | |
| 90% | 18.2 | 15.4 | 12.6 | 9.8 | 7 | 13 | 20 | 26 | 32 | 39 | 45 | 108 | 171 | 234 | 297 | |

Target distance [mm]

[#] Data apply to a thermally stabilised state.

22 Factory settings

| | Parameter | Factory settings PK 62 AF 1 | User settings |
|----|-----------|--------------------------------|---------------|
| Ro | Ro S | quot. | |
| | Ro - | 700 °C | |
| | Ro ° | 1700 °C | |
| | Ro04 | 4-20mA | |
| d1 | d1 S | quot. | |
| | d1SP | 950 °C | |
| | d1rP | 930 °C | |
| | d1Fn | no | |
| | d1dS | oFF | |
| | d1dr | oFF | |
| d2 | d2 S | tu.Hi. | |
| | d2SP | 950 °C | |
| | d2rP | 930 °C | |
| | d2Fn | no | |
| | d2dS | oFF | |
| | d2dr | oFF | |
| q | qEPS | 100 | |
| | qFL | oFF | |
| | q000 | oFF | |
| | qPhd | 0.1 | |
| | qdt d | 550 | |
| | qRno | t.hld. | |
| | qdRP | oFF | |
| | qdr t | 10.0 | |
| | qL, n | 2.0 | |
| | qFL n | oFF | |

| | Parameter | Factory settings PK 62 AF 1 | User settings |
|----|-----------|--------------------------------|---------------|
| S | SEPS | 100 | |
| | SEAU | 100.0 | |
| | SEEN | oFF | |
| | SPhd | 0.1 | |
| | SDAP | oFF | |
| EF | d. SP | on | |
| | Unit | °C | |
| | t.S. n | 700 | |
| | rES. | Stop | |

EN

More information at www.keller.de/its

| | Parameter | Factory settings | | | User settings |
|----|-----------|------------------|------------|------------|---------------|
| | | PK 72 AF 1 | PK 73 AF 1 | PK 74 AF 1 | |
| Ro | Ro S | quot. | quot. | quot. | |
| | Ro - | 400 °C | 500 °C | 250 °C | |
| | Ro - | 2000 °C | 2500 °C | 1700 °C | |
| | Ro04 | 4-20 mA | 4-20 mA | 4-20 mA | |
| do | doSP | 1000 °C | 1000 °C | 1000 °C | |
| | do r P | 960 °C | 960 °C | 960 °C | |
| | doFN | no | no | no | |
| | do d S | oFF | oFF | oFF | |
| | do d r | oFF | oFF | oFF | |
| EF | EPS | 100.0 | 100.0 | 100.0 | |
| | PhLd | oFF | oFF | oFF | |
| | dRP | oFF | oFF | oFF | |
| | d, SP | on | on | on | |
| | Unit | °C | °C | °C | |

More information at www.keller.de/its

23 Copyright

The device software contains portions of the avr-libc library.

Portions of avr-libc are Copyright (c) 1999-2007

Keith Gudger,
Bjoern Haase,
Steinar Haugen,
Peter Jansen,
Reinhard Jessich,
Magnus Johansson,
Artur Lipowski,
Marek Michalkiewicz,

Colin O'Flynn,
Bob Paddock,
Reiner Patommel,
Michael Rickman,
Theodore A. Roth,
Juergen Schilling,
Philip Soeberg,
Anatoly Sokolov,

Nils Kristian Strom,
Michael Stumpf,
Stefan Swanepoel,
Eric B. Weddington,
Joerg Wunsch,
Dmitry Xmelkov,
The Regents of the
University of California.

EN

All rights reserved.

Redistribution and use in source and binary forms, with or without modification, are permitted provided that the following conditions are met:

- * Redistributions of source code must retain the above copyright notice, this list of conditions and the following disclaimer.
- * Redistributions in binary form must reproduce the above copyright notice, this list of conditions and the following disclaimer in the documentation and/or other materials provided with the distribution.
- * Neither the name of the copyright holders nor the names of contributors may be used to endorse or promote products derived from this software without specific prior written permission.

THIS SOFTWARE IS PROVIDED BY THE COPYRIGHT HOLDERS AND CONTRIBUTORS „AS IS“ AND ANY EXPRESS OR IMPLIED WARRANTIES, INCLUDING, BUT NOT LIMITED TO, THE IMPLIED WARRANTIES OF MERCHANTABILITY AND FITNESS FOR A PARTICULAR PURPOSE ARE DISCLAIMED. IN NO EVENT SHALL THE COPYRIGHT OWNER OR CONTRIBUTORS BE LIABLE FOR ANY DIRECT, INDIRECT, INCIDENTAL, SPECIAL, EXEMPLARY, OR CONSEQUENTIAL DAMAGES (INCLUDING, BUT NOT LIMITED TO, PROCUREMENT OF SUBSTITUTE GOODS OR SERVICES; LOSS OF USE, DATA, OR PROFITS; OR BUSINESS INTERRUPTION) HOWEVER CAUSED AND ON ANY THEORY OF LIABILITY, WHETHER IN CONTRACT, STRICT LIABILITY, OR TORT (INCLUDING NEGLIGENCE OR OTHERWISE) ARISING IN ANY WAY OUT OF THE USE OF THIS SOFTWARE, EVEN IF ADVISED OF THE POSSIBILITY OF SUCH DAMAGE.

Copyright prohibits the reproduction or distribution of this instruction manual, including text, photographs or images contained herein, in whole or in part, for any purpose whatsoever, without prior consent of the author. This applies to any form of mechanical or electronic reproduction as well as to electronic transmission in any form through any medium.

Please note:

Unless otherwise stated in this instruction manual, the instruments described herein are subject to change without prior notice, particularly modifications for the sake of technological advancement.

© 2018 KELLER HCW GmbH
Carl-Keller-Straße 2-10
D-49479 Ibbenbüren-Laggenbeck
Germany
www.keller.de/its

